

Service Manual

# 100 Series



AHE-125-DN2



**Contents**

Caution Notes.....2  
 Introduction .....3  
 Maintenance Schedule.....6  
 System Features .....7  
 Component Cut-Aways .....9  
 Operational Flowchart.....11  
 Operating the Aqua-Hot & LCD ..... 12  
 Aqua-Hot Controller..... 14  
 Controller Replacement Procedure.....18  
 Fluid Level Sensor .....21  
 High-Limit Thermostats..... 23  
 Low-Temperature Cutoff Thermostat.....25  
 Three-Way Valve ..... 26  
 Tempering Valve ..... 28  
 Fluid Circulation Pump..... 30  
 AC Electric System..... 32  
 AC Relay ..... 34  
 ETS Module ..... 35  
 Fuel System Replacement.....37  
 Fuel System Purge Procedure ..... 39  
 Burner Troubleshooting ..... 40  
 Burner Operation after Service ..... 43  
 General Troubleshooting..... 44  
 Winterization..... 45  
 Appendix A: System Schematics ..... 46  
 Appendix B: Parts..... 50  
 Appendix C: Measuring Antifreeze ..... 55

**Caution Notes**

As you read this information, take particular note of the NOTICE, CAUTION, WARNING, and DANGER symbols when they appear. This information is important for safe and efficient use of the Aqua-Hot system.

**NOTICE** signals a situation where potential damage to the Aqua-Hot could occur.



**CAUTION** signals a situation where potential harm or risk of minor or moderate injury could occur if you do not follow instructions.



**WARNING** signals a hazardous situation where potential harm, risk of serious injury, or death could result if instructions are not followed.



**DANGER** signals a situation where immediate risk of serious injury or death will result if instructions are not followed.



**NOTE:** This manual will also use notes sections similar to this one to draw attention to features and practices which must be observed.

## System Overview

The Aqua-Hot 125 Series is a Hydronic Heating System that can provide heat and hot water on demand using a built-in electric heating element and an external diesel burner.

### The Aqua-Hot Heating is a 2-in-1 System

1. Interior heating system: provides quiet, comfortable interior heat and even temperatures.
2. Tank-less hot water system: provides a flow of comfortable hot water.

The Aqua-Hot heating system heats an ethylene glycol-based antifreeze (50%) and distilled water solution (50%) that is stored in the Aqua-Hot's boiler tank. This fluid solution must be up to operating temperature before the Aqua-Hot will provide interior heat or hot water. The tank-less hot water system produces approximately 0.8 GPM of hot water. This system is also hot water priority, so it will shut off the heat any time hot water is called for.

Once the fluid is to temperature (180°F), a fluid circulation pump transports the heated glycol/water mixture through the heating loop and to heat exchangers to evenly warm the RV. Water is heated on-demand by going into a heat exchanger

located in the Aqua-Hot. The water is heated by transfer from the heated antifreeze and distilled water solution. The heated domestic water then flows through the tempering valve to be mixed with cool water from the fresh water tank to achieve an appropriate temperature before it flows to the faucet.

To get the Aqua-Hot to temperature, turn the electric heating element and/or the external diesel burner to the "ON" position on the Aqua-Hot LCD screen, or on the RV control panel. It may take up to 20 minutes to get to operating temperature before heat or hot water are available.

For continuous hot water or heat in colder conditions, it is recommended to utilize the external diesel burner. The electric heating element will provide heat only in mild conditions and provide light duty hot water needs.

Should additional assistance be needed, please contact the Technical Support at (800) 685-4298, Monday through Friday, between 7:00am and 4:00pm MST.

**NOTE:** The image below is just a sample for mounting locations of the Cozy heat exchangers, burner, and Aqua-Hot. Actual placement and quantity may vary on the individual design of the RV. For questions or assistance, contact Aqua-Hot at (800) 685-4298.

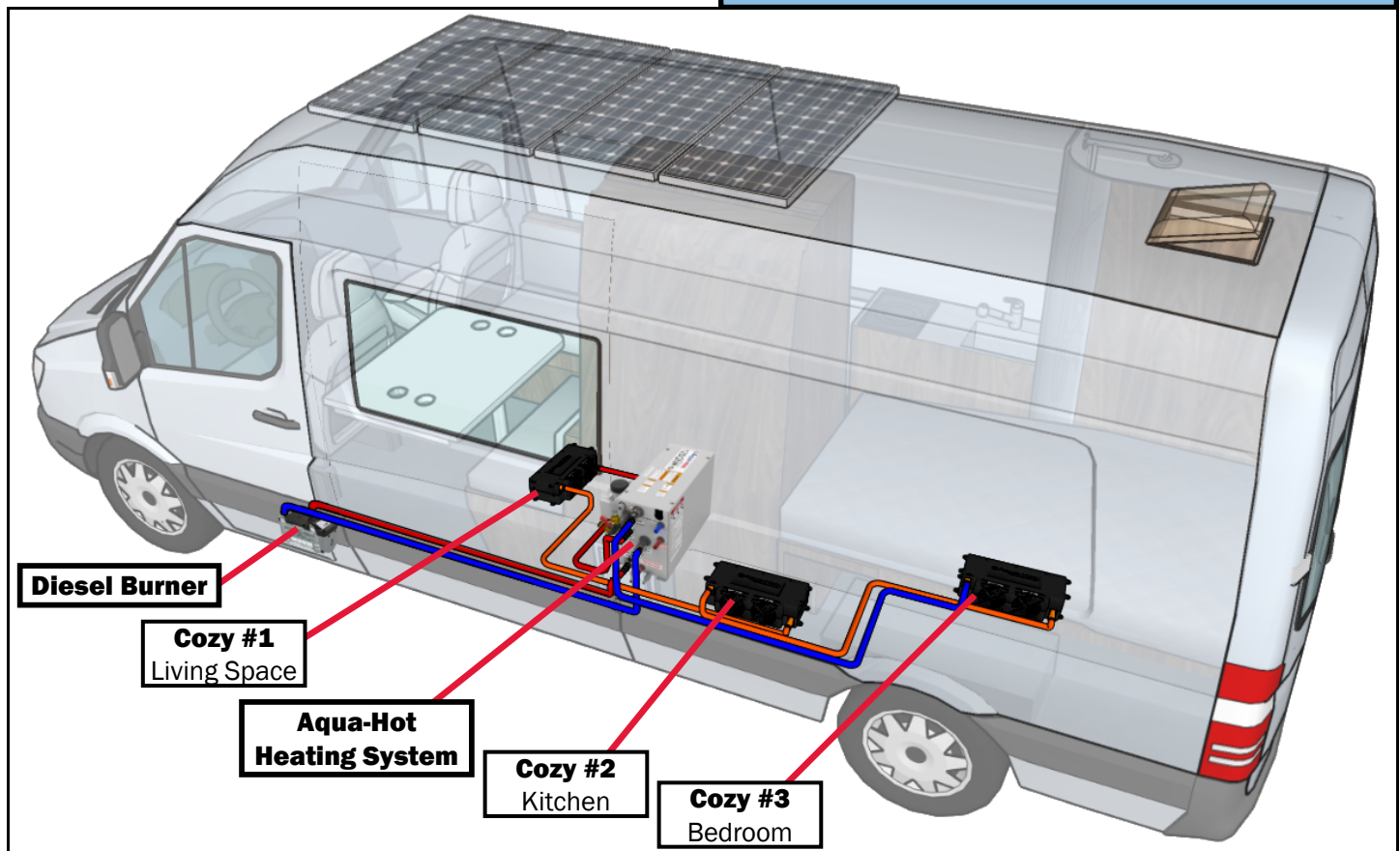

**Figure 1**

**Heat Priority Option:**

The Aqua-Hot comes equipped with the three-way valve (sometimes known as the summer/winter valve). This controls the flow of the antifreeze and water heating solution within the Aqua-Hot to deliver either hot water or interior as priority. Tapping on this element will change the valve's orientation. When this element displays "INT. HEAT", this valve is oriented to provide interior heat by circulating the heating solution throughout the interior heating zone. When the element says "HOT WATER", the valve is oriented so that the heating solution is routed to prioritize hot water.

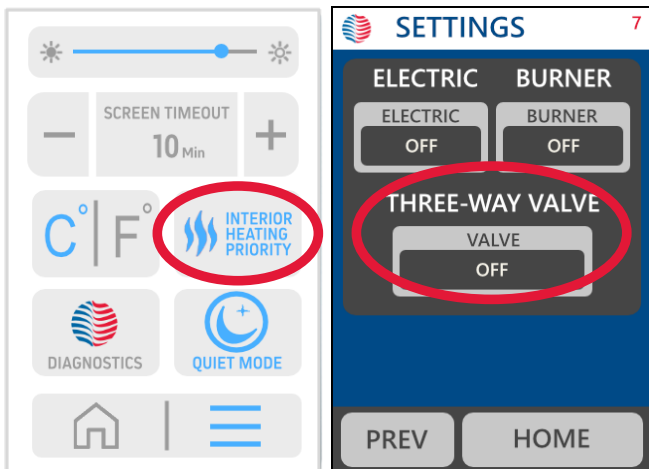

**Figure 2**

**NOTE:** Aqua-Hot recommends regular exercise of the Aqua-Hot heating system to avoid issues with starting after a several-month idle period.

DANGER

**Fuel can cause fire or explosion that can create severe personal injury or death. Do not store/transport a remote fuel tank *inside* the RV. Notice all applicable codes and regulations for storage, transporting, and handling of remote fuel tanks. Follow instructions to ensure safe operation and check for fuel leaks before operating the burner.**

**External Diesel Burner:**

The diesel burner is the Aqua-Hot's primary and most powerful heat source, and provides all of the heating and hot water needs when cold temperatures exist, and/or when there is a high demand for hot water. It can be activated by turning the burner on by tapping BURNER to ON on the LCD screen shown below.

The burner has 2 modes: ON and OFF. When the burner is ON, the burner will keep the tank temperature between 160°F and 180°F. The burner will toggle between ON and OFF as needed, using temperature readings from the RV interior thermistors. In OFF mode, the burner is off and will not provide any heat to the Aqua-Hot tank.

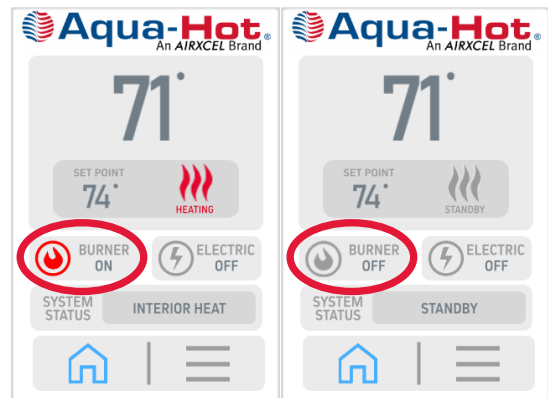
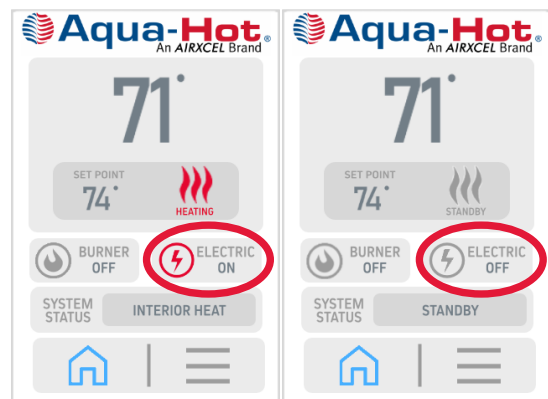

**Figure 3**

**Electric Element:**

The electric element is the Aqua-Hot's secondary heat source and can be used when plugged into shore power. The electric element will work to maintain tank temperature at 5°F below the heater activation threshold. It can be activated by tapping on the ELECTRIC button of the LCD screen interface.

The electric element has 2 modes: ON and OFF. When the electric element is ON, the electric element will keep the tank temperature between 165°F and 180°F. The electric element will toggle between ON and OFF as needed, using temperature readings from the RV interior thermistors. In OFF mode, the electric element is off and will not provide any heat to the Aqua-Hot tank.



**Figure 4**

## Introduction to this Document

Welcome to the Aqua-Hot 125-DN2 Service Manual. This manual will serve as a guide for diagnosing and repairing the Aqua-Hot, how to perform standard maintenance, and guide you through troubleshooting procedures to repair the Aqua-Hot. This service manual is designed to aid trained and qualified technicians to properly service and troubleshoot the Aqua-Hot 125-DN2.

Each section in this manual is dedicated to the diagnosis of specific components within the Aqua-Hot which may be inhibiting the operation of the heater.

Troubleshooting and diagnosis of the Aqua-Hot is most efficiently and effectively accomplished with the Aqua-Hot LCD display, which will relay in plain-language, diagnosis of many Aqua-Hot related issues.



**Figure 5**

If additional assistance is needed in diagnosing and repairing the Aqua-Hot, please contact our Technical Service Department at 574-AIR-XCEL (574-247-9235) from 7:00am to 4:00pm MST Monday through Friday.



### WARNING!

Read and understand all instructions **before** servicing the Aqua-Hot unit and the external diesel burner. Aqua-Hot Heating Systems is not liable for damage resulting from failing to follow instructions contained in this, and any other Aqua-Hot documentation relevant to this unit.

Improper installation, adjustments, service, and maintenance can cause personal injury or loss of life. Reference the service and user manuals **before** maintenance or service.

**NOTE:** Contact your Authorized Service Center or Aqua-Hot Heating Systems if you have any questions **before** starting any service or maintenance. Information can be found online at [www.aquahot.com](http://www.aquahot.com).

- The product identity label contains specifications of the unit, to what standards it has been tested, and important safety notices.
- Disconnect electric wiring to the Aqua-Hot System before welding or plasma cutting the RV to avoid damage to equipment.
- The Aqua-Hot tank and heating loop operate at 0 PSI (zero pressure system). Air pressure to the tank must not exceed 18 PSI. Exceeding this rating will cause internal damage to the Aqua-Hot.
- Use caution when working on or near any diesel systems.
- DO NOT connect the 12-volt DC power to the Aqua-Hot if the vehicle requires welding.
- At maximum operating temperature, the coolant and vapor will be very hot and scalding that may result in serious burns or injury. Be aware of hot surfaces.
- Use special caution when children are present. Children must not be allowed to play with the heater or perform cleaning and/or maintenance.
- Installation and repairs may only be carried out by an authorized, factory-trained Aqua-Hot technician. The heating system must be serviced in accordance with local codes, or, in the absence of local codes, follow NFPA 1192. National safety regulations must be adhered to.

## Maintenance Schedule

### Monthly Maintenance

Check the Aqua-Hot's antifreeze and distilled water heating solution to ensure that it is at the proper level. This can be accomplished by visually checking the coolant level in the Aqua-Hot's expansion bottle; reference Figure 87 on page 44.

Please note that the coolant level should ONLY be checked when the Aqua-Hot is at maximum operating temperature. This should be done immediately after the electric element disengages, or after the gas burner has completed a cycle.

At maximum operating temperature, the antifreeze and distilled water heating solution should be at the level marked "HOT" on the expansion bottle.

**NOTE:** It is also recommended to run the diesel burner at least once a month for a full cycle (at least 20 minutes) to ensure optimum heater condition.

### Annual Maintenance

To maintain the Aqua-Hot at its full potential, it is highly recommended to have the gas burner tuned up annually. This involves cleaning the burner, replacing the fuel filter, inspecting the exhaust and combustion air lines for damage and ensure they are clear, checking the fuel lines for any leaks, and checking the hoses and wiring to make sure there is no damage or cracks.

### Replenishing the Heating Solution

If the antifreeze and water heating solution needs replenishing, remove the expansion bottle cap and fill it to the "HOT" mark. Replace the expansion bottle cap when this is complete. DO NOT operate the unit without first replacing the cap of the bottle. Reference Figure 87 for additional information. Excess air will escape through this bottle as the stir pump of the unit operates. While bleeding this system of air, it will be necessary to continue to fill the bottle until this process is complete.

The Aqua-Hot does not need regular replacement of the antifreeze and water heating solution, but in the event that more antifreeze is required, contact Aqua-Hot Heating Systems to purchase antifreeze, or for guidance in selecting an appropriate antifreeze product for use with this unit.

DANGER

When the Aqua-Hot is at maximum operating temperature, the coolant is very hot. If the Aqua-Hot heating system is accessed, scalding by hot vapor or coolant may occur. Before cleaning or servicing, disconnect all power supplies.

# WARNING

**DO NOT operate the diesel burner and/or electric heating element without antifreeze and distilled water heating solution present in the Aqua-Hot's boiler tank. Doing so will cause serious damage to the heater.**

### Overheat Protection

Every Aqua-Hot is equipped with at least two overheat protection devices. These are commonly known as the high-limit thermostats. These thermostats operate by maintaining a circuit while the unit is below 218°F.

In the event of an overheat condition, the high limit thermostats will cut the operating signal to the gas burner, and/or the electric element. When this signal is interrupted, the electric element and gas burner will immediately disengage. Contact Aqua-Hot Heating Systems LLC for assistance in locating a qualified person to service this heater after an overheat situation.

# WARNING

**DO NOT attempt to reset the high-limit thermostats after an overheat condition until the unit has been serviced by a qualified technician. Failure to do so could result in damage to the unit, personal injury, or death.**

In order to provide the best freeze protection, boil-over protection, anti-corrosion, and rust protection, a mixture of 50/50 ethylene glycol antifreeze and distilled water is recommended. The Aqua-Hot 125GN boiler tank holds approximately 1.8 gallons.

The mixture may be modified to provide the most adequate freezing, boiling, and rust/anti-corrosive protection. A 50/50 mixture of ethylene glycol and distilled water has a freeze point of approximately -35°F and a boiling point of approximately 223°F. Refer to the table below to determine the best protection mixture ratio and also reference page 55 for the proper tool and instructions for use in measuring the system's antifreeze mixture ratio.

Ethylene Glycol to Distilled Water Ratio												
Freeze Point (°F)	32	25	20	15	10	5	0	-10	-20	-30	-40	-50
Concentration (%)	0	10	16	21	25	29	33	39	44	48	52	56



Exhaust system MUST NOT terminate beneath the vehicle and not less than 3 feet from an openable window.

Combustion Air MUST BE supplied from outside the vehicle.

Suitable for water (potable) heating and space heating.

THIS APPLIANCE OPERATES ON BOTH DC AND AC POWER.

**USE COPPER CONDUCTORS ONLY!**

Use a circuit breaker that cuts power at 20-Amps maximum for over-current protection for the 120-VAC power supply.

Mount the Heater and Unit so that the Access cover can be easily removed for service.

For Detailed Information, reference the Owner's Manual or contact Aqua-Hot Heating Systems Inc. at 574-AIR-XCEL (574-247-9235).

Minimum Service Clearances  
 Front - Open Access  
 Back - 1 Inches  
 Top - 8 Inches  
 Sides - 1 Inches

This appliance must be installed in accordance with local codes or, in the absence of local codes, the Standard for Recreational Vehicles, ANSI A119.2/NFPA 1192 or CAN/CSA-Z240 RV



Meets or Exceeds: **UL 307B, UL 174**  
**CSA/CAN B140.0-03**  
**CAN/CSA-C22.2 No. 110-94**

Listing 20L01

Max Tank Pressure	0 PSI
Watts (DC)	84W
Watts (AC)	1500W
Tank Capacity	1.8 gal (Ethylene Glycol)
Volts/Amps	12VDC, 7A
Volts/Amps/Frequency	120VAC, 13.75A, 50/60Hz
Burner Model	5kW Diesel Burner
Burner Fuel	DIESEL
Burner Rating	17,060 BTU/hr

Model Number: AHE-125-DN2

Serial Number: A125DN-220000

Burner Serial Number: XXXXXXXXXXXXXXX

7755 Miller Drive • Frederick, CO 80504 • 574-AIR-XCEL • www.aquahot.com

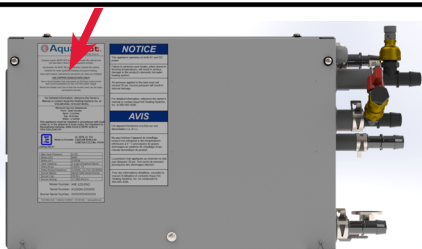

**NOTE:** This product label is attached to the side of the Aqua-Hot, and provides a ready reference to specifications, test standards, and important safety notices.



Figure 6

### System Specifications

#### Electric Element

Power Consumption .....1500 W (maximum)  
 Voltage ..... 110V AC

#### DC Power

Power Consumption ..... 57 W (maximum)

#### Zone Heat Circulation

Pumps ..... 1  
 Power Consumption (max).....20W/1.7A  
 Voltage ..... 12V DC

#### Interior Heating

Maximum Heating Zones.....3  
 Cozy.....6W/0.5A - 8,000 BTU/hr  
 Whisper.....4.5W/0.37A - 4,000 BTU/hr  
 H.E. II.....3W/0.25A - 4,000 BTU/hr

**NOTE:** Control Panel "Quiet Mode" reduces heat exchanger power consumption by 20%

#### Domestic Water Heating

Maximum ..... 0.8 GPM

#### Physical Specifications

Dimensions (US).....17.66" L x 7.50" W x 11.50" H  
 Dry Weight .....45lbs.  
 Wet Weight.....59lbs.

All vehicle installations must comply with the requirements listed in the Recreational Vehicle Industry Association's (RVIA) ANSI/NFPA 1192 Handbook for Recreational Vehicle Standards.

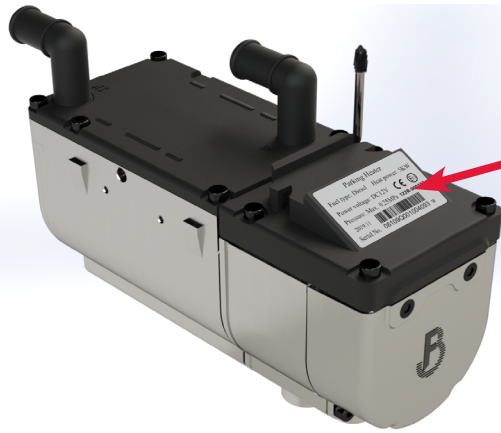

**Figure 7**

**Parking Heater**

Fuel type: Diesel    Heat power: 5KW

Power voltage: DC12V   

Pressure: Max. 0.25MPa    **122R-000192**

2019.11   

Serial No. 08109Q001004093 w

**NOTE:** This product label is attached to the top of the burner and provides a ready reference to specifications, test standards, and important safety notices.

## System Specifications

### Diesel Burner

Heat Flow.....5,188 to 17,060 BTU/hr  
 Diesel Fuel Consumption.....0.07 to 0.16 gal/hr  
 Coolant Pump.....20W/1.7A  
 Operating Pressure (med heat).....36.25 PSI  
 Flow Rate (minimum).....36.25 PSI  
 Working Altitude ..... 16,000ft

### Fuel

Fuel Type.....**DIESEL**  
 Fuel Consumption (Low Output)..... 0.07g/h  
 Fuel Consumption (High Output)..... 0.16g/h

### DC Power

Consumption .....10 to 37W  
 Operating Amp Range..... 0.83 to 3.8A

### Operating Temperatures

Burner Operation ..... -40 to 176 °F  
 Burner Storage.....-40 to 248 °F  
 Fuel Pump Operation ..... -40 to 86 °F  
 Fuel Pump Storage.....-40 to 194 °F

### Physical Specifications

Dimensions..... 8.8”L x 3.4”W x 6.9”H  
 Weight.....6.3 lbs

<b>TECHNICAL SPECIFICATIONS</b>	
<b>Heating Medium</b>	Ethylene Glycol/Distilled Water
<b>Thermal Power (W)</b>	High Power Operation: 5000W
	Low Power Operation: 2400W
<b>Fuel</b>	DIESEL
<b>Fuel Consumption (gallons per hour)</b>	Low power operation: 0.07 g/h High power operation: 0.16 g/h
<b>Power supply (battery for the engine)</b>	DC12V
<b>Power Consumption (W)</b>	At start <100 W
	High power operation: 37 W
	Low power operation: 10 W
<b>Working pressure (MPa)</b>	0.25
<b>Lowest working temperature</b>	-40 °F
<b>Net Weight (heater only)</b>	10.6lbs
<b>Working height (above sea level)</b>	16,405 ft
<b>Weight of Main Heater</b>	6.3lbs

All vehicle installations must comply with the requirements listed in the Recreational Vehicle Industry Association’s (RVIA) ANSI/NFPA 1192 Handbook for Recreational Vehicle Standards.



- | Aqua-Hot 125-DN2 |  |
|------------------|--|
| 1.               | Fluid Circulation Pump                     |
| 2.               | Tempering Valve                            |
| 3.               | Aqua-Hot Controller                        |
| 4.               | Antifreeze and Water Heating Solution Tank |
| 5.               | AC Electric Element                        |
| 6.               | AC Activation Relay                        |
| 7.               | Plate-to-plate Heat Exchanger              |
| 8.               | Three-Way Valve                            |
| 9.               | Zone Air-Bleed Valve                       |
| 10.              | Fluid Expansion Port (to overflow bottle)  |
| 11.              | Zone Return                                |
| 12.              | Fluid Fill Port                            |
| 13.              | Zone Supply                                |
| 14.              | Service Panel                              |
| 15.              | External Diesel Burner Supply              |
| 16.              | External Diesel Burner Return              |
| 17.              | Domestic Cold-Water Inlet                  |
| 18.              | Domestic Hot-Water Outlet                  |
| 19.              | Domestic Low Point Drain                   |
| 20.              | Cabinet Drain                              |

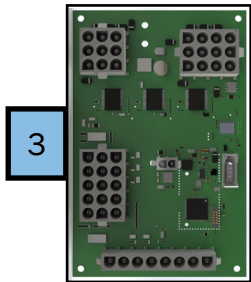

Figure 9

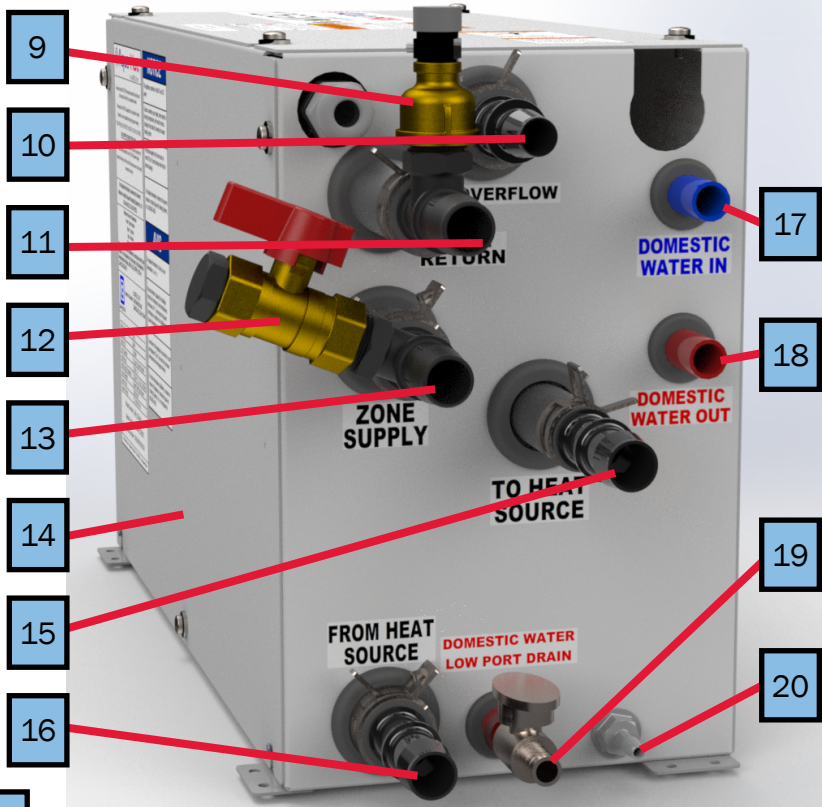

Figure 10

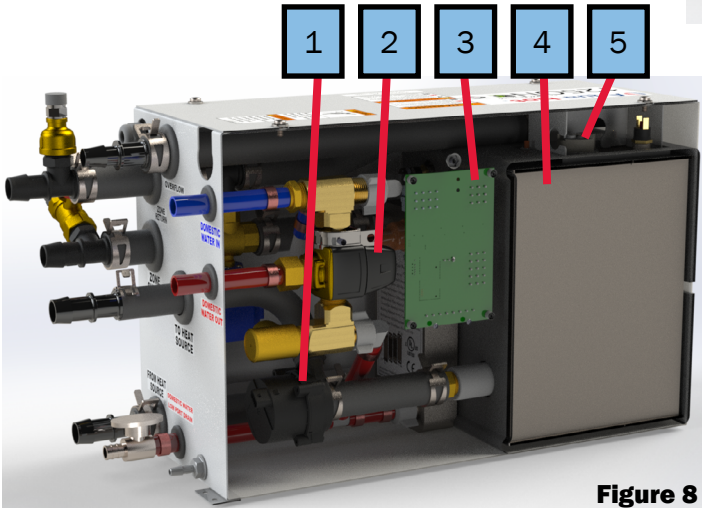

Figure 8

**NOTE:** The side panel in the view above has been made transparent to aid in the explanation of the heater. DO NOT remove this side panel. Doing so risks irreparable damage to the Aqua-Hot. Only remove the service panel for service.

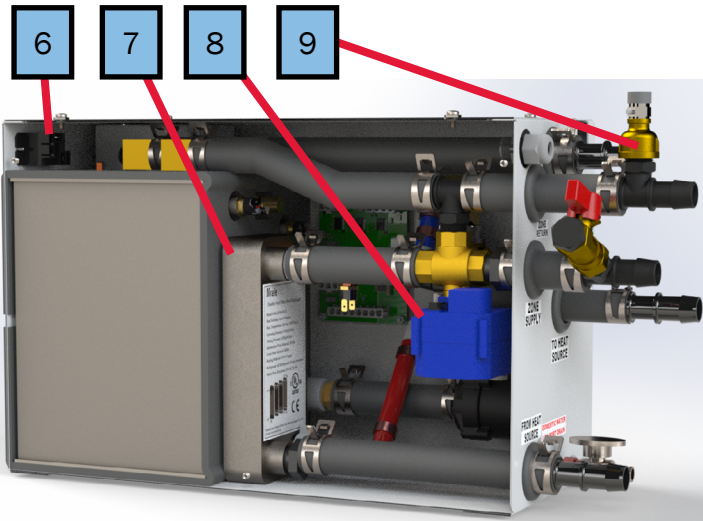

Figure 11



Figure 12

Diesel Burner	
1. Combustion Air Fan	12. Fuel Pipe
2. Burner Outer Casing	13. Coolant Pump
3. Burner Inner Casing	14. Fuse
4. Combustion Chamber	15. Main Wire Harness Connector
5. Glow Plug	16. Fuel Pump
6. Flame Sensor	17. Exhaust Pipe
7. Temperature sensor	18. Coolant outlet Pipe
8. Over-Heat Sensor	19. Coolant Inlet Pipe
9. Burner Controller	20. Burner
10. Air Inlet Pipe	21. Diesel Fuel Filter



Figure 13

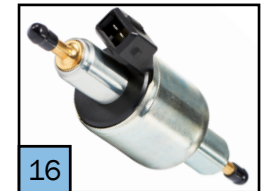

Figure 14

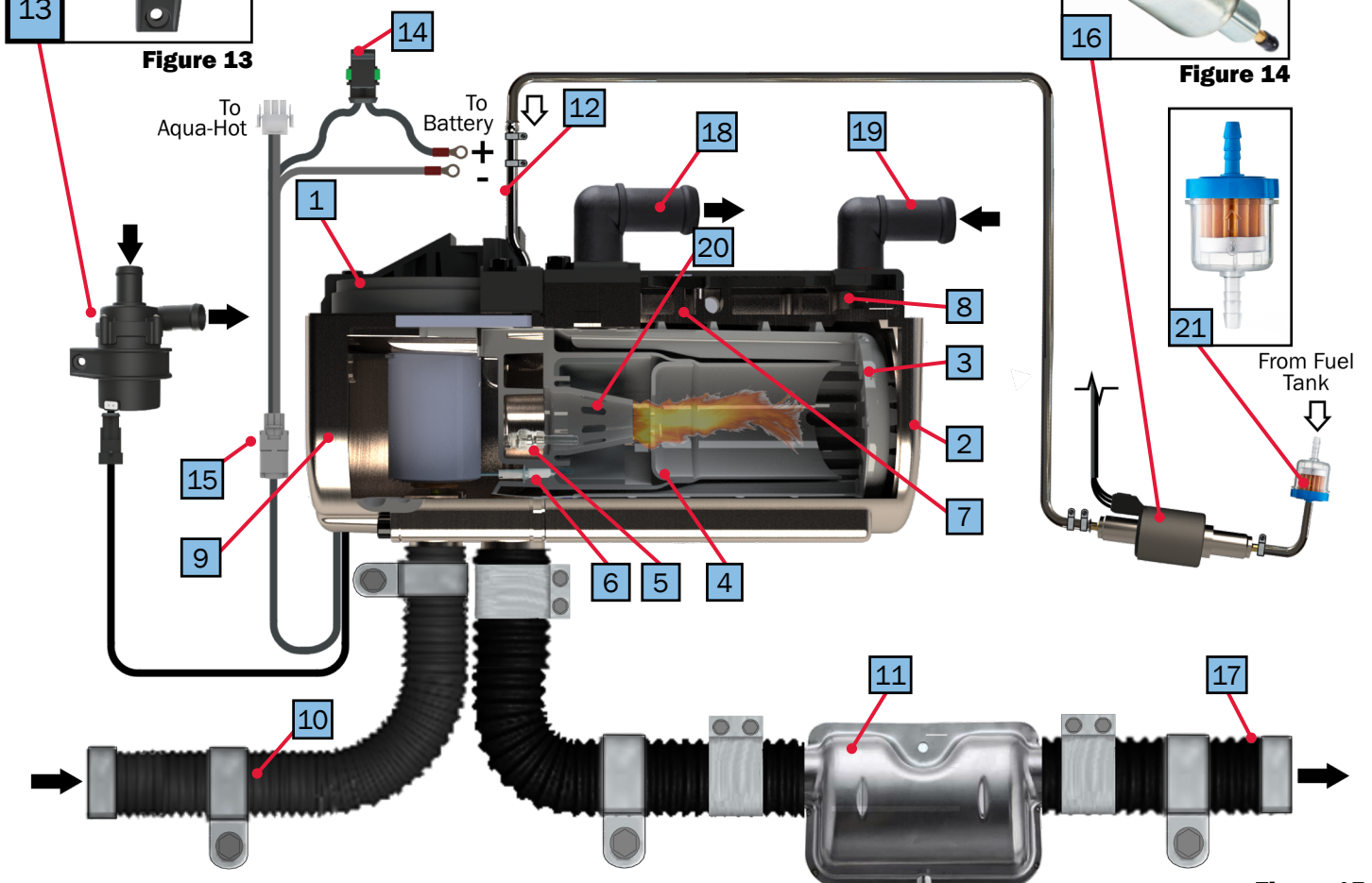
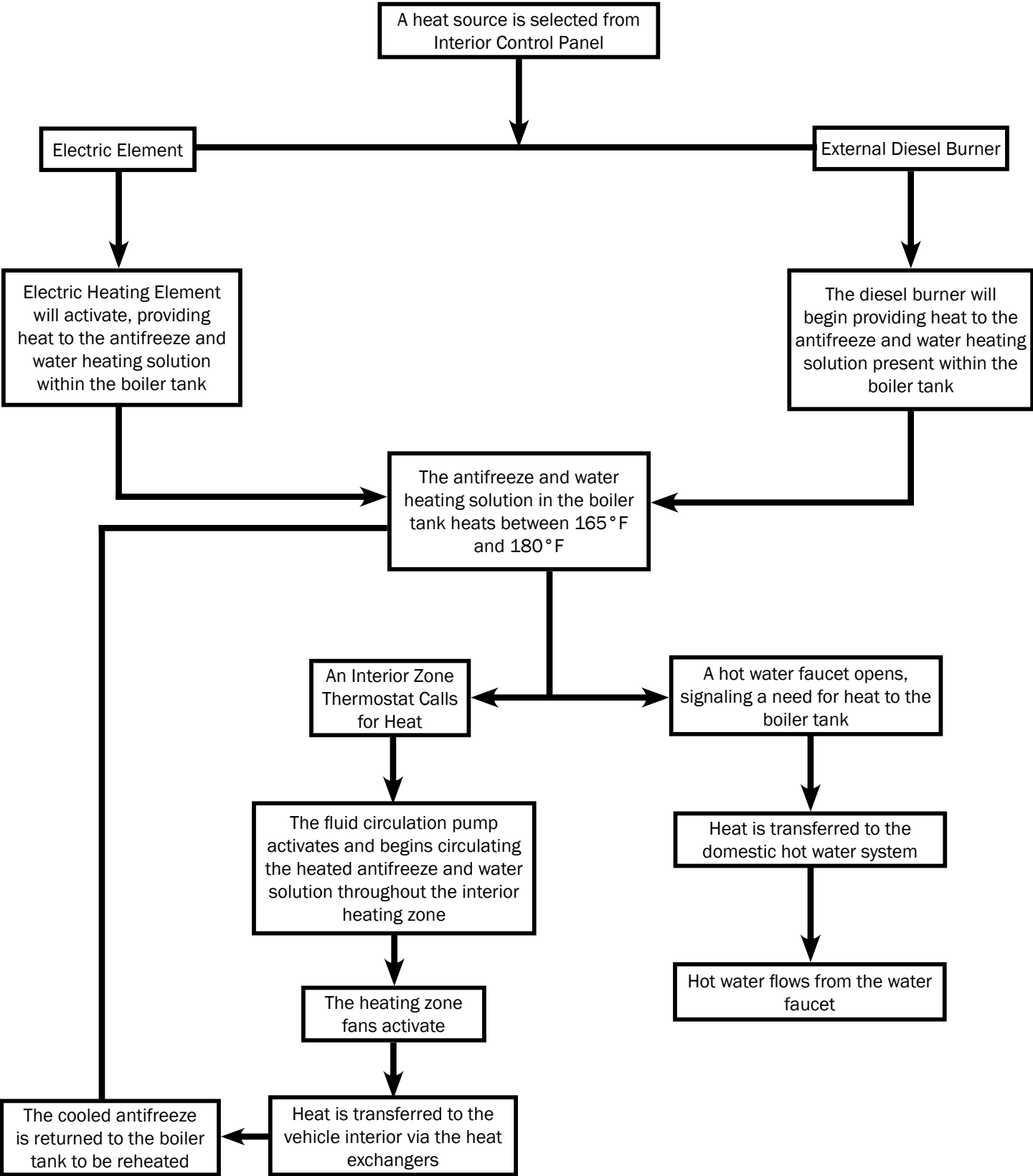

Figure 15

### Operational Flow Chart



## Operating the Aqua-Hot & LCD

### Introduction:

This document will outline the basic operating instructions for the Aqua-Hot LCD Screen.

### Climate Pages:

The climate pages are for all intents and purposes the “Home” of the LCD screen. From here, the end-user will select their interior temperature set-points, activate or deactivate the diesel burner and/or the electric element.

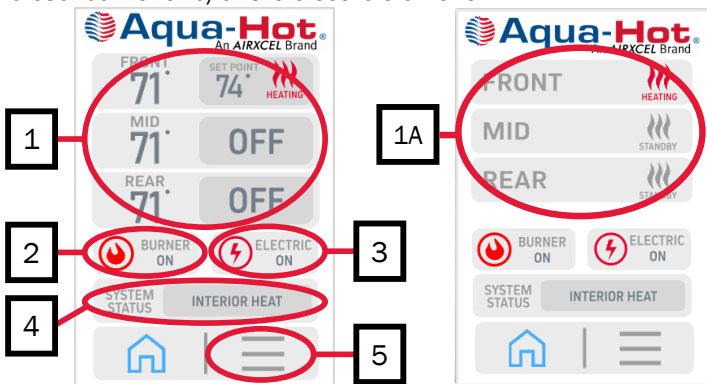

### Zone Control (1):

Precise zone control display will differ depending on the type of zone thermostats used within the RV.

Section 1A demonstrates the appearance of the zone control section when ON/OFF thermostats are used within the RV. In this use-case, these buttons serve only as ON/OFF toggle switches.

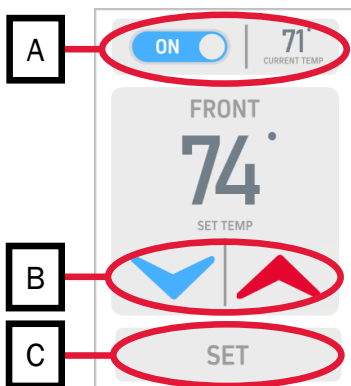

Tapping on one of the zones shown above will display a new screen where the interior temperature can be set.

### Section A:

This section shows the current zone temperature (shown as 71° F in the example above) as well as a button to turn the zone on or off. (Setting specific temperatures can

only be done *if* thermistors are installed. Thermostats would only show ON/OFF.)

If the zone temperature is set, but this item is not set to ON, the zone heat exchanger will not activate.

### Section B:

These arrows are used to increase or decrease the desired set-point temperature of the zone thermistor.

### Section C:

After the desired temperature set-point has been selected tap “SET” on the LCD to set that temperature. The Aqua-Hot will now work to maintain this interior temperature, and the screen will return home.

### External Diesel Burner Activation (2):

The external diesel burner of the Aqua-Hot can be activated by tapping on the “burner” item on-screen. The diesel burner has two modes; ON and OFF.

### ON:

While set to ON, the Aqua-Hot diesel burner will work to maintain a tank temperature of 180° F, with a minimum tank temperature of 160° F.

### OFF:

While off, the diesel burner will not serve to provide any heat to the boiler of the Aqua-Hot whatsoever.

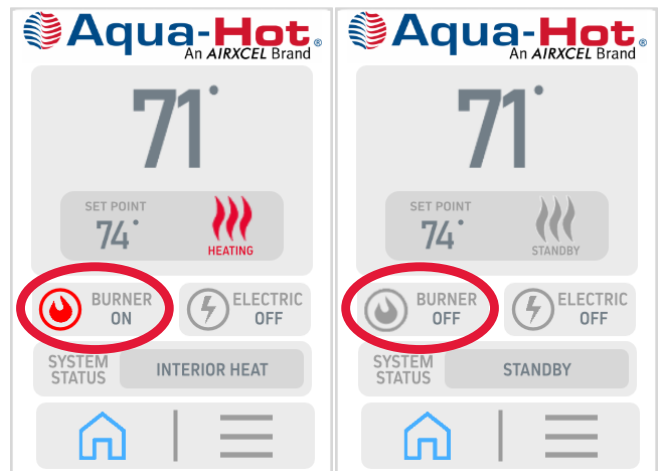

**Electrical Element Activation (3):**

Similar to the external diesel burner, tapping the electric item will signal to the controller to activate the AC electric relay, energizing the 1500W electric element within the Aqua-Hot. The electric element also has two modes: ON and OFF.

**ON:**

While set to ON, the electric element will work to maintain a tank temperature of 180° F, with a minimum tank temperature of 165° F.

**OFF:**

While off, the element will not serve to provide any heat to the boiler of the Aqua-Hot whatsoever.

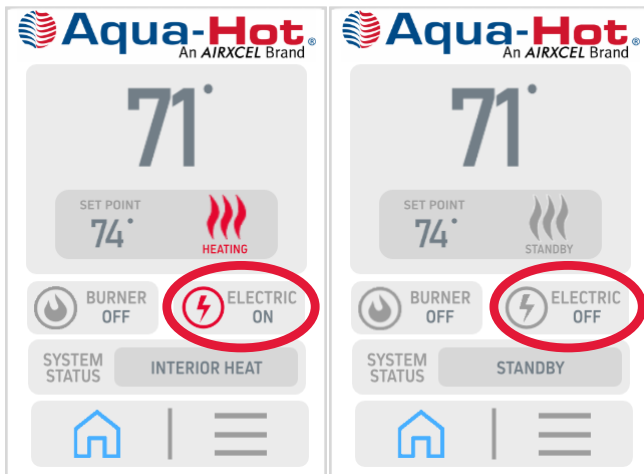

**System Status (4):**

This item will indicate the current operational status of the Aqua-Hot. If any faults have triggered, those will be displayed here.

During normal operation, this should display either INTERIOR HEAT or HOT WATER relating to the priority and position of the 3-way valve.

While in INTERIOR HEAT mode, the 3-way valve is oriented so as to circulate heated antifreeze and water solution through the heating zones of the RV.

While in HOT WATER mode, the 3-way valve is oriented so that the heated antifreeze and water solution is circulated immediately back into the boiler tank. This is known as “stirring” the tank, and it is done to provide as much heat as possible to the domestic water line while water is flowing.

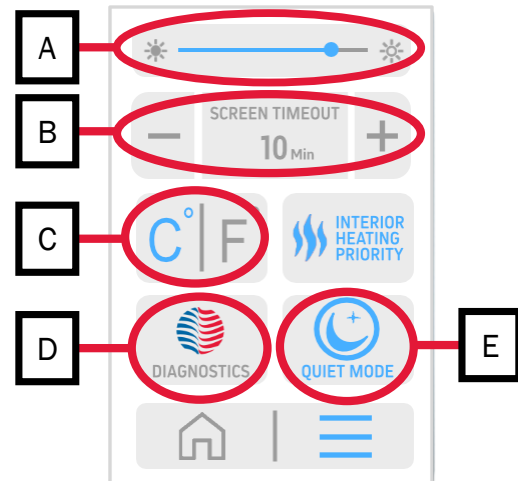

**Module Options (5):**

Tapping on the module options screen (the 3 lines on the bottom right of the home screen) will display the screen shown above. This is known as the Module Options screen. From here, it is possible to access unit diagnostics, activate Quiet Mode, change the temperature units, adjust screen brightness, and unit timeout.

**Screen Timeout (A):**

The screen timeout item sets the amount of time required to allow the screen to shut-off when idle.

**Screen Brightness (B):**

This setting changes the screen brightness.

**Unit of Measurement (C):**

This setting will change the display units of the Aqua-Hot. Either Fahrenheit or Celsius can be selected.

**Diagnostics (D):**

Tapping on this element will direct you to the Aqua-Hot’s built-in diagnostic, testing, and troubleshooting tools.

**Quiet Mode (E):**

This option toggles the Aqua-Hot’s quiet mode. Quiet mode is a setting where the speed and output of the heat exchanger fans is reduced to 80%. This is done to reduce noise of the heat exchangers.

Please note that this feature must be activated and deactivated as needed.

## The Aqua-Hot Controller

### Introduction:

The Aqua-Hot 125-DN2 operates on a controller platform which has been modernized and updated from the previously used Electronic Controllers and Relay Control Boards of older Aqua-Hot units.

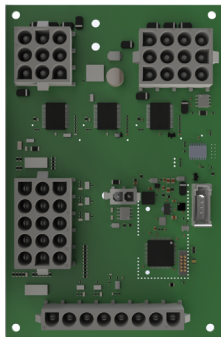

**Figure 16**

This controller is best utilized with the Aqua-Hot 3.5in display. Using the Aqua-Hot with this new display will ensure that you can take advantage of all of the tools and features of this controller.



**Figure 17**

### Features:

This new controller brings with it new features to it which effect functionality from every stage of operation. Fail safe functionality, climate control, and troubleshooting and diagnostics have all been overhauled on this new control architecture. These features will be explained in detail below.

### Troubleshooting:

The new troubleshooting functionality is perhaps the largest and most substantial change to come about from the new controller architecture. Many faults and failures within the Aqua-Hot can now be relayed in plain language to the technician servicing the Aqua-Hot. There are five system faults which will be utilized; System Voltage, Low-Level Cutoff, Over-Current,

Overheat, and Burner Failed to Ignite. These will be explained below.

### System Voltage:

System voltage faults indicate that there is a problem with the RV-side power supply which powers the Aqua-Hot.

The Aqua-Hot can only operate within a voltage range of 11V DC to 16V DC. If voltage drops below 11V, or exceeds 16V DC, the controller will shut down the Aqua-Hot as a safety mechanism.

### Low-Level Cutoff:

The Low-Level Cutoff fault will only trigger if the minimum fluid level within the Aqua-Hot is below an acceptable operational threshold.

If the controller is showing a low-level cutoff fault, begin by diagnosing the float sensor.

### Over-Current:

Over-current faults are triggered by an output channel (pump, fan, etc) that is attempting to draw too much current through the controller. This fault will be accompanied by the component which triggered the fault, for example "PUMP 2 OVER-CURRENT" will display if Pump 2 is not operating correctly.

If over-current faults are appearing on the display, troubleshoot the offending component listed as being over-current.

### Overheat:

Overheat faults indicate that the unit has exceeded its overheat threshold of 210°F.

If an overheat condition has occurred, diagnose the cause of the overheat by investigating the heating sub-systems of the Aqua-Hot (electric and/or diesel burner).

### Under-Current

Under-current faults indicate that the unit does not have enough voltage to properly operate. If voltage drops below 11V, the controller will shut down the Aqua-Hot as a safety mechanism.

If an under-current fault is displayed on the screen, troubleshoot the offending component listed and also check power into the Aqua-Hot.

The fault codes shown above will cover the most common Aqua-Hot related issues. For more complex issues, it may be necessary to utilize the DIAG screens, which will be explained next.

### Diagnostic Screens (DIAG)

The diagnostic screens will show the current operational status of different elements within the Aqua-Hot. By comparing these operational statuses against the expected results it is possible to discern operational issues.

Shown below are the diagnostic screens. From these screens it is possible to see the current status of elements within both the Aqua-Hot and the status of certain elements within the RV such as zone thermostats and on/off signals. Each element on the screens listed below will be explained in detail.

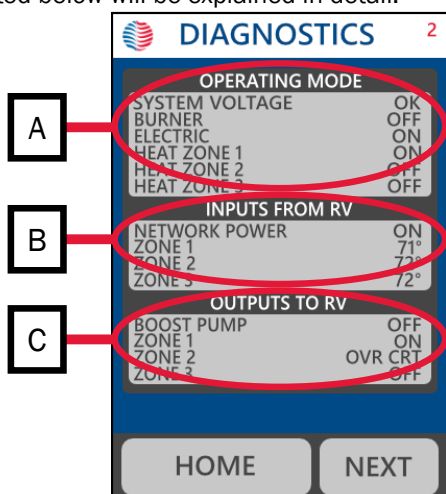

**Figure 18**

#### Operating Mode (A):

The operating mode contains six items which relay at-a-glance information about the function of the Aqua-Hot.

##### System Voltage:

This section of the Operating Mode page indicates the status of the supply voltage to the Aqua-Hot. This will display "OK" if the supply voltage is between 11V DC and 16V DC.

If this element displays anything except "OK" begin troubleshooting the RV-side voltage.

##### Burner:

This indicates the current burner status as either ON, OFF or FAULT. ON indicates that the burner is active, and able to fire to provide heat.

OFF indicates that heat is either not required or not requested by the controller.

FAULT indicates that there is an issue with the burner.

##### Electric:

The Electric section indicates the controller's current handling status of the AC electric relay.

This status indicates that the controller is attempting to activate the element relay only. This does NOT indicate whether the electric element is in working order or not.

##### Heat Zone #:

The next three elements indicate the current status of the heating zones (maximum 3).

This element (ON or OFF) only indicates that the zone thermostat is requesting heat, AND that the controller is providing power to the zone fans.

##### Inputs from RV (B):

The Inputs from RV section will display the signals received from within the RV as pertaining to the RVC network and the heating zone thermostats.

With respect to the zones, there will be three different items displayed next to the Zone # items depending on the type of RV-side thermostat in use.

- ON: This indicates that the zone is active, and the zone thermostat is calling for heat
- OFF: This indicates that heat is either not needed, or not requested by the zone thermostat
- 71°: This indicates the set-point of the RV thermostats. The example in Figure 18 is showing the RV thermostat is requesting it be 71°F in Zone 1. This is only available with certain RV thermostats.

##### Outputs to RV (C):

The Outputs to RV indicates that the controller is sending power to components within the RV. This section may also show faults with components in each zone.

In the example in Figure 18, the controller is not sending power to the boost pump, so the boost pump is shown as OFF.

Zone 1 is ON, meaning that the controller is sending power to the Zone 1 fans.

Zone 2 is Over Current, indicating that there may be a problem with the fans in this zone.

Zone 3 is not active. The controller is not receiving a request for heat from the RV, and it is not powering the zone fans.

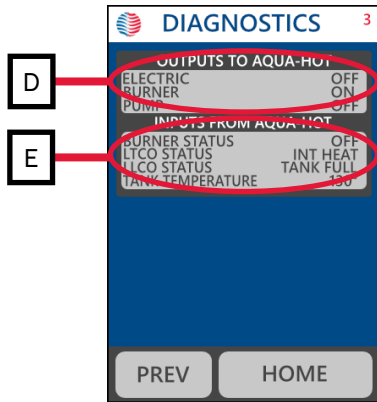

**Figure 19**

**Outputs to Aqua-Hot (D):**

The Outputs to Aqua-Hot section describes the current status of the controllable elements within the Aqua-Hot which are the Burner Status, Fluid Circulation Pump, and the Electric Element.

This indicates only that the controller is attempting to operate these elements, not their current functional status.

**Inputs from Aqua-Hot (E):**

The Inputs to Aqua-Hot will contain the current readings from sensors within the Aqua-Hot. Four elements will be shown on this page; Burner Status, LTCO Status, LLCO Status, and Tank Temperature.

**Burner Status:**

The Burner Status element on this page indicates the status of the external diesel burner.

**LTCO Status:**

The LTCO status indicates the sensor reading from the Low-Temperature Cutoff Thermostat, which is the device that governs whether to provide heat or hot water.

**LLCO Status:**

LLCO status relays the current sensor reading of the Low-Level Cutoff sensor within the overflow bottle.

The LLCO is implemented to measure the fluid level within the overflow bottle to ensure that it does not drop below a safe threshold.

**Tank Temperature:**

The Tank Temperature status will display the current temperature of the antifreeze and water heating solution within the Aqua-Hot.

The ETS Thermistor (short for engine temperature sensor) provides this temperature information to the controller, which then governs when the external diesel burner and/or electric element shut off.

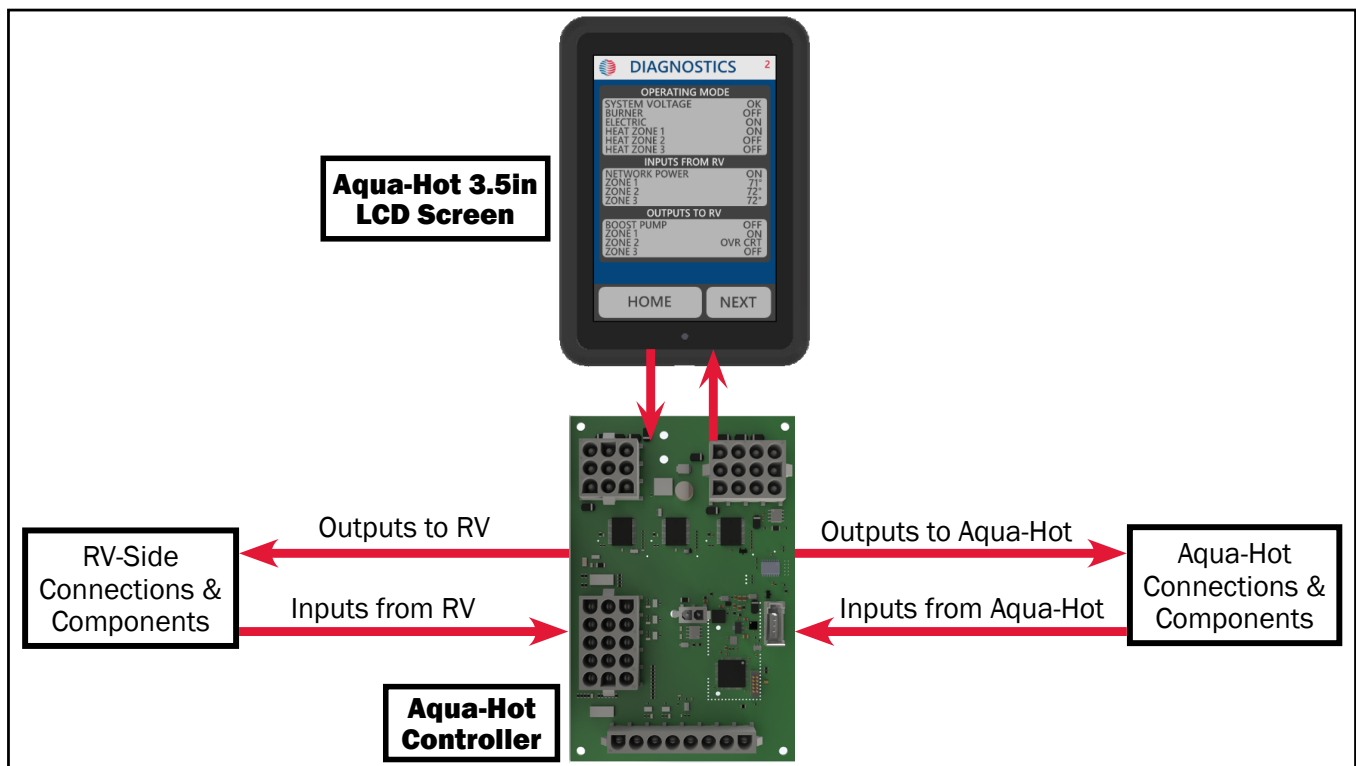
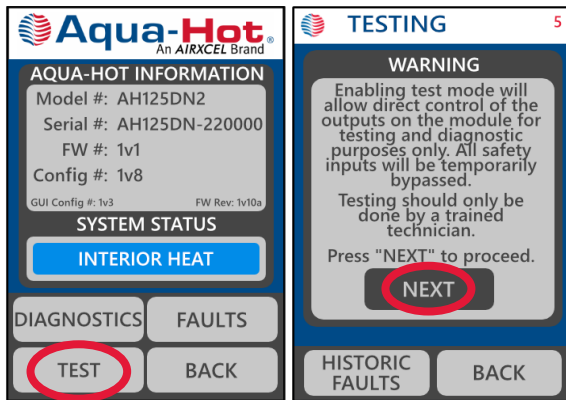

**Figure 20**



### Testing Functionality:

One of the new features of this control system is the ability to independently activate specific elements within the Aqua-Hot for testing purposes.



**Figure 21**

This will allow a technician to activate specific elements within the Aqua-Hot as needed without jumping wires or utilizing external power supplies in most troubleshooting cases. Any elements activated via the testing screen will remain active for a maximum of five minutes.

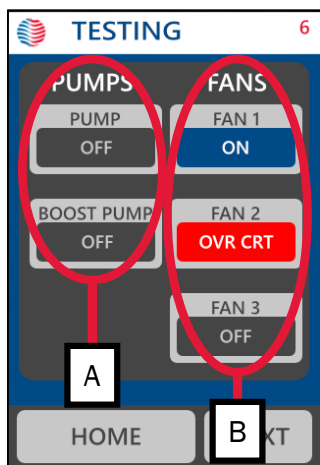
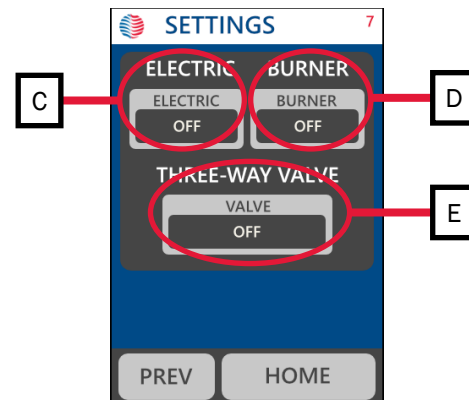

**Figure 22**

Heating sub-systems can be activated independent of their control circuits and other control sensors as a means of testing functionality. These systems will activate for a maximum of five minutes before shutting down.

Activating heating sub-systems in this manner will disregard all sensor inputs while attempting to activate these heating systems. As such, if the unit is near operating temperature, activating these systems may trigger an overheat condition.

**DO NOT attempt to activate these sub-systems while the unit is near operating temperature**



**Figure 23**

#### Electric (C):

Activating the Electric heating sub-system will energize the relay which controls the AC electric element.

After tapping this button on the screen, there should be an audible click from within the Aqua-Hot cabinet. If there is no such click, verify the functionality of the AC electric relay.

This test CANNOT directly energize the AC electric element. It is used only to verify the functionality of the command and control system.

#### Burner (D):

This element will energize the Diesel Burner signal wire, which will then trigger the heat source to activate.

#### Three-Way Valve (E):

The final element on this screen is not directly related to the heating subsystems of the Aqua-Hot.

The three-way valve (sometimes known as the summer/winter valve) controls the flow of the antifreeze and water heating solution within the Aqua-Hot to deliver either hot water, or interior heat as requested.

Tapping on this element will change the valve's orientation. When this element displays "INT. HEAT" this valve is oriented to provide interior heat by circulating heating solution throughout the interior heating zone. When this element displays "HOT WATER" the valve is oriented such that heating solution is routed so that hot water can be provided.



# WARNING

**Heating sub-system testing is NOT a substitute for normal operation, and attempting to use it as such may result in catastrophic damage to the Aqua-Hot.**

### Controller Replacement Procedure:

1. If possible, tap the three lines icon at the bottom right corner of the LCD screen.
  - Tap the DIAGNOSTICS icon. Record all the information in the “Aqua-Hot Information Section”.
  - Tap and hold (for 3 seconds) within the information section.

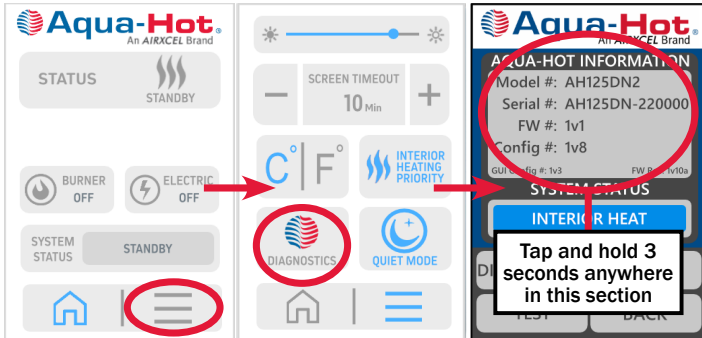

Figure 24

- Tap OPTIONS, CLIMATE ZONES, and take a picture of this screen.

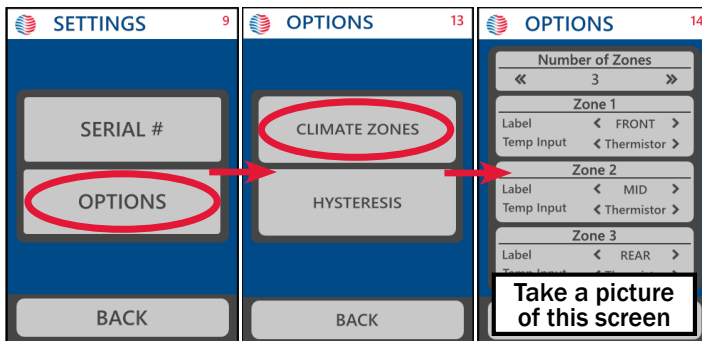

Figure 25

2. Disconnect all power to the Aqua-Hot.
3. Remove the four Philips screws attaching the top cover of the Aqua-Hot, and remove the top cover to gain access to the interior components.

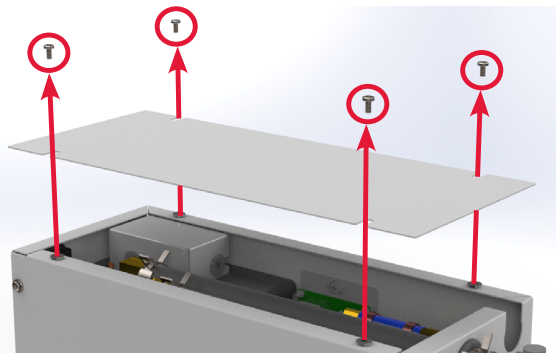

Figure 26

4. Using a 3/8” (10mm) socket, remove the hex nut from the top of the mounting plate (SAVE THE NUT TO USE AGAIN)

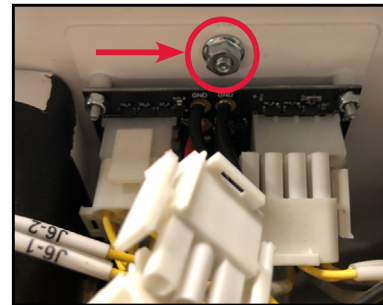

Figure 27

5. Gently lift up on the controller bracket and remove the plugs as they become accessible. The high-limit thermostat may need to be disconnected to provide clearance (a pair of needle-nose pliers is recommended to remove the connections).

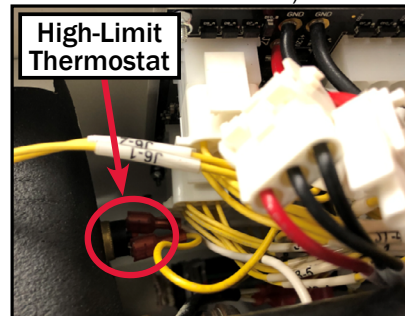

Figure 28

6. Disconnect the DC harness from the controller.
  - Suggested disconnect order (see Figure 29):
    - 3-Pin Molex power connector
    - 12-Pin Molex (top right of the controller)
    - 9-Pin Molex (top left of the controller)
    - RVC (middle right of the controller)
    - 15-Pin Molex (middle left of the controller)
    - 8-Pin Molex (bottom of the controller)

**NOTE: DO NOT DISCONNECT THE DC HARNESS FROM ANY OTHER ELECTRICAL CONNECTION IN THE UNIT.**

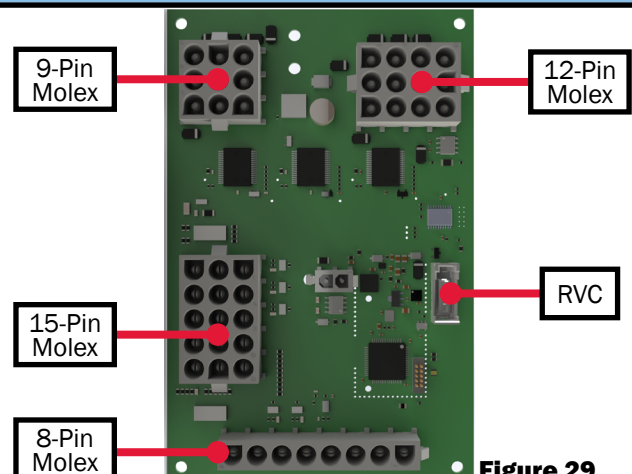
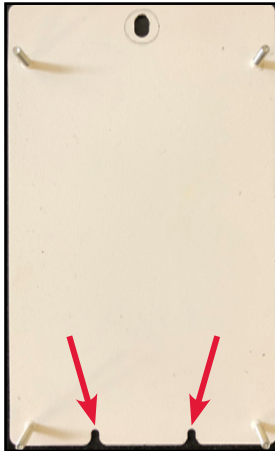

Figure 29

7. Lean the top of the mounting bracket out from the unit wall, and then slide the controller and mounting plate upwards and out of the unit.
  - The bottom of the mounting plate has two key-ways holding it in place (no nuts or other fasteners)



**Figure 30**

8. With the controller and mounting plate out of the unit, use a ¼" socket or nut driver to remove the four nuts attaching the controller to the bracket. The controller is supported by four small bushings - ensure that all four bushings remain on the bracket screws. Remove and discard the defective controller.

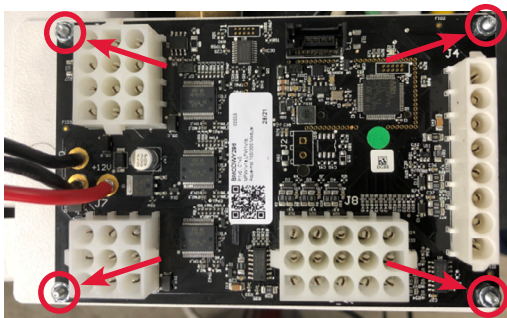

**Figure 31**

9. Plate new controller onto the mounting plate.
  - Ensure the controller is properly oriented - reference Figure 32.
10. Using the 4 nuts previously removed, fasten the controller to the mounting plate.
11. Insert the controller and mounting plate into the Aqua-Hot. As you insert the controller and mounting plate into the Aqua-Hot, the bottom of the mounting plate should slide along the wall with the top of the mounting plate leaned away from the wall to ensure the bottom catches the key-ways (Figure 30) while the top clears the mounting stud.
12. Lean the top of the controller and mounting plate back against the wall and ensure that the bottom of the mounting plate is seated on the key-ways.

13. Using the previously removed hex nut, fasten the mounting plate to the wall of the Aqua-Hot.

14. Carefully reinstall all of the plugs from the DC harness.
  - Ensure that both tabs for all Molex connectors click into place indicating a properly seated connection.
  - Ensure that the single tab for the RVC cable clicks into place indicating a properly seated connection.
  - Suggested order:
    - 8-Pin Molex (bottom of the controller)
    - 15-Pin Molex (middle left of the controller)
    - RVC (middle right of the controller)
    - 9-Pin Molex (top left of the controller)
    - 12-Pin Molex (top right of the controller)
    - 3-Pin Molex power connector

**NOTE:** All plugs have only ONE correct orientation. Do **NOT** force the plug into place.

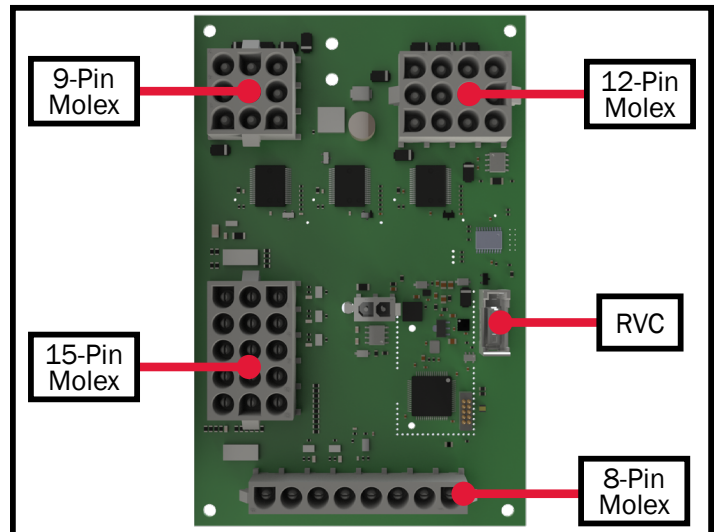

**Figure 32**

- Continue to the next section to set up the controller after installation is complete.

### Instructions for Controller Setup after Installation:

After replacement and installation of the controller, the system will need to be updated via the LCD Screen or RV Control panel.

Please follow the following steps to set up the heating system.

1. Provide power to the main harness of the Aqua-Hot. After the screen lights up, tap the three lines icon on the bottom right corner. Complete the following steps in order:
  - Tap the DIAGNOSTICS ICON
  - Tap and hold (for 3 seconds) within the “Aqua-Hot Information” section
  - Tap SERIAL NUMBER and follow the prompts on the screen

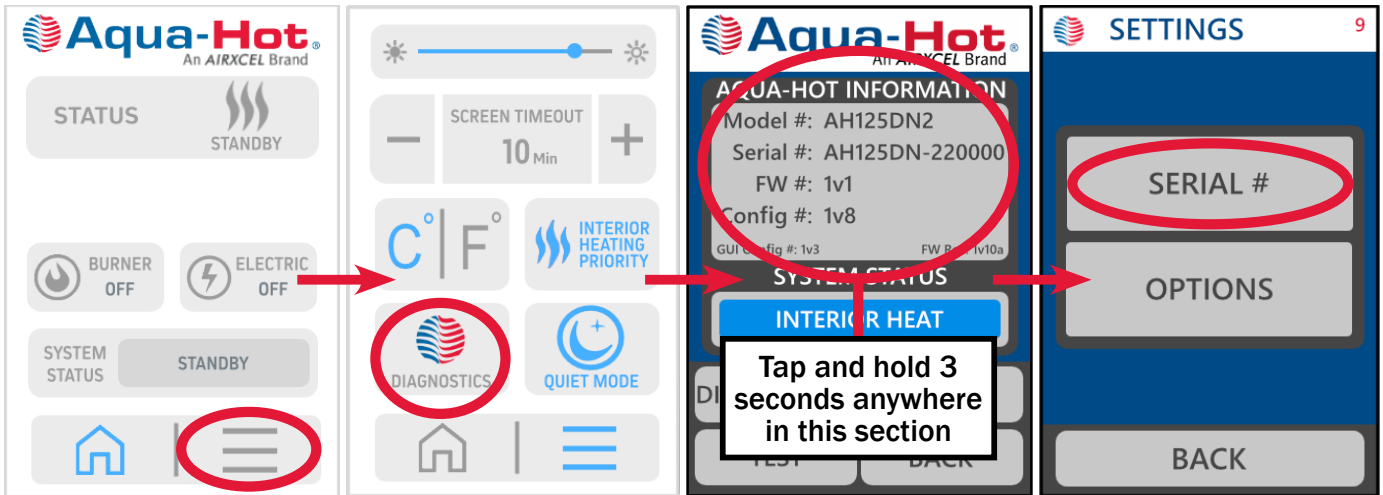

**Figure 33**

2. After completing Step 1, go back to the “Diagnostics” page, tap and hold (for 3 seconds) in the “Aqua-Hot Information” section.
  - Tap OPTIONS, CLIMATE ZONES, and then select the number of climate zones (A).
  - Choose a label and temperature input type for each zone (B).
  - Tap BACK until you’ve reached the “Home Screen”.

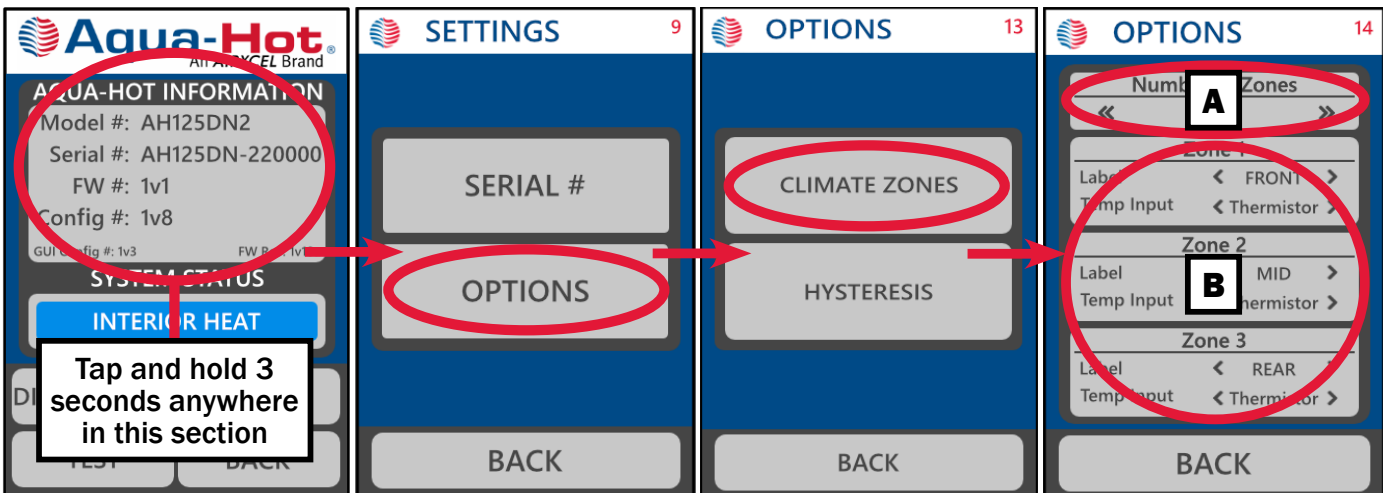

**Figure 34**

3. Test for normal operation.

## Fluid Level Sensor

### Introduction:

The fluid level sensor monitors the current fluid level within the Aqua-Hot. This device is intended as a fail-safe measure which will disengage the Aqua-Hot if the fluid ever drops below a set threshold. The fluid level sensor is located on the expansion bottle, which is either mounted to the side of the unit (see Figure 37), or within the RV.

If the fluid level sensor is malfunctioning, the Aqua-Hot will show no signs of operation whatsoever. Troubleshoot this sensor if there is an adequate amount of fluid present within the Aqua-Hot, and the unit does not operate.

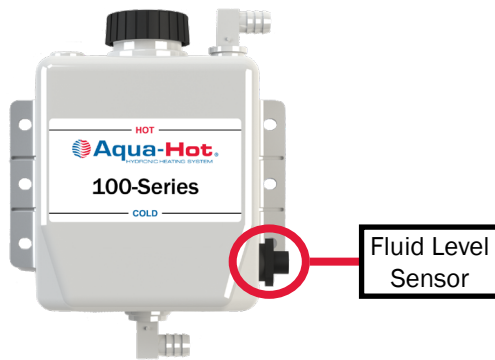

Figure 35

### Troubleshooting Guidelines:

Before troubleshooting the fluid level sensor, ensure that the following requirements have been met.

- The fluid expansion bottle is filled to at least the “COLD” mark.
- Verify that all RV-side in-line fuses are functional.
- Ensure that the unit is completely cool.
- Ensure that DC electrical power is supplied to the Aqua-Hot.
- Ensure that AC electrical power is supplied to the Aqua-Hot’s electric element.
- Ensure that the fluid level sensor is oriented correctly (see below).

If any of the requirements above are not fulfilled, correct them before continuing to diagnose the fluid level sensor. Reference the troubleshooting guide to the right.

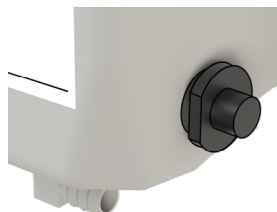
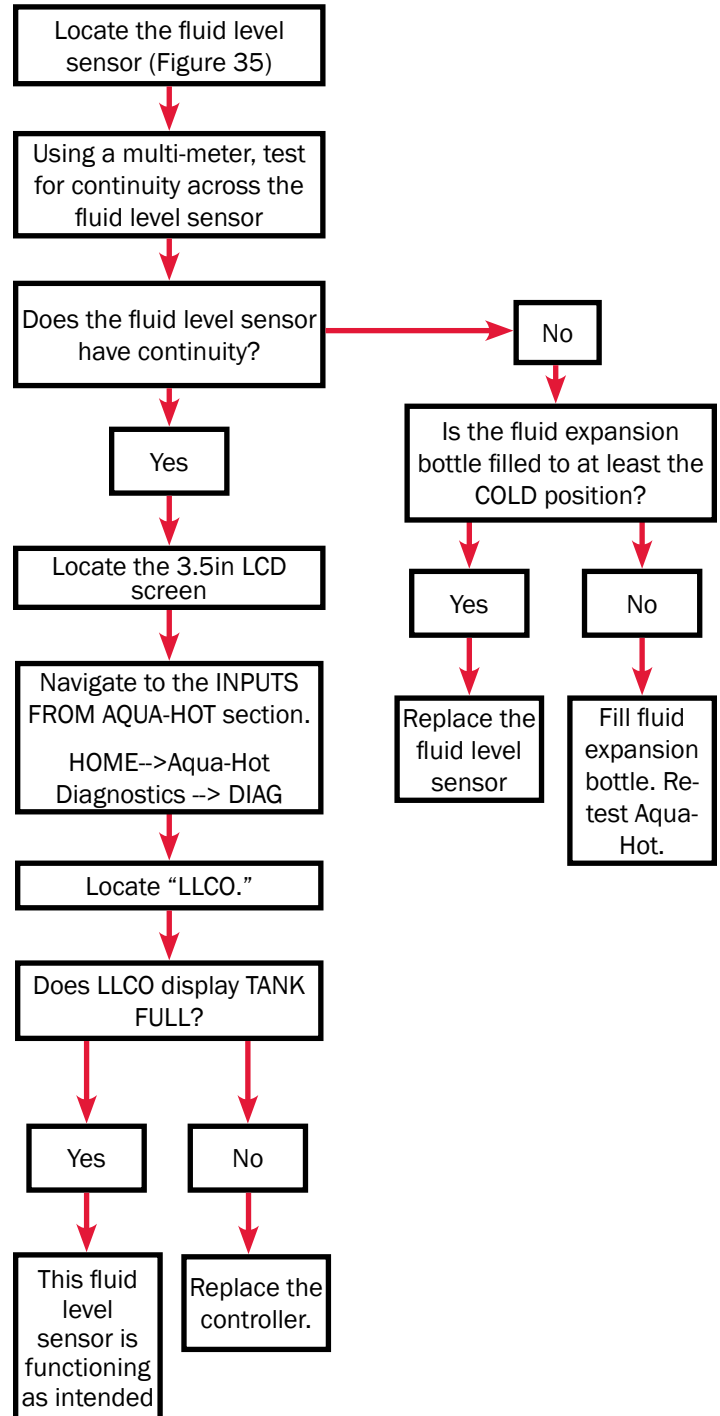

Figure 36

### Troubleshooting Procedure:





# WARNING

**Before continuing to the replacement procedure, ensure that the unit has cooled to ambient temperature, all power sources have been disconnected, and the unit is completely shut off.**

## Replacement Procedure:

In order to replace the fluid level sensor, the overflow bottle must also be replaced. Please visit [www.aquahot.com](http://www.aquahot.com) or call (800) 685-4298 to order the expansion bottle kit. Once you have the replacement part in hand, follow the procedure below.

1. Locate the fluid expansion bottle.
2. Clamp the overflow hose as close to the bottom fitting as possible.
3. Grab a bucket or drain receptacle and place it directly under the lower fitting of the expansion bottle.
4. Remove the clamp from the lower fitting of the expansion bottle.
5. Remove the hose and allow the excess fluid to drain into the bucket.
6. Remove the overflow hose from the upper fitting of the expansion bottle.
7. Remove the old expansion bottle, disconnect the Faston connectors, and discard the old bottle.
8. Secure the new bottle in position.
9. Crimp the new faston connectors to the new fluid level sensor.
10. Connect these wires to their receptacles on the Aqua-Hot harness.
11. Reconnect the overflow hose to the upper fitting.
12. Reconnect the expansion hose to the lower fitting.
13. Fill the bottle with the previously drained fluid.
14. Remove the hose clamps.
15. Test the Aqua-Hot for normal functionality.

If additional assistance is required please contact the Aqua-Hot Heating Systems Technical support department at (800) 685-4298 from 7:00am to 4:00pm MST Monday through Friday.

Expansion Bottle can either be found mounted to the side of the Aqua-Hot unit or within the RV.

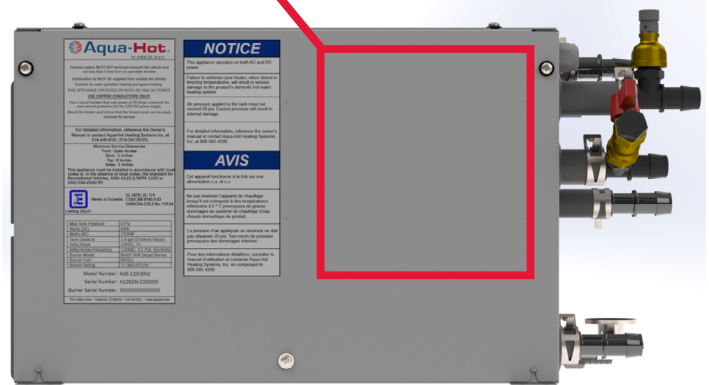

**Figure 37**

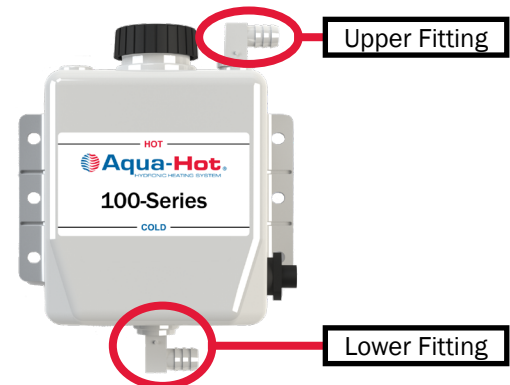
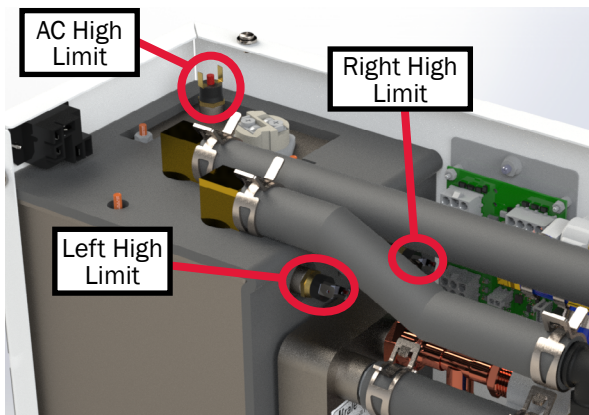

**Figure 38**

## High-Limit Thermostats

### Introduction:

The Aqua-Hot is equipped with three resettable High-Limit Thermostats. These thermostats are in place to prevent the heater from operating beyond its safe operational threshold. These thermostats are resettable and easily replaceable.



**Figure 39**

Begin troubleshooting the High-Limit Thermostats if the controller issues an overheat fault, or the electric and/or diesel burner fail to operate correctly.

### Troubleshooting Guidelines:

The following conditions must be met before the High-Limit Thermostats can be diagnosed, and if necessary, repaired.

- The fluid expansion bottle is filled to at least the “COLD” mark.
- Verify that all in-line fuses are functional.
- Ensure that the unit is completely cool.
- Ensure that DC electrical power is supplied to the Aqua-Hot.
- Ensure that AC electrical power is supplied to the Aqua-Hot’s electric element.

If any of the above conditions are not met, correct them before continuing with troubleshooting. Results of the troubleshooting procedure cannot be verified if the conditions listed above are not fulfilled.

### Troubleshooting Procedure:

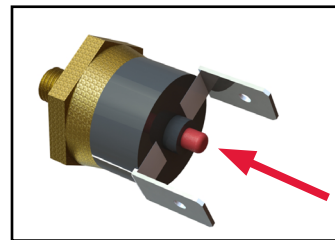
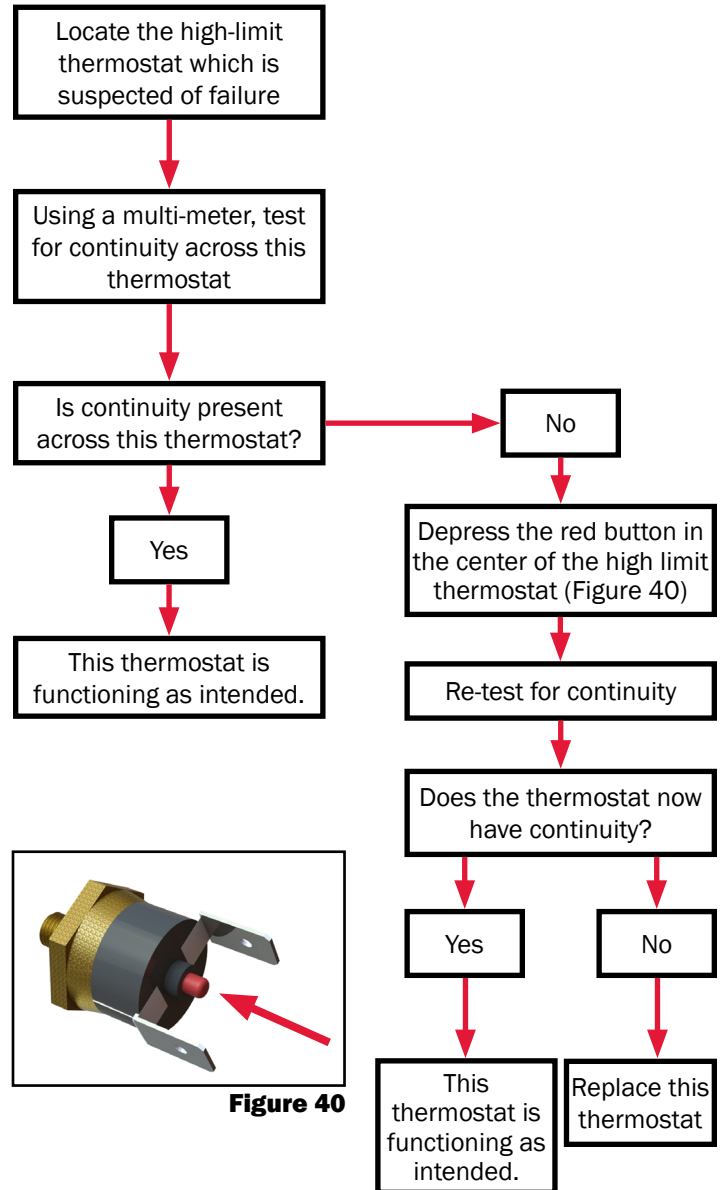

**Figure 40**

## Replacement Procedure:

If it has been determined that one, or multiple high-limit thermostats need to be replaced, they can be easily replaced by following the directions below.

1. Disconnect all sources of AC and DC power from the Aqua-Hot (if the AC high-limit thermostat is the issue, the AC access cover will need to be removed - see Figure 41).
2. Disconnect the wires which connect to the non-functional high-limit thermostat.
3. Using a  $\frac{5}{8}$ " (16mm) wrench, remove the thermostat from its location on the fluid tank.
4. Locate the new thermostat and secure it in place of the old thermostat.
5. Reconnect the disconnected wires as described by the table below.

High Limit Thermostat	Wires
Left	J6-3 and BOT1
Right	BOT1 and J6-3-HL
AC	AOT1 and AOT2

6. Test the Aqua-Hot for normal operation.

If issues persist, please contact Aqua-Hot Heating Systems for additional assistance.

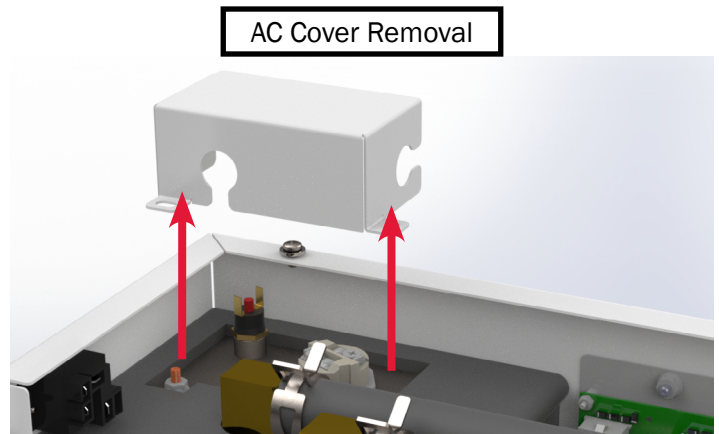

**Figure 41**

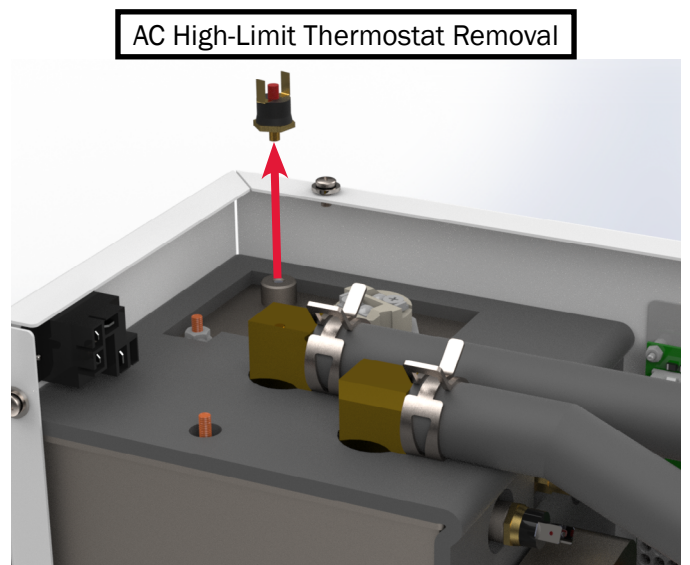

**Figure 42**

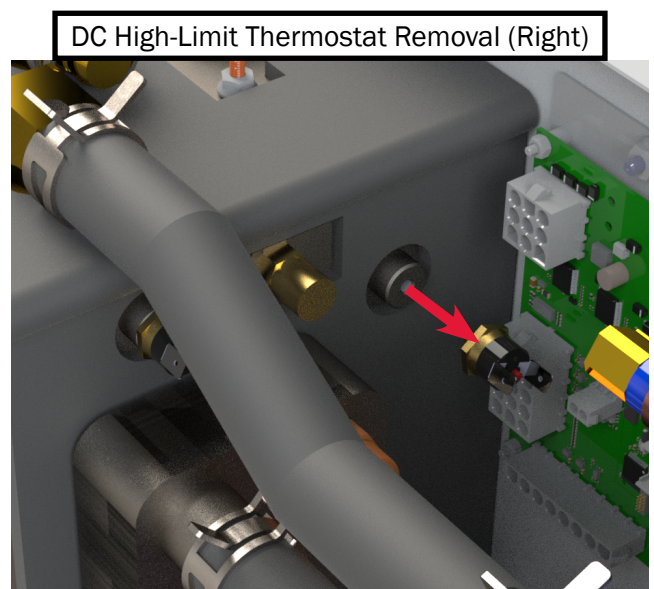

**Figure 43**



## Low-Temperature Cutoff Thermostat

### Introduction:

The Low-Temperature Cutoff Thermostat (LTCO) is installed to measure the incoming domestic water temperature. Using that reading, the Aqua-Hot controller is able to determine whether a demand for hot water exists or not.

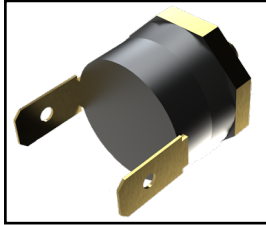

Figure 44

This thermostat should be diagnosed if there is a lack of interior heat or hot water and the tank is up to operating temperature. Follow the directions below to diagnose, and if necessary, replace the Low-Temperature Cutoff Thermostat.

### Troubleshooting Procedure:

Use the following troubleshooting tree to diagnose the Low-Temperature Cutoff Thermostat.

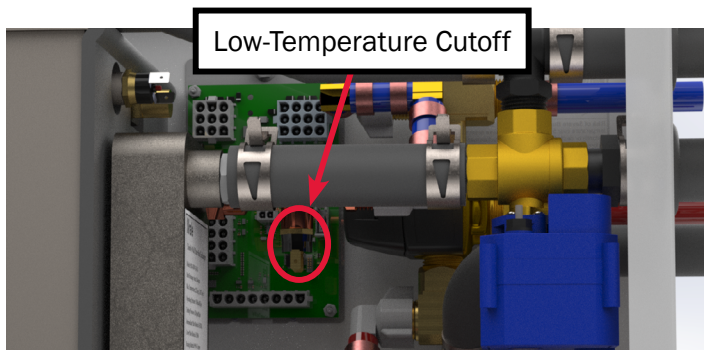
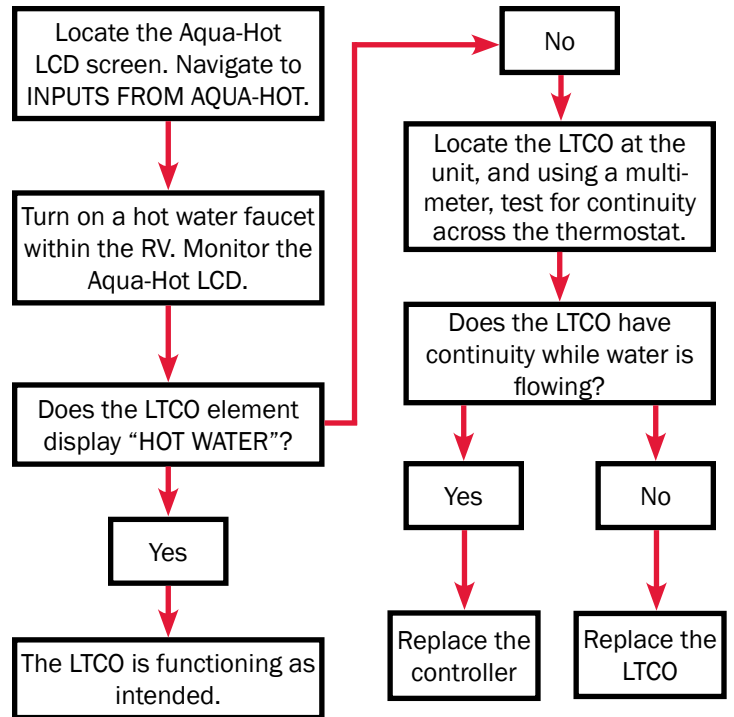

Figure 45

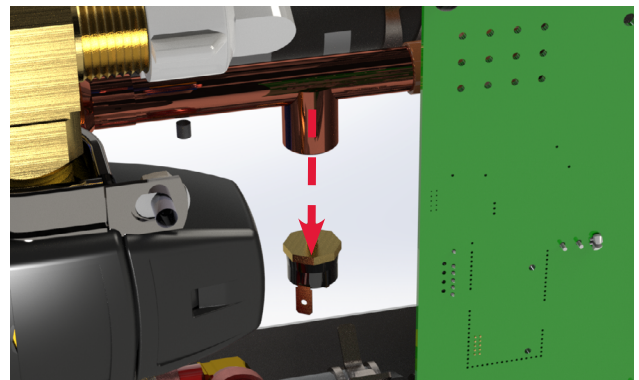

Figure 47

**NOTE:** The side panel has been made transparent in the view above to aid in the explanation of the repair. DO NOT remove this side panel. Doing so risks irreparable damage to the Aqua-Hot.

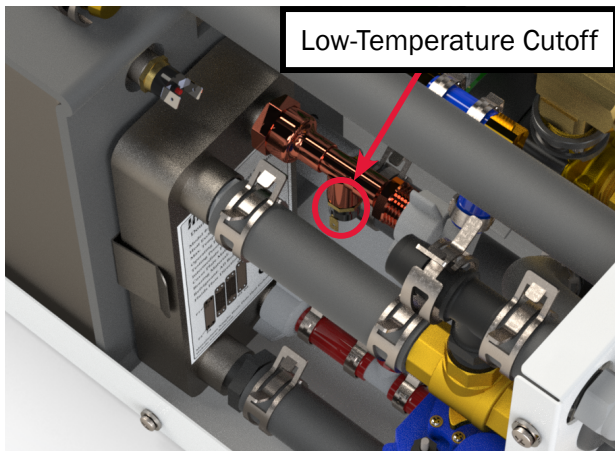

Figure 46

### Replacing the Low-Temperature Cutoff Thermostat:

1. Disconnect all sources of AC and DC power from the Aqua-Hot
2. Disconnect the wires from the LTCO.
3. Remove and discard the defunct LTCO thermostat using a 5/8" wrench.
4. Position and secure the new LTCO thermostat into place.
5. Connect wires J4-1 and J4-2 to the new LTCO thermostat.

## Three-Way Valve

### Introduction:

The three-way valve (aka the summer/winter valve) is responsible for changing the flow of coolant either through the interior heating zone (int heat) or circulating coolant within the boiler tank (stir mode) to produce hot water.

If the three-way valve has failed, it can lead to a loss of interior heat and/or hot water. Follow the steps below to troubleshoot the three-way valve.

### Troubleshooting Procedure:

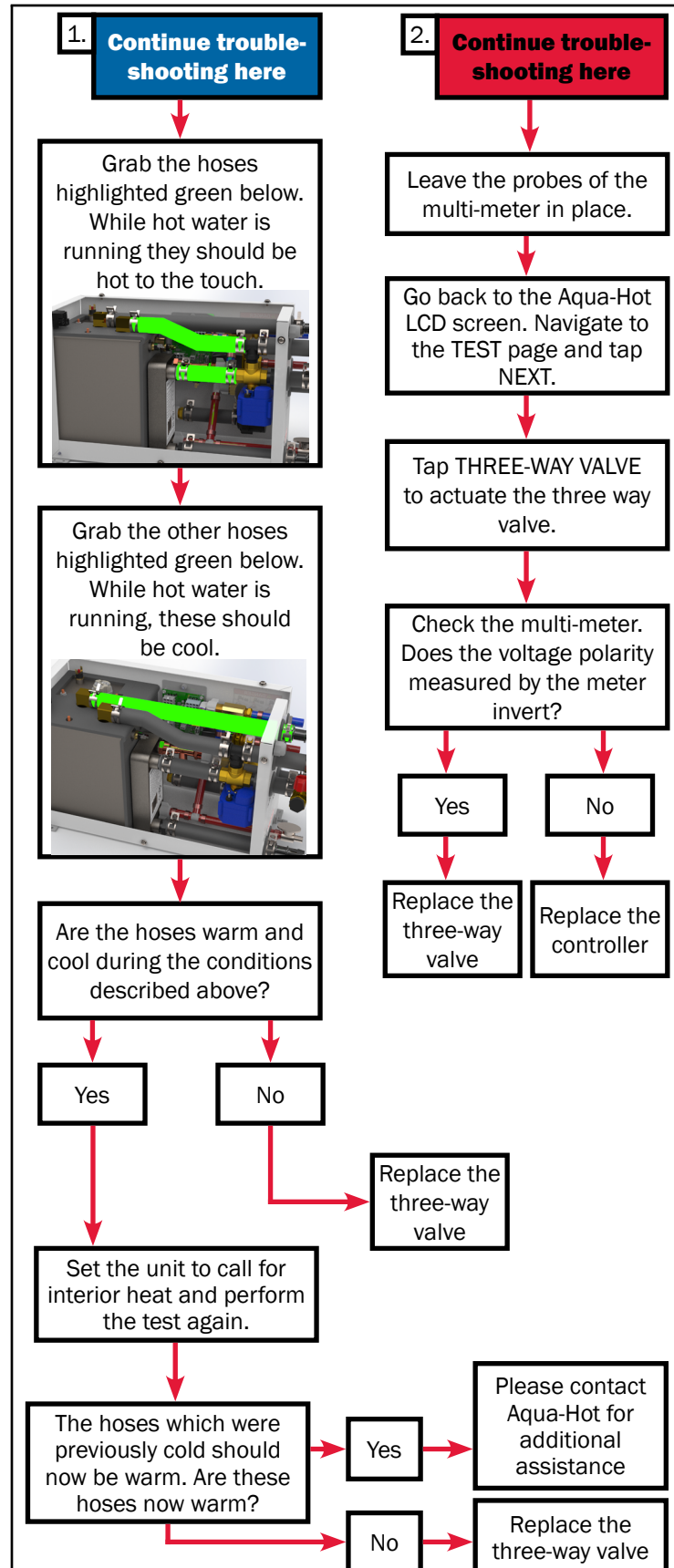
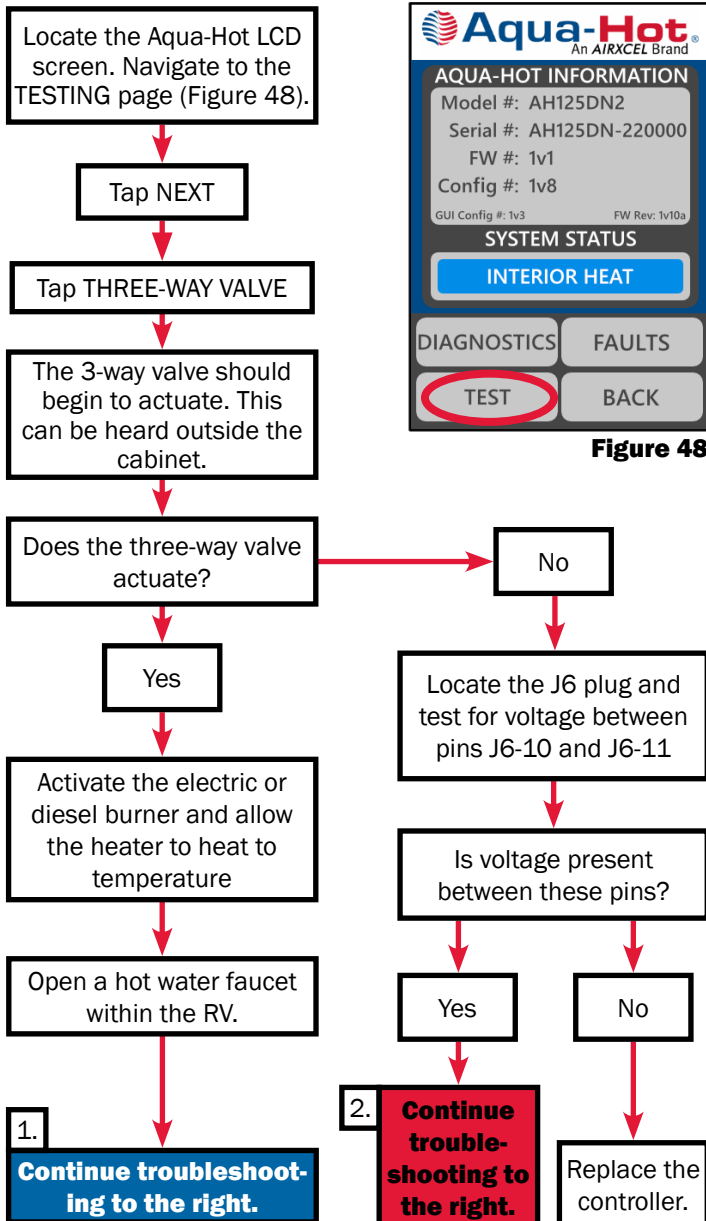

## NOTICE

**DO NOT remove the rivets securing the side panel into place. Attempting to do so risks irreparable damage to the boiler tank of the Aqua-Hot**

Before replacing the 3-way valve, you must purchase the repair kit. The Repair Kit should include:

- Three-Way Valve
- Black Nylon tee adapter
- Black Nylon barb adapter
- 2-Pin electrical connector

### Replacement Procedure:

1. Drain coolant from system.
  - Pour into a bucket to be reused later.
2. Remove top and side panels from the Aqua-Hot.
  - Save screws and washers to reuse later
3. Locate the Three-Way Valve in the Aqua-Hot.

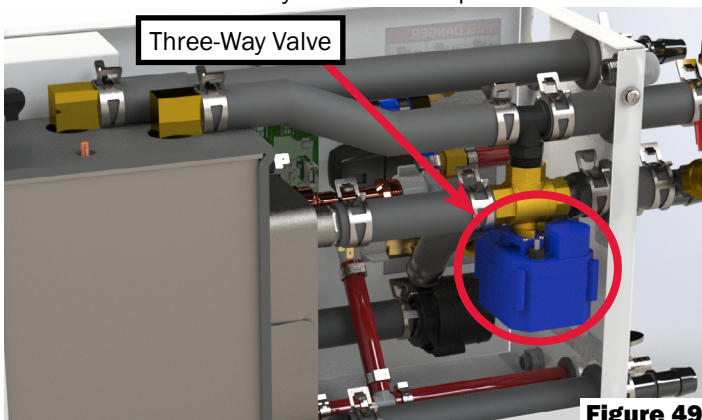

**Figure 49**

4. Disconnect the electrical connection from the Three-Way Valve to the DC harness.
5. On the right side of the Three-Way Valve, move the constant tension clamp onto the brass of the Three-Way Valve to ensure it is out of the way.
6. On the top of the Three-Way Valve, move the two (2) constant tension clamps AWAY from the tee fitting so that they are as far from the barb as possible.
7. On the left of the Three-Way Valve, unscrew the brass PEX fitting from the Three-Way Valve using a wrench.
  - There may be residual fluid that exits the fittings - use towels or other clean up items as necessary.
8. Remove 3/4" heater hose from the tee on the top of the Three-Way Valve.

- There may be residual fluid that exits the fittings - use towels or other clean up items as necessary.
9. Carefully remove the Three-Way Valve from the last 3/4" heater hose on the right of the valve.
    - There may be residual fluid that exits the fittings - use towels or other clean up items as necessary.
  10. Remove constant tension clamp from the brass of the Three-Way Valve on the right, and place it on the new Three-Way Valve in the same position on the brass.
  11. Discard the old valve and fittings.
  12. Using a nylon wire brush, clean the threads of the PEX fitting so that it is free of leftover thread sealant.
  13. Carefully insert the single barb back into the heater hose that the old valve was attached to.
  14. Add thread sealant (454 Loctite or better) to the threads of the PEX fitting.
  15. Using a wrench, thread the PEX fitting into the three-way valve.
    - 3-6 rotations
    - DO NOT BRACE ON THE BLUE PLASTIC WHEN TIGHTENING. This may damage the mechanism or electrical components.
  16. Install the hoses on the tee on the top of the valve.
  17. Move the constant tension hose clamps to just behind the barb of each fitting.
    - Left side of the tee on the top of the 3-way valve.
    - Right side of the tee on the top of the 3-way valve.
    - Right side of the 3-way valve, off the brass onto the hose.
  18. Connect the electrical wire from the valve to the DC harness.
  19. Reinstall the side panel and lid using the saved screws and washers from Step 2.
  20. Refill the unit with the coolant saved from Step 1.
    - Add more coolant is needed.
    - Monitor the newly installed parts and fittings for leaks.

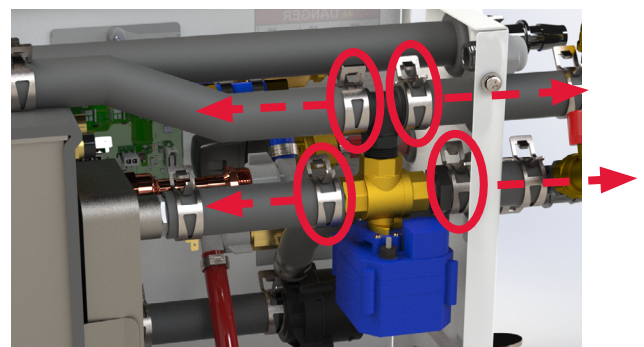
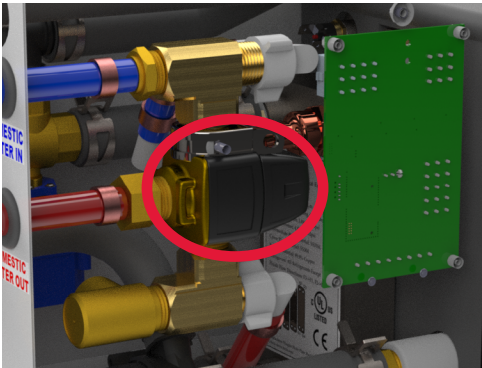

**Figure 50**

## Tempering Valve

### Introduction:

The tempering valve of the Aqua-Hot mixes the hot domestic water from the interior of the Aqua-Hot with cold incoming domestic water to temper it to a threshold where scalding will not occur.



**Figure 51**

**NOTE:** The side panel has been made transparent in the view above to aid in the explanation of the repair. **DO NOT** remove the side panel - only remove the service panels. Doing so risks irreparable damage to the Aqua-Hot.

**⚠ DANGER**

**Risk of Severe Burn or Death from Scalds.** Water temperature over 51°C (123.8°F) can cause severe burns instantly or death from scalds. See instruction manual before setting temperature at water heater. Feel water before bathing or showering. Temperature limiting valves are available, see manual.

**WARNING:**  
HOT WATER CAN PRODUCE 3RD DEGREE BURNS  
- IN 6s at 60°C (140°F)  
- IN 30s at 54°C (129.2°F)  
WATER DELIVERY TEMPERATURE MIXING VALVE WAS FACTORY SET AT 49°C (120.2°F).  
CONTACT QUALIFIED SERVICE PERSONNEL FOR ADJUSTMENTS.

**Risque de brûlures graves ou la mort de brûlures.** De l'eau à une température au-dessus de 51 °C (123,8 °F) peut ébouillanter et causer instantanément des brûlures graves allant jusqu'à la mort. Consultez le manuel d'instructions avant de régler la température du chauffe-eau. Vérifiez la température de l'eau avant de prendre un bain ou une douche. Des soupapes de limite de température sont disponibles, voir le manuel.

**AVERTISSEMENT:**  
L'EAU CHAUDE PEUT PRODUIRE DES BRÛLURES DE TROISIÈME DEGRÉ  
- EN 6s à 60°C (140°F)  
- EN 30s à 54°C (129.2°F)  
LA VANNE DE MÉLANGE DE TEMPÉRATURE D'ALIMENTATION EN EAU A ÉTÉ RÉGLÉE EN USINE À 49 °C (120.2 °F).  
CONTACTER DU PERSONNEL DE SERVICE QUALIFIÉ POUR LES ADJUSTEMENTS.

LDE-003-260

### Testing Procedure:

Follow the testing procedure to the right in order to diagnose the tempering valve. Troubleshoot the tempering valve if the following conditions have occurred:

- A lack of hot water.
- Hot water supply is uneven.
- Hot water is too hot.

Activate the Aqua-Hot's diesel burner to provide as much heat as possible to the boiler tank. This test cannot be completed with only the electric element.

Open the shower head valve within the RV to its hottest setting.

Place one hand on the red PEX tubing, and before the tempering valve and outside the Aqua-Hot.

Are both the red PEX and just before the tempering valve warm while hot water is running?

Yes

No

This tempering valve is functioning as intended.

Replace the tempering valve.

**NOTE:** Adjusting the mixing valve beyond 120°F (49°C) will result in a lack of hot water and may result in scalding. Do NOT attempt to adjust the tempering valve without assistance from Aqua-Hot Technical Support or a qualified Aqua-Hot technician.

**NOTE:** The Aqua-Hot Domestic Water System is rated for a water flow of 0.8 GPM. It is not recommended to modify the water flow. This can cause an over-pressurized system or lack of consistent hot water.

## Replacement Procedure:

1. Shut off the external domestic water connection, and open a hot water faucet valve within the RV to relieve the water pressure.
2. Open the domestic water drain valve on the Aqua-Hot and release water in the system.
  - Attach hose to the ½" PEX barb to release fluid without spilling throughout the RV
  - Ensure that the hose does not rise from the drain valve otherwise proper drainage will not happen.
3. Disconnect the RV side domestic water connections
4. Remove the top cover and side covers of the Aqua-Hot to gain access to the interior components.
  - Save the screws and washers to be reused later.
5. Using a ⅜" (10mm) socket, remove the nut which secures the domestic water valve assembly to the side of the Aqua-Hot cabinet (shown below).

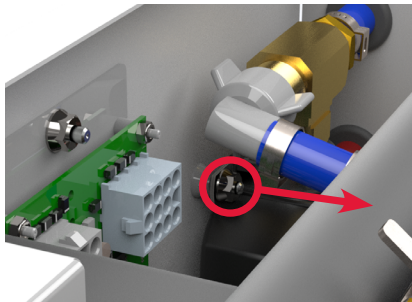

**Figure 52**

6. Disconnect the swivel fittings attached to the brass tees on the tempering valve.
  - One swivel fitting is attached to the red PEX and the other is attached to the blue PEX.
  - There may be residual fluid in the lines. Use clean-up items and tools as needed.

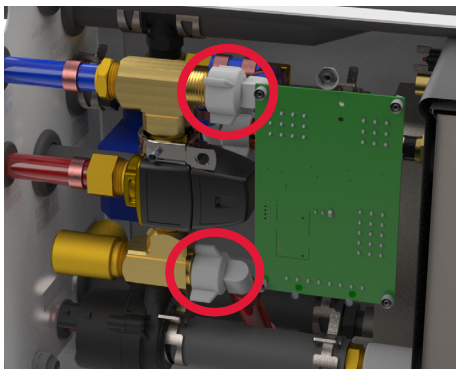

**Figure 53**

**NOTE:** The side panel has been made transparent in the view above to aid in the explanation of the repair. DO NOT remove the side panels. Doing so risks irreparable damage to the Aqua-Hot.

7. Remove the P-clamp from the stud on the wall of the Aqua-Hot. Save the P-clamp for reuse later.
8. Slide the tempering valve assembly gently backwards towards the coolant tank until the PEX tubes of the assembly are no longer protruding from the Aqua-Hot.
  - Ensure you do not collide with the controller or damage any other components in the Aqua-Hot.
9. Remove the assembly from the Aqua-Hot.
10. Remove all three fittings from the tempering valve as shown below.

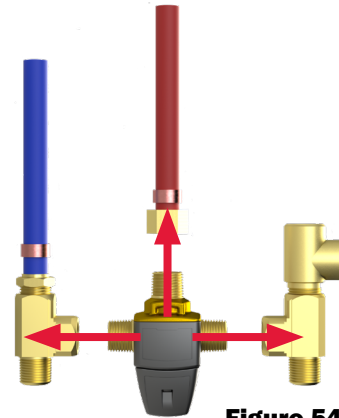

**Figure 54**

11. Discard the defunct mixing valve.
12. Using Teflon tape and domestic water safe thread sealant, reinstall all fittings to previous orientations.
13. Place previous P-clamp onto the assembly before inserting into the Aqua-Hot.
14. Insert repaired assembly into the Aqua-Hot and slide the red and blue PEX through their ports in the front face of the Aqua-Hot.
  - Use soapy water as necessary to lubricate the PEX going through the rubber grommets in the ports.
  - DO NOT SPRAY ELECTRICAL COMPONENTS AND WIRES WITH SOAPY WATER.
15. Connect the swivel fittings back to their respective places on the assembly.
  - Do NOT over-tighten the swivel fittings.
16. Using the nut from Step 5, tighten down the P-clamp on the assembly.
17. Reattach the domestic water lines and check for leaks before replacing the side and top panels of the Aqua-Hot.
18. After checking for leaks, replace the side and top panels of the Aqua-Hot using the screws from Step 4.

## Fluid Circulation Pump

### Introduction:

The fluid circulation pump operates to provide fluid circulation to either the interior heating zone or the antifreeze boiler tank depending on the heating and hot water needs at the time.



Figure 55

### Troubleshooting Procedure:

If the fluid circulation pump has failed, it will typically indicate an over-current fault on the controller fault log. If this is the case, the fault must be verified before replacing the circulation pump. Follow the procedure to diagnose the fluid circulation pump.

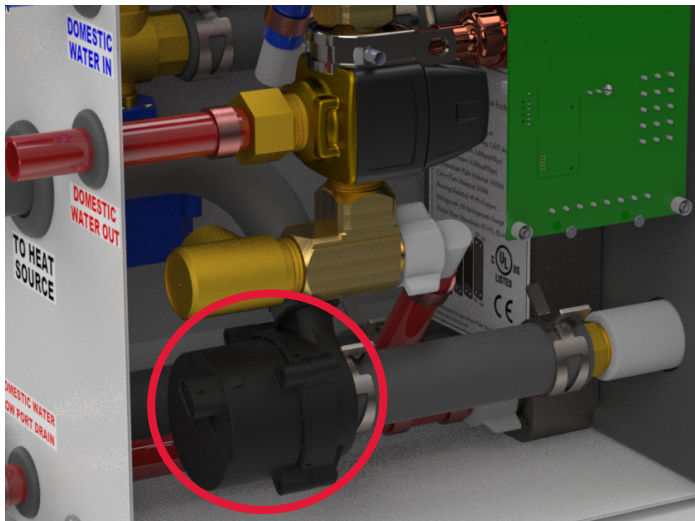
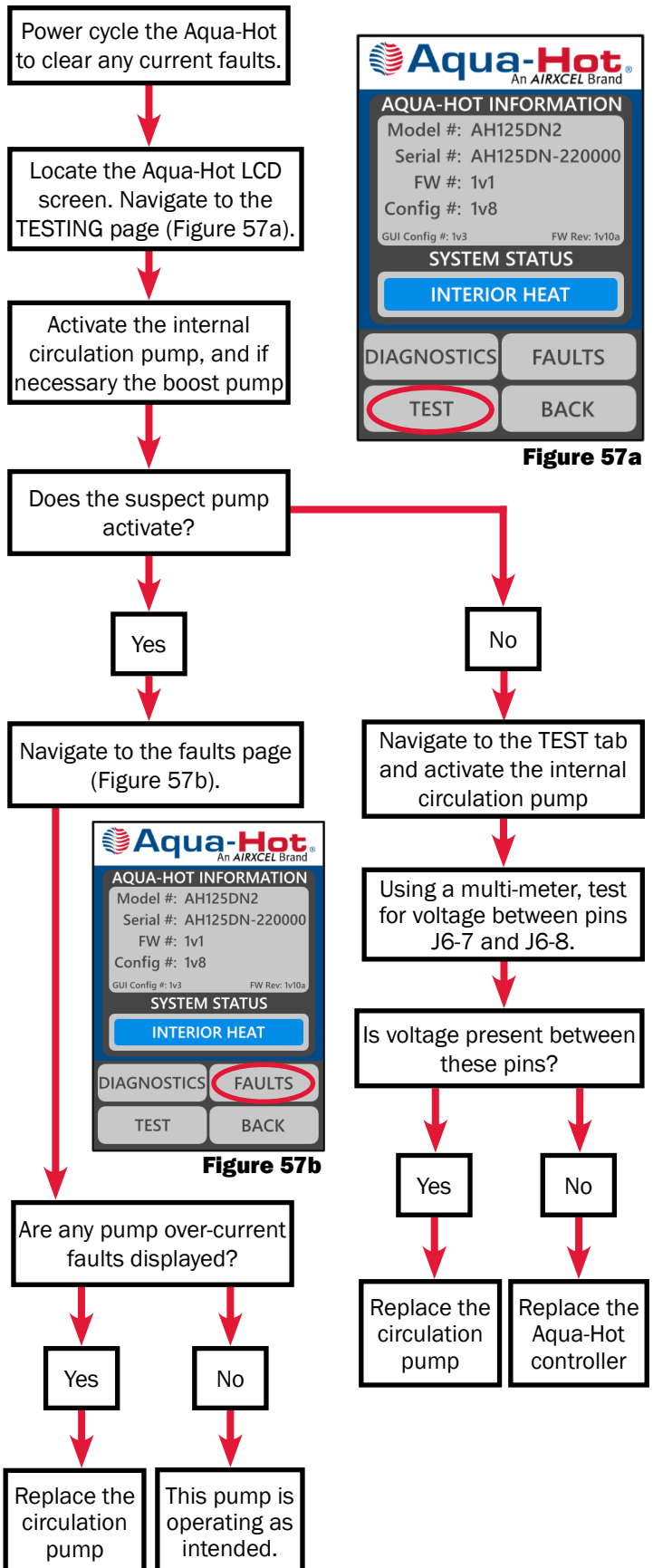

Figure 56

**NOTE:** The side panel has been made transparent in the view above to aid in the explanation of the repair. DO NOT remove the side panels. Doing so risks irreparable damage to the Aqua-Hot.



## Replacement Procedure:

1. Drain coolant from system. Pour into a bucket to be reused later.
2. Remove the top and side panels from the Aqua-Hot. Save the screws and washers to be reused later.
3. Place a paper towel into the Aqua-Hot unit on the bottom of the cabinet. (This is to help absorb any residual coolant left in the lines upon pump removal.)
4. Remove electrical plug to the circulation pump and move up and out of the way.
5. Remove both hose clamps from the barbs of the pump.
  - Leave the clamps on the 90° hose and hose from the tank - to be reused later - see Figure 58.
6. Carefully remove the 90° hose from the pump.
7. Carefully remove the pump from the hose attached to the tank.
8. Remove the pump from the Aqua-Hot and discard it.
9. Insert the new circulation pump into the Aqua-Hot and attach it to the hose coming from the tank.
10. Attach the 90° hose to the circulation pump barb.
11. Move both hose clamps onto the barbs of the new circulation pump.
12. Plug the connection from Step 4 into the circulation pump.
13. Reinstall the side and top panels using the saved screws and washers from Step 2.
14. Refill the unit with the coolant saved in Step 1.
  - Add more coolant if needed.
  - Monitor the newly installed parts and fittings for leaks.

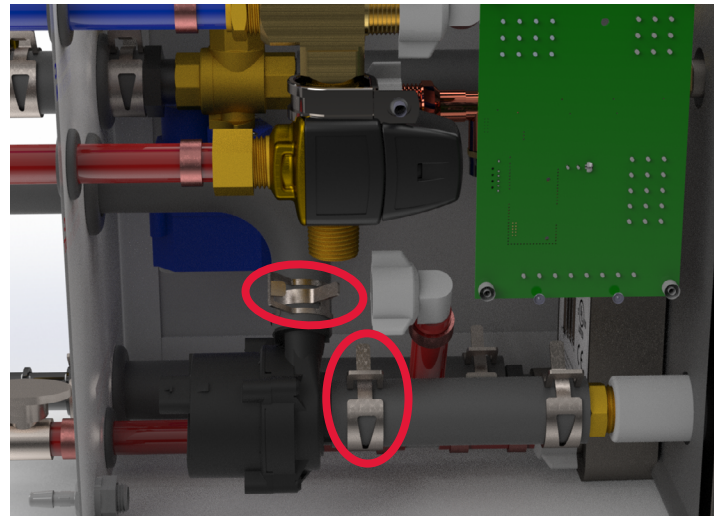

**Figure 58**

**NOTE:** The side panel has been made transparent in the view above and below to aid in the explanation of the repair. DO NOT remove the side panels. Doing so risks irreparable damage to the Aqua-Hot.

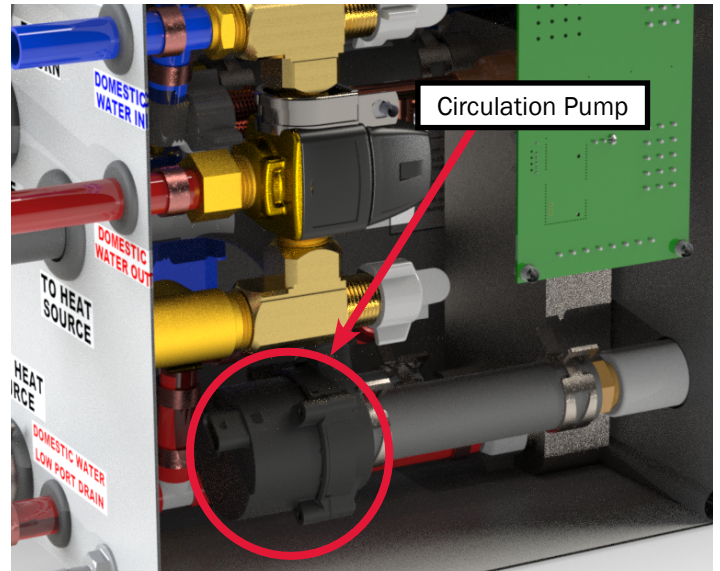

**Figure 59**

## AC Electric System

### Introduction:

The AC Electric system of the Aqua-Hot 125-DN2 unit functions to provide heat to the Aqua-Hot boiler tank. This is done with an electric element and an electric relay.

### Troubleshooting Procedure:

Troubleshoot the AC Electric system if the electric element is not functioning properly.

The following conditions must be met before the AC Electric system can be diagnosed, and if necessary, repaired.

- The fluid expansion bottle is filled to at least the “COLD” mark.
- Verify that all in-line fuses are functional.
- Ensure that the unit is completely cool.
- Ensure that DC electrical power is supplied to the Aqua-Hot.
- Ensure that AC electrical power is supplied to the element.
- Verify the thermostats are in working order.
- Verify there are no faults on the Aqua-Hot LCD.

If any of the above conditions are not met, correct them before continuing with troubleshooting. Results of the troubleshooting procedure cannot be verified if the conditions listed above are not fulfilled.

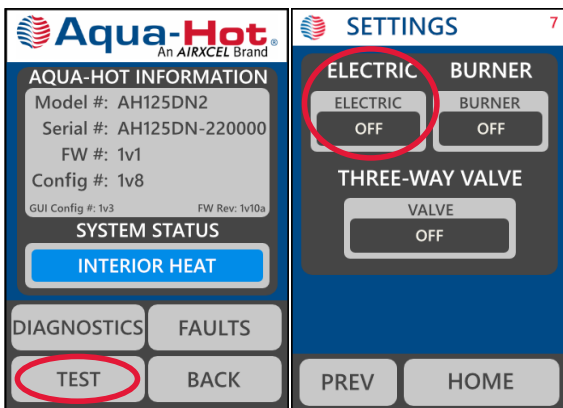

Figure 60

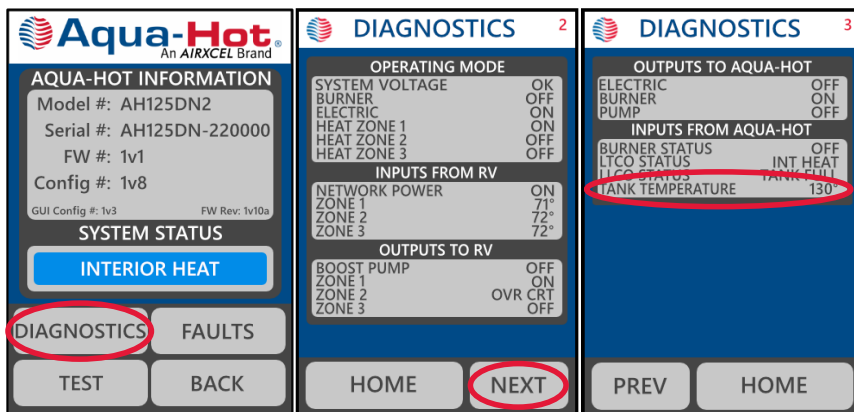
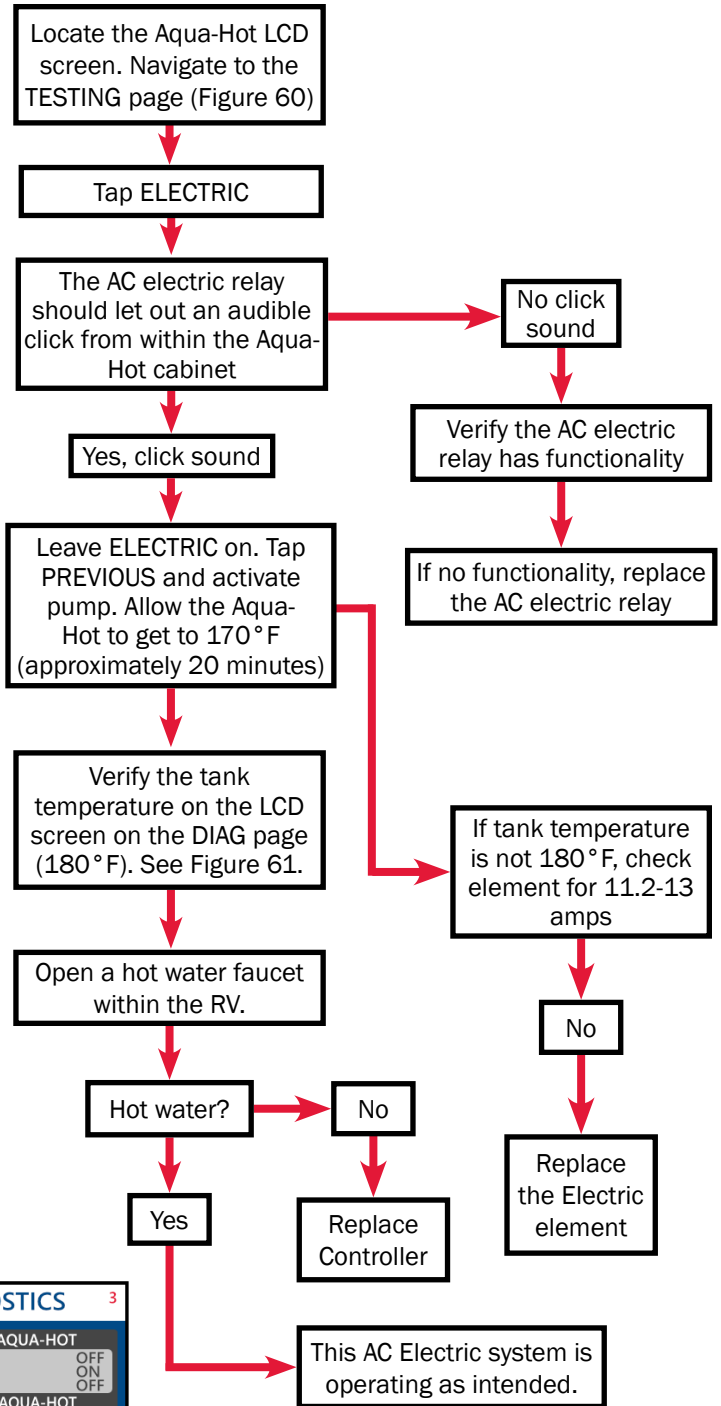

Figure 61





### Replacement Procedure:

1. Ensure that the Aqua-Hot has been completely shut down and all power sources have been disconnected. Be sure the boiler tank is completely cooled.
2. Using hose pinch-off pliers, clamp off the heating zone inlet and outlet ports.
3. Drain the antifreeze and water solution from the Aqua-Hot's boiler tank from the TO HEAT SOURCE and FROM HEAT SOURCE hoses, turning the unit so that the front is down. Drain the coolant into an external container to be reused.
4. Remove the AC access panel on the Aqua-Hot (Figure 63 & Figure 64).
5. Remove the two wires secured to the defective electric heating element by releasing the screw terminals (Figure 65).
6. Using a 1-1/2" (38mm) socket, remove the defective heating element from the Aqua-Hot's boiler tank.
7. Use a healthy amount of Loctite 454 on the threads of the new electric element to ensure that it forms an adequate seal.
8. Install the replacement 1500W electric element into the boiler tank and secure it with the 1-1/2" (38mm) socket.
9. Reconnect the wires previously disconnected from the electric heating element and tighten the screw terminals, then put the AC cover back on.
10. Refill the Aqua-Hot boiler tank with the previously drained fluid, add more 50/50 mix of ethylene glycol and distilled water to the tank if needed.
11. If necessary, purge the heat exchanger lines to remove any and all air from the system by running the fluid circulation pump for 20 minutes.

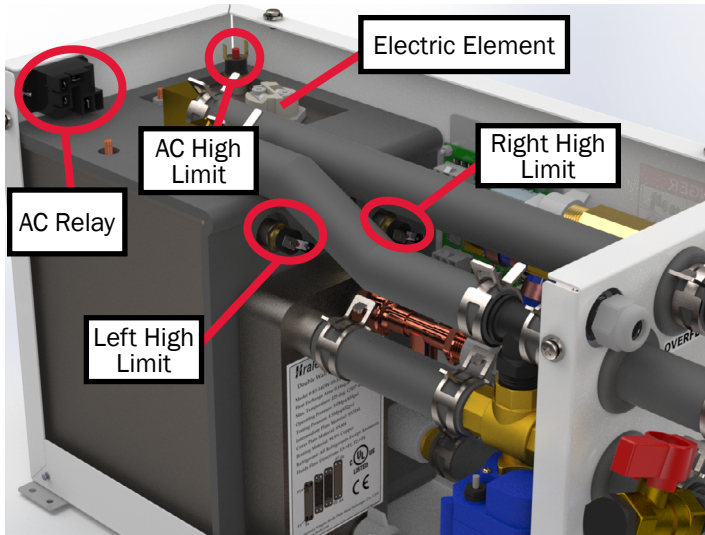

Figure 62

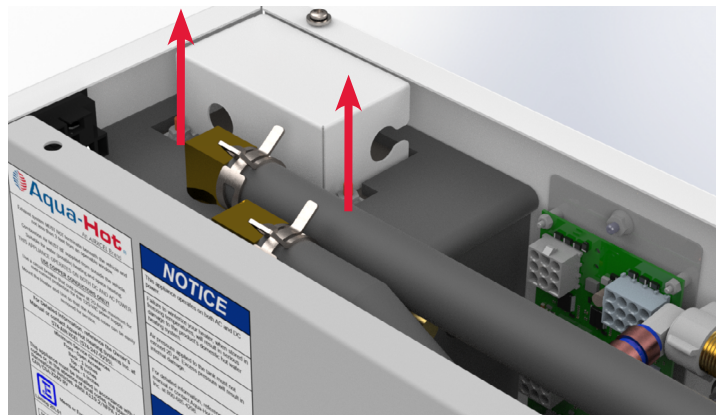

Figure 63

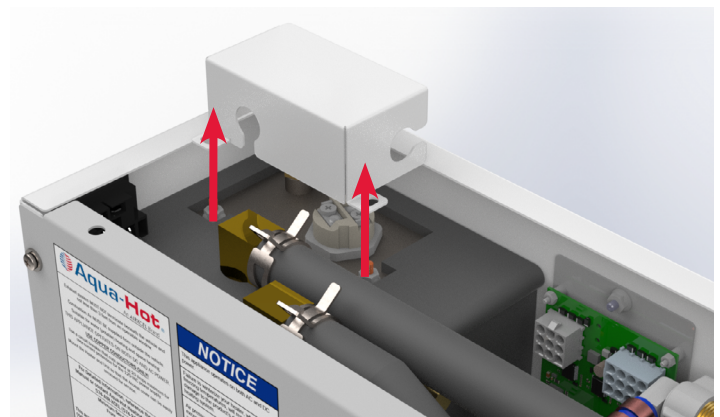

Figure 64

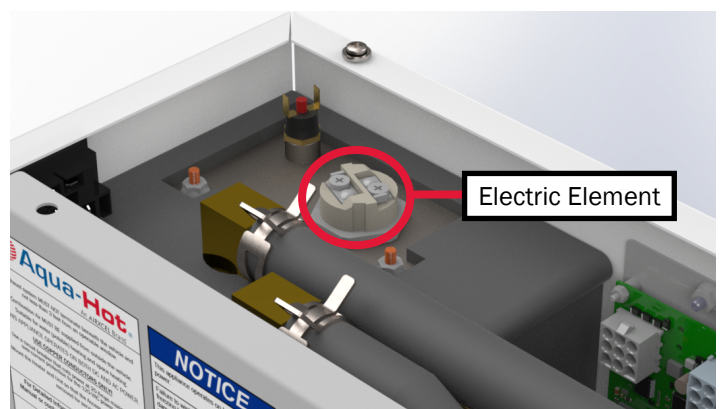

Figure 65

## AC Relay

### Introduction:

The AC Relay is an electrical device where the DC circuit from the controller determines whether the AC power is permitted to flow to the electric heating element. This allows the controller to switch the electric heating element on and off in conjunction with the interior switch panel and ETS module even though the electric element is on a separate circuit.

### Troubleshooting Procedure:

Troubleshoot the AC Relay if the electric element fails to operate. This can be verified with a simple test outlined below.

The following conditions must be met before the AC Relay can be diagnosed, and if necessary, repaired.

- The fluid expansion bottle is filled to at least the “COLD” mark.
- Verify that all in-line fuses are functional.
- Ensure that the unit is completely cool.
- Ensure that DC electrical power is supplied to the Aqua-Hot.
- Ensure that AC electrical power is supplied to the Aqua-Hot’s electric element.
- Verify the thermostats are in working order.

If any of the above conditions are not met, correct them before continuing with troubleshooting. Results of the troubleshooting procedure cannot be verified if the conditions listed above are not fulfilled.

1. Locate the AC wires connected to the AC Relay and remove the wires from the relay.
2. Using an ohmmeter, check the AC relay pins for continuity.
3. If no continuity exists, follow the procedure to replace the AC Relay.

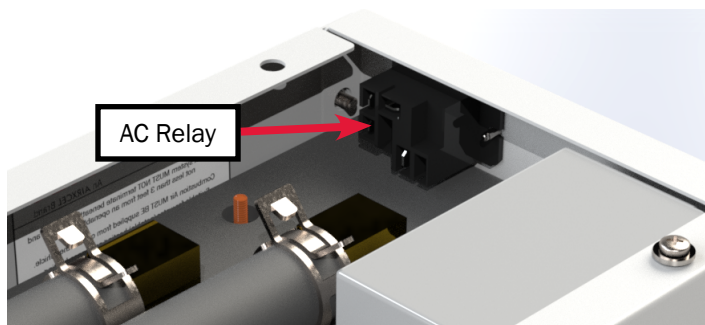

**Figure 66**

### Replacement Procedure:

1. Ensure that the Aqua-Hot has been completely shut down and all power sources have been disconnected. Be sure the boiler tank is completely cooled.
2. Ensure that the RV is not connected to shore power and that a generator is not connected during this procedure.
3. Remove all wires from the relay.
4. Remove the defective relay by drilling the rivets that hold the relay in place (reference Figure 67) and discard the defective relay.
5. Rivet the replacement AC relay to the previous position.
6. Using the wiring diagram on page 49, connect the wires previously removed to the replacement AC relay.

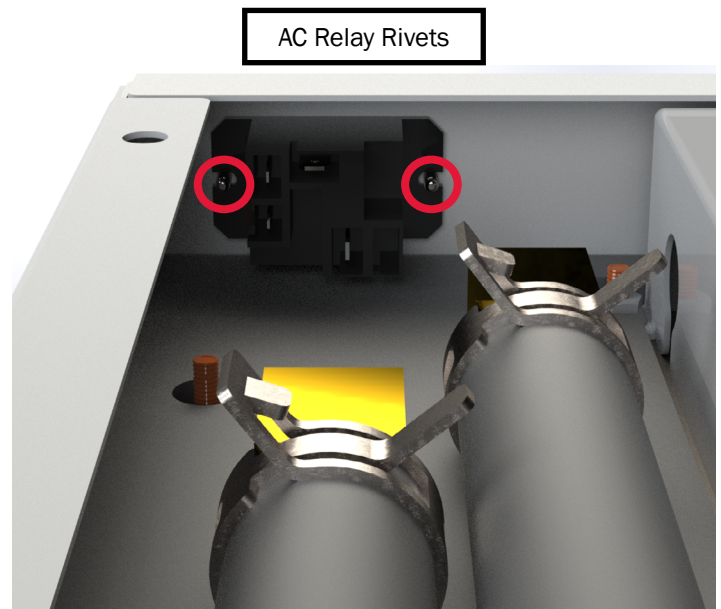

**Figure 67**

## ETS Module

### Introduction:

The ETS (Engine Temperature Sensor) Module is a brass thermistor that continually measures the temperature of the fluid within the Aqua-Hot boiler tank. This module then relays the information to the Aqua-Hot controller, thereby allowing the controller to activate and deactivate the unit as heating and hot water needs change.

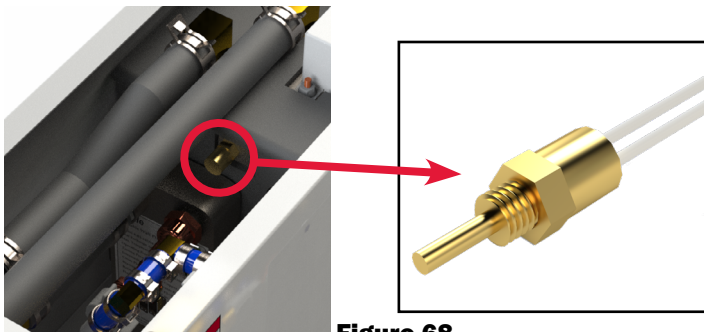

Figure 68

### Troubleshooting Procedure:

Troubleshooting the ETS module is a relatively straight forward process. Follow the instructions below to diagnose the ETS module. Troubleshoot the ETS module if the following conditions have occurred:

- A lack of hot water.
- A lack of interior heat.
- The Aqua-Hot is not operating.

Verify the following before proceeding with the troubleshooting:

- The overflow bottle is adequately filled.
- Ensure that DC electrical power is supplied to the Aqua-Hot.
- Ensure that AC electrical power is supplied to the Aqua-Hot's electric element.
- The high-limit thermostats are not tripped.
- All fuses are in working order.

If any of the above conditions are not met, correct them before continuing with troubleshooting. Results of the troubleshooting procedure cannot be verified if the conditions listed above are not fulfilled.



Figure 70

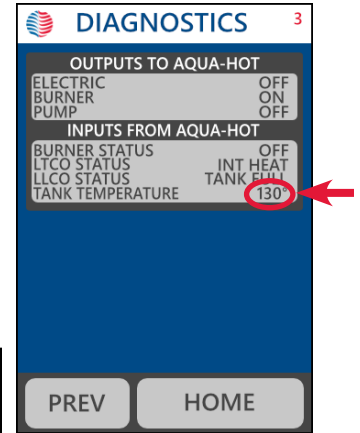
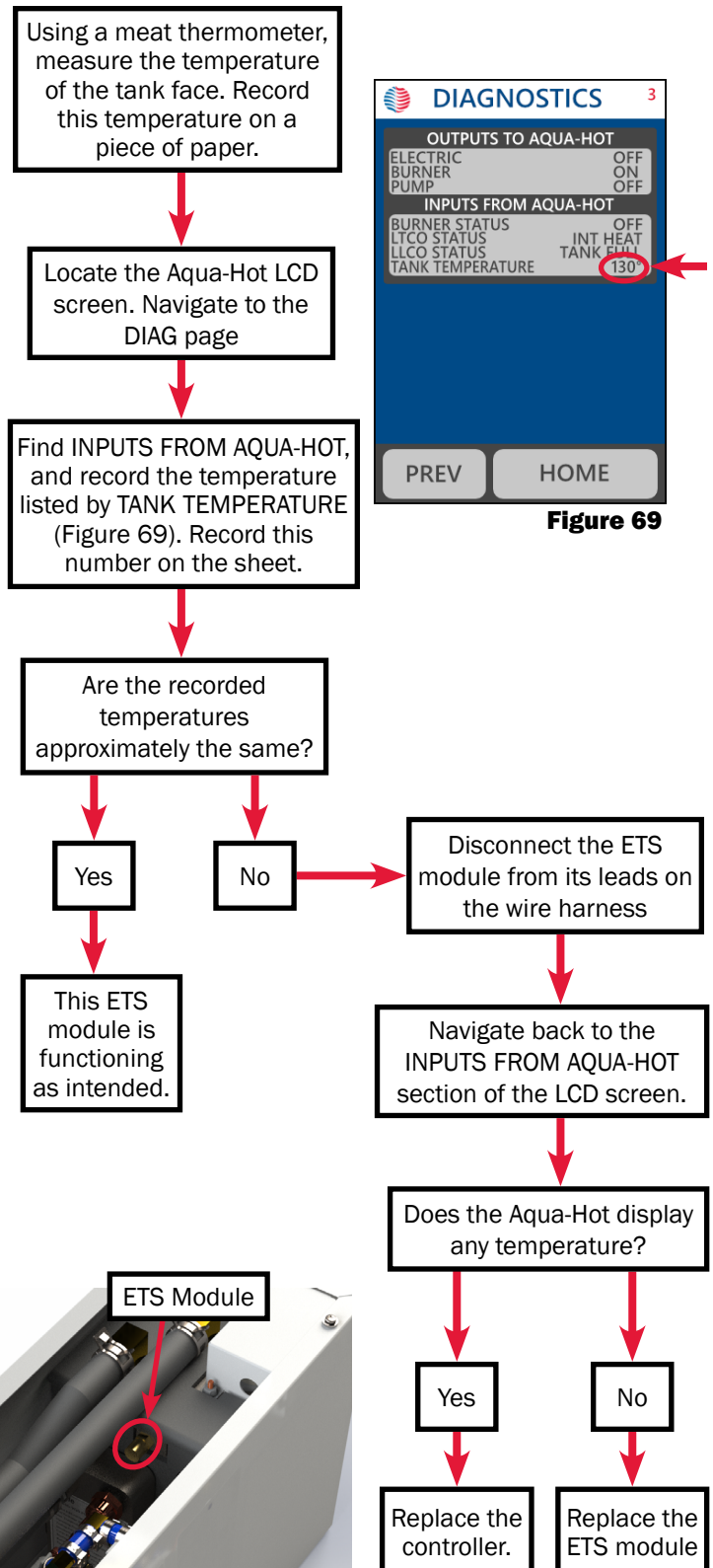

Figure 69

**Replacement Procedure:**

If the ETS Module has been diagnosed and a replacement must be made, follow the instructions below.

1. Drain the unit by clamping the “TO HEAT SOURCE” hose (shown below) located outside the Aqua-Hot, and removing it.



**Figure 71**

2. Allow the fluid to drain into an external bucket or container to be reused later. If necessary, activate the pump to aid in draining the Aqua-Hot.
3. After approximately half a gallon has been drained from the unit, clamp the hose to stop the flow of coolant.

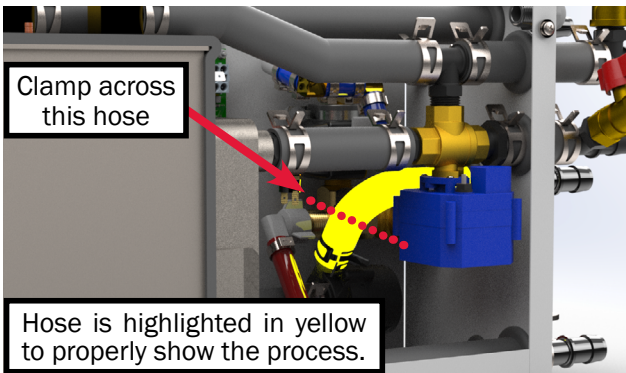

**Figure 72**

4. Disconnect wires from the ETS Module.
5. Using a 14mm wrench or deep socket, remove the defunct ETS module from the tank face and discard it.

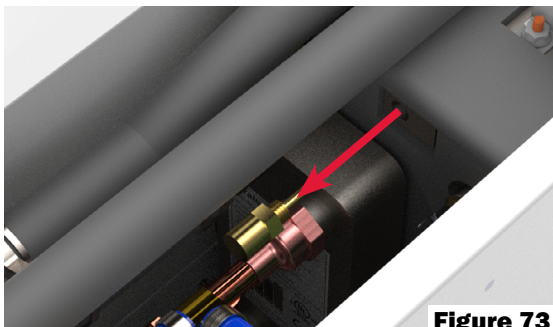

**Figure 73**

6. Place the replacement ETS module in its position on the tank face, and finger tighten it into place.
7. Using the 14mm wrench, tighten the module until it is snug in place.
8. Reconnect the disconnected wires from the harness.
9. Reconnect the “TO HEAT SOURCE” hose to the Aqua-Hot and remove the hose clamp.
10. Pour the previously removed fluid back into the fluid expansion bottle and allow it to fill the Aqua-Hot tank.
11. Once this has been completed, locate the Aqua-Hot LCD screen, navigate to the test section, and run the fluid circulation pump (and if applicable the boost pump) for at least twenty minutes to purge the heating loop of air.

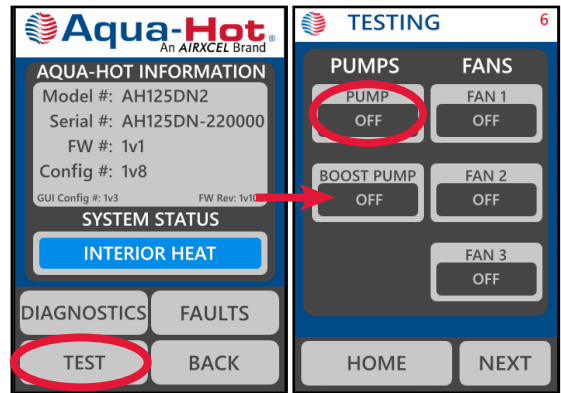

**Figure 74**

12. Continually fill the fluid expansion bottle as the fluid level drops.
13. Test the Aqua-Hot for normal operation.

**FUEL FILTER CLAMPS?**

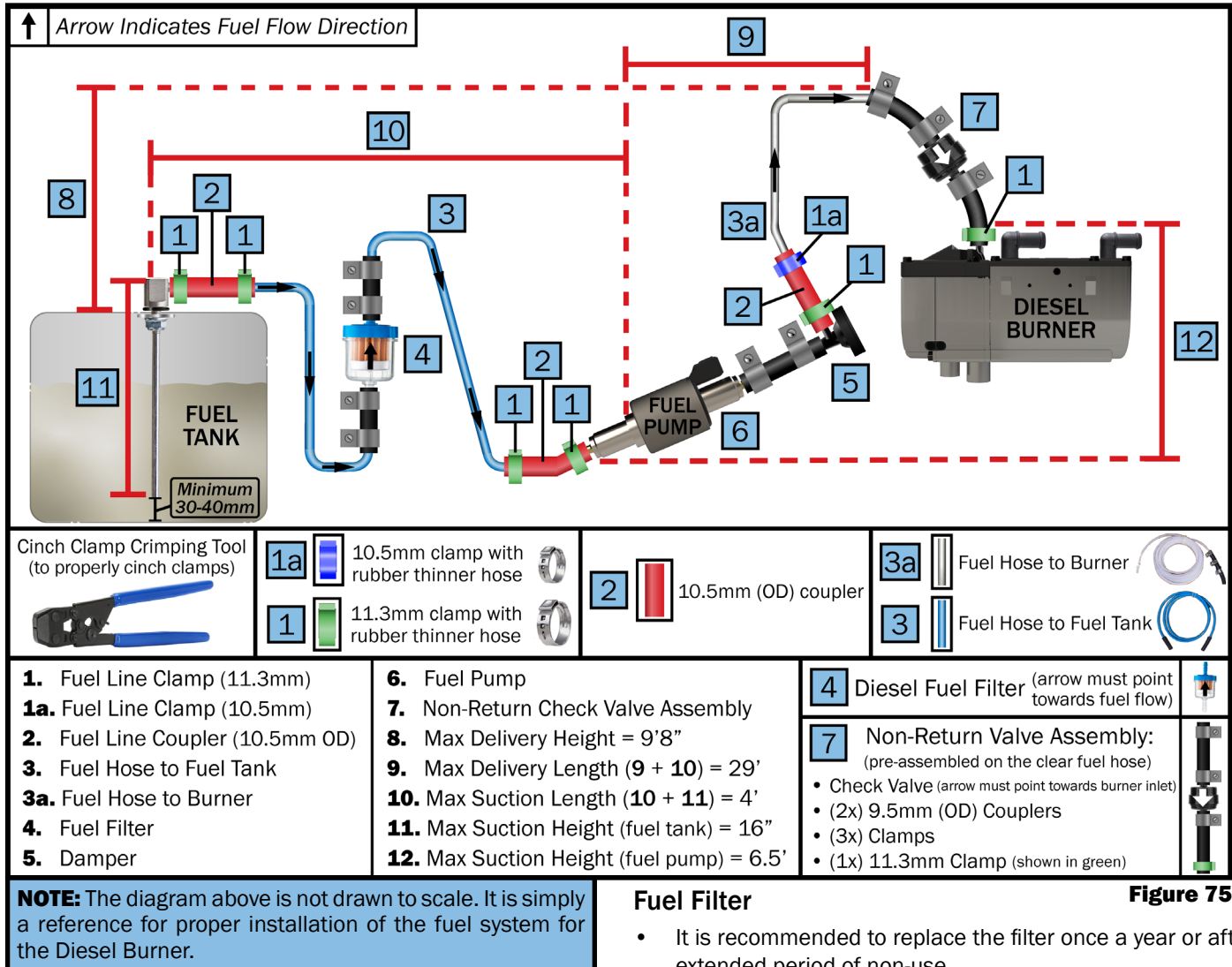

**Figure 75**

**Fuel Filter**

- It is recommended to replace the filter once a year or after extended period of non-use.
- The fuel filter should be installed before the fuel inlet of the fuel pump. Make sure orientation and position of the filter is accurate with the flow of fuel. Reference Figure 75 & 79.

**MORE INFO ON FILTER?**

**Fuel Pump**

- The fuel pump is a combined pumping, metering, and shut-off system. It pumps fuel from the vehicle supply to the burner via the fuel lines.
- The outlet of the fuel pump is required to be installed upwards. The angle should be between 15°-35°. See Figure 77 for fuel pump orientation.

**Fuel System Replacement:**

1. Remove fuel line from the burner before performing the Fuel Purge Procedure (Page 39).
2. Remove any defective part.
3. Check fuel lines, filter, and connections for damage.
4. Replace as necessary. See the diagram above and Pages 38-39 for further instructions.

**Fuel Lines Requirements**

- Please refer to the example diagram shown above.
- Use the provided Ø4mm x 1mm (to heater - transparent) fuel hose and Ø2mm x 5mm (to fuel tank - blue) fuel line with the included couplers and clamps. See Figures 75 & 76

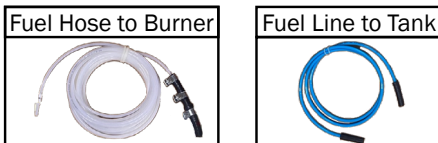

- The fuel hose should not be descending from the fuel pump to the burner - see Figure 75.
- The fuel line should be properly secured to avoid sagging.
- The fuel line must be installed in a manner that won't cause damage to the fuel line (i.e. close to exhaust).
- The fuel line must be secured to the connections and couplers by hose clamps. See Figures 75 & 76.
- Damper installation should be according to the practical situation.

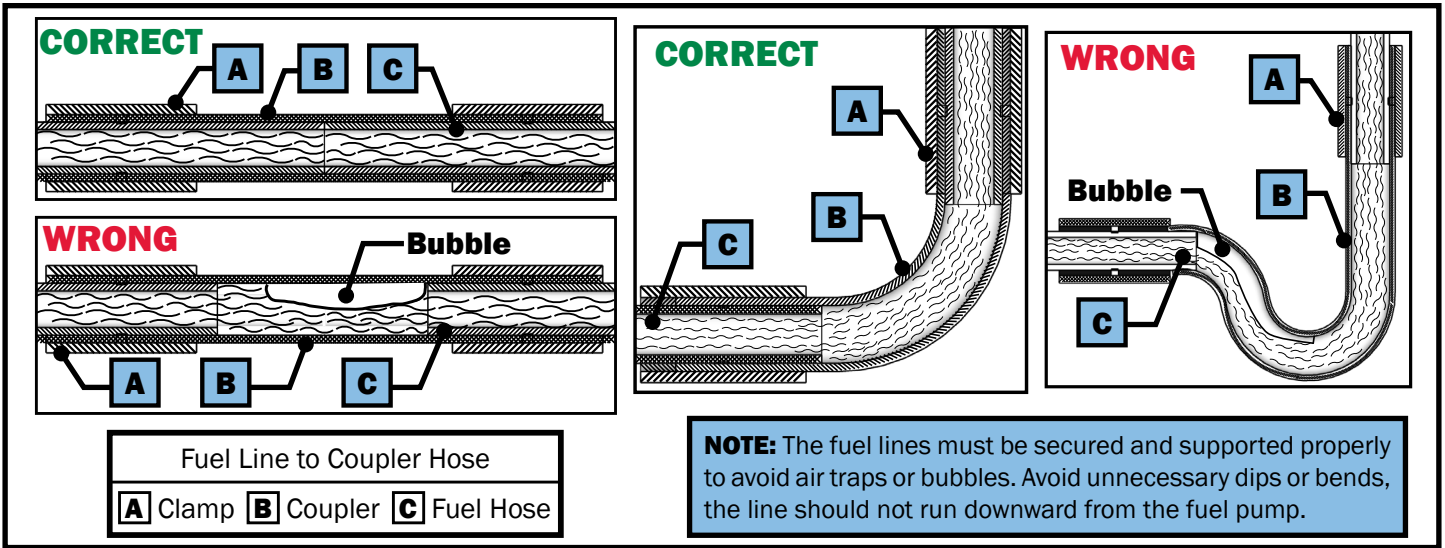

Figure 76

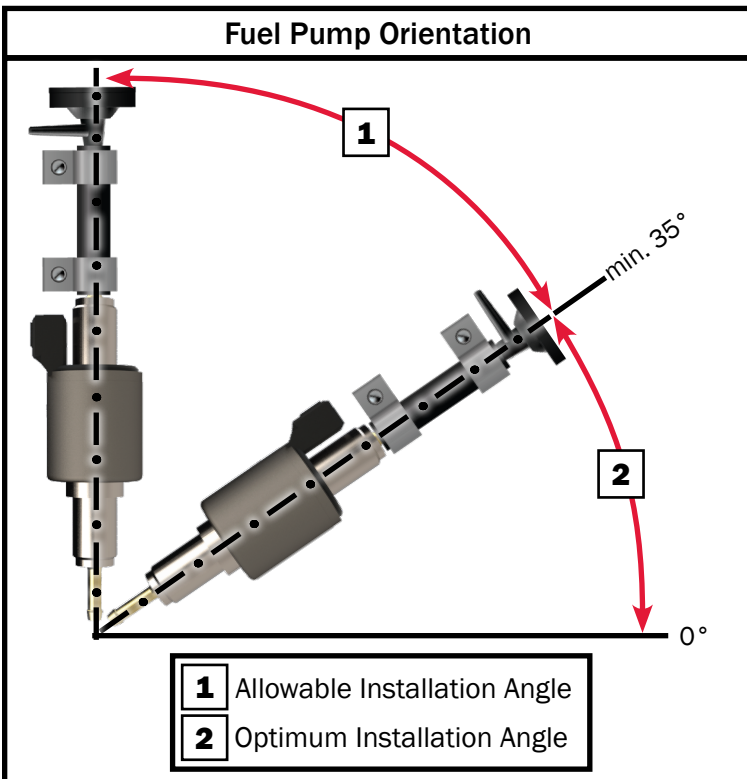

Figure 77

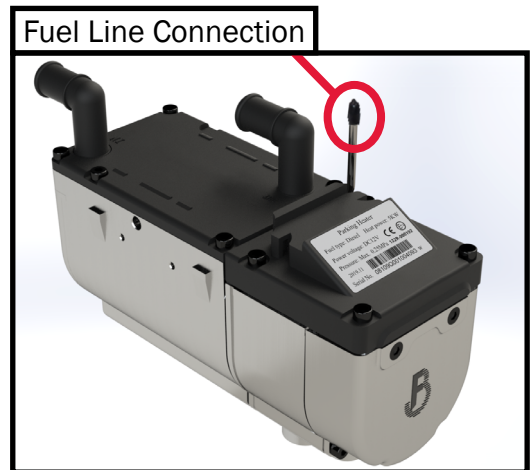

Figure 78

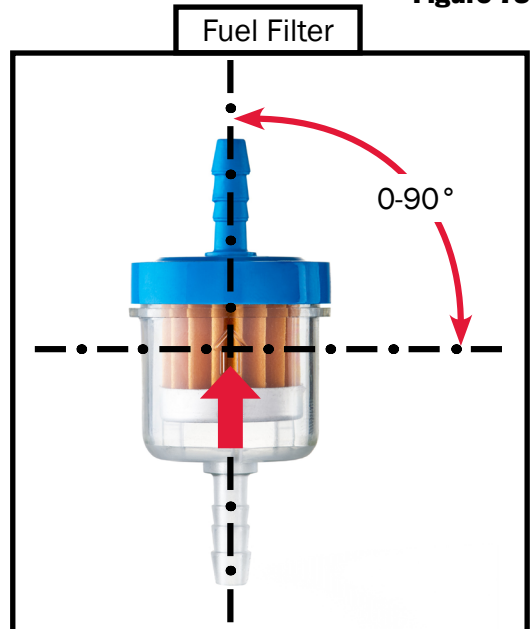

Figure 79

**DANGER**

Fuel can cause fire or explosion that can create severe personal injury or death. Do not store/transport a remote fuel tank *inside* the RV. Notice all applicable codes and regulations for storage, transporting, and handling of remote fuel tanks. Follow instructions to ensure safe operation and check for fuel leaks before operating the burner.

## Fuel Purge Procedure

The fuel lines should be automatically primed with the first operation of the burner. It may take 5-6 starts for the burner to ignite for the first start-up after installation, because the fuel pump needs to fill the fuel lines leading to the burner for ignition. An ignition failure may occur within the first 5-6 starts. Perform this procedure once the burner and Aqua-Hot are completely installed and the Aqua-Hot is adequately filled and purged.

**NOTE:** DO NOT run the diesel burner without the coolant filled and purged as it will cause serious damage to the burner.

**NOTE:** The fuel lines can be fully primed by turning the burner ON/OFF via the LCD screen (Figure 82) without having to direct power and pulse the fuel pump. Once the burner starts and cycles, and any Ignition Failures/Faults are clear, the burner is ready for operation.

1. Connect a 12V power source to the fuel pump to pulse the pump. The power source must be able to be pulsed (turned on and off) rapidly for this process.

## ⚠ WARNING

**Do NOT exceed 12V when powering the fuel pump. This can cause irreparable damage to the fuel pump.**

- The pump can be powered with wire and gator clips. The Pin numbers are labeled below:



Figure 80

- Ground goes to Pin #1
- Power goes to Pin #2
- If you would rather use a plug instead of the wire and gator clips, the mating part numbers needed for the connector are:
  - Housing: 1-967644-1
  - Terminal; 0965906-1
  - Seal: 0-967067-1

2. Pulse the fuel pump at a steady 1-2 pulses per second until fuel begins to come out of the fuel line where it will connect to the burner.
3. Connect the fuel line to the burner.
4. Ensure all hose clamps and fuel fittings are tight and properly secured.
5. Ensure that the exhaust is well ventilated.
6. Turn the burner on at the screen (see Figure 82). The burner should cycle on because of the primed fuel lines.
  - There may be smoke from the exhaust on initial start-up, this is normal.
7. If the burner does not cycle on with the first start up, it will try a second time.
  - If the second start-up fails, there will be a fault message on the LCD screen (Figures 83-84). Tap the burner OFF at the screen.
  - Repeat Step 6.
  - If fault occurs again, repeat Steps 4-6.
8. After a successful start up, run the burner for 5 minutes.

After a complete, successful first operation, the fuel lines should be purged of any air and ready for normal operation and use.

**NOTE:** Once the fuel lines are primed, the fault should clear, but the fault may need to be reset in the process. Just press the RESET button (Figure 84) to clear all the faults.

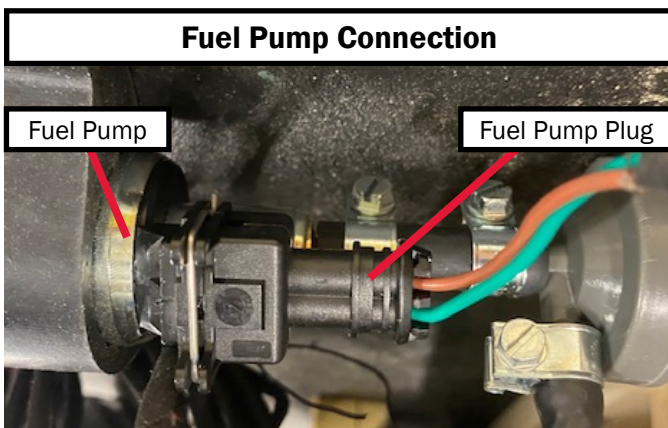

Figure 81

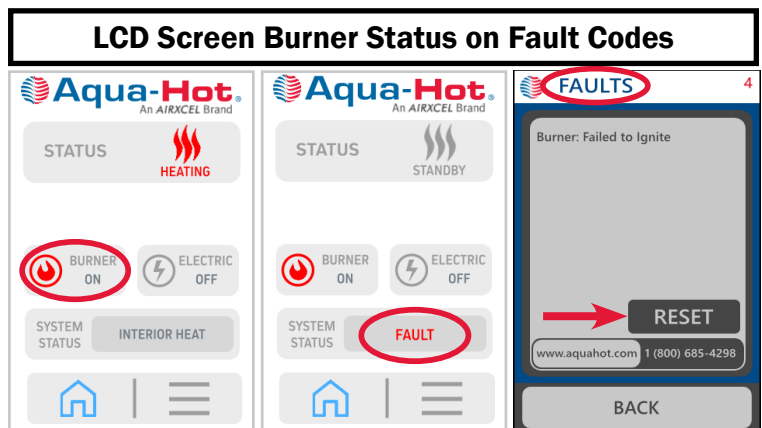

Figure 82

Figure 83

Figure 84

## External Diesel Burner Troubleshooting

The troubleshooting procedures listed below are arranged in order of repair complexity. Do not replace parts without correctly determining the failure. Follow the directions below in order to troubleshoot the diesel burner. Do not skip through the troubleshooting steps, as this may needlessly complicate unit diagnosis and repair.

### Troubleshooting Procedure:

- Ensure that the system is supplied with electrical power and there are no blown fuses.
- Ensure that there is at least ¼ tank of fuel in the vehicle fuel supply and the fuel filter is not clogged.
- Make sure all the electrical and plumbing connections are connected and secure.
- Ensure there are no faults for the burner. If there are, determine the fault and remedy.

The fault is indicated on the diagnostic screen by the Burner Status ON/OFF indicator as shown below. When the burner is turned ON, the LCD screen will show STATUS as “FAULT”. Tapping on FAULT will take you to the FAULTS screen which will display “Burner: Failed to Ignite”. After about a minute, the fault screen will show the specific fault code. Refer to the table on the next page for the fault codes and their remedies.

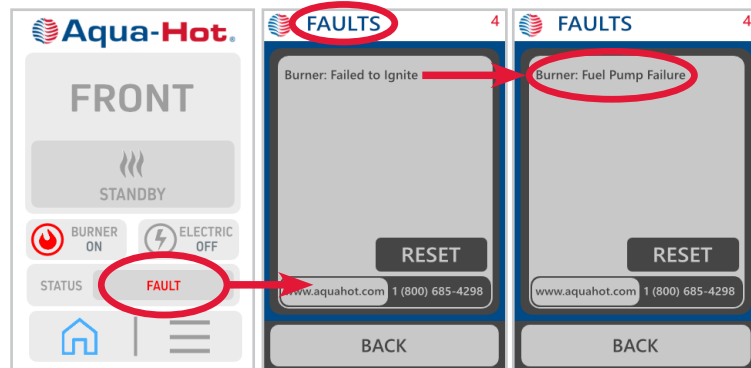

**Figure 85**

### Triggering Overheating Fault:

If there is an overheat fault, the overheat failure is generally caused by the temperature in the Aqua-Hot.

A lack of antifreeze/distilled water solution may cause overheating failures, because the Aqua-Hot temperature cannot be carried away by the antifreeze/distilled water solution.

If the antifreeze/distilled water solution is sufficient and well-circulated, there will be no overheating failure as long as the antifreeze/distilled water solution does not exceed 203°F.

**NOTE:** After the fault cause has been eliminated, the burner must be switched on again.

### Heater Lock-out Reset Procedure

The control unit continuously monitors the heater operation. The control unit identifies errors on individual burner components and faults during operation. Should the control unit experience component errors and operational faults, the burner may be shut down and not restart.

The burner lockout reset must be done manually as shown below.

### Troubleshooting Procedure:

- Turn on the burner, on the interior control panel.
- Remove the main power connection to the burner or pull the fuse for a minimum of 20 seconds.
- Turn the burner off on the interior control panel.
- Reconnect the main power connection that was previously disconnected.



### External Diesel Burner Faults & Remedies

Fault Code	Fault Cause	Remedy	Fault Code	Fault Cause	Remedy
10	Burner: Voltage too high (exceeds 16V)	• Check power supply	51	Burner: Failed to Ignite Combustion chamber temperature is too high prior to ignition	• Wait for flame sensor cooling
11	Burner: Voltage too low (lower than 10.5V)	• Check power supply / battery voltage			• Replace flame sensor (normal resistance about 10K Ω)
12	Burner : Overheat ( > 228.2°F)	• Check coolant level, refill coolant if low after the heater cools down, restart  • Check the circulation pump to see if working properly			52
13	Burner: Failed to Ignite		• Check whether air inlet pipe or exhaust pipe is blocked		
14	Burner: Over-Temp Coolant Overheat		60	Burner: Temperature sensor absent/broken circuit	
17	Burner: Over-Temp - Hardware (> 233.6°F)	61			Burner: Temperature sensor short-circuit
13	Burner: Failed to Ignite Second failure (burner failed to ignite 2 times)	• Check whether fuel pipe is blocked or fuel tank is low • Check whether air inlet pipe or exhaust pipe is blocked	62	Burner: Coolant temperature is too high prior to ignition	• Check flame sensor (normal temperature resistance about 0.8 Ω) • Replace flame sensor
20	Burner: Heat Plug Failure Absent/broken circuit	• Clean up carbon deposits • Replace glow plug • Replace controller	64	Burner: Flame sensor absent/ broken circuit	
21	Burner: Heat Plug Failure Short Circuit		71	Burner: Overheat sensor absent/ broken circuit	
22	Burner: Heat Plug Failure Poor/Reduced Performance				65
23	Burner: Heat Plug Failure Heat Plug Voltage not detected		30	Burner: Fan Speed too high	• Replace burner controller
30	Burner: Fan Speed too high	• Check if fan wheel is binding • Replace fan motor assembly • Replace Controller	72	Burner: Overheat sensor short-circuit	• Check if power voltage is too low • Check if fan wheel is binding • Replace burner controller
31	Burner: Fan absent/broken circuit		84	Burner: Fan speed has not been detected	
32	Burner: Fan has short-circuited				
33	Burner: Fan Speed too low	• Check power voltage • Check if fan wheel is binding • Replace burner controller	<b>Burner: Communication Failure</b>		
41	Burner: Circulation pump absent/ broken circuit	• Check pump wiring • Replace circulation pump	91	Burner: Crystal failed in the controller (crystal oscillator is the "heartbeat generator")	• Check burner harness & connections • Ensure terminals are making contact and wires are in place • Replace burner harness or burner connector if damage is found • Replace controller
42	Burner: Circulation pump short circuit		99	Burner: Fault information invalid	
47	Burner: Fuel Pump Failure Fuel pump short-circuit	• Check fuel pump wiring/connections • Replace fuel pump • Replace controller	E0	Burner: Signal at start-up was not detected	
48	Burner: Fuel Pump Failure Fuel pump absent/broken circuit		E1	Burner: Controller fault	
			E2	Burner: Glow Plug measurement circuit fault	

## General Failure Symptoms of the Burner

This section will cover the typical failures of the diesel burner. Refer to the table more fails and their remedies.

Failure Symptom	Possible Cause	Remedy
Burner switches off automatically (fault lockout)	No combustion after start or automatic repeat start	Switch off burner and switch back on.
	Flame extinguishes during operation	<ul style="list-style-type: none"> <li>Check coolant lines for obstructions, closed valves, and kinks.</li> <li>Check coolant level, purge any air. Allow burner to cool down. Check for failure codes.</li> </ul>
	Burner overheats	<ul style="list-style-type: none"> <li>Charge/replace batteries.</li> <li>Switch off burner and switch back on.</li> </ul>
Heater is letting out black smoke from the exhaust	Combustion air and/or exhaust tube is blocked	Check combustion air intake and or/ exhaust tube.
Burner does not switch on	Heater is without electrical power	Check power supply to the unit and ground connections.
Burner switches off during operation (= fault lock-out)	Burner has overheated due to lack of coolant	Refill antifreeze and water mixture.

## Service of the Burner

The service or maintenance should be done once a year to maintain the functional reliability of the burner. The service and any repairs must only be performed by trained technicians.

Proper preventive maintenance greatly improves the burner performance.

- Visual inspection of the burner for any external damage, fastening, and also external cleaning (make sure power is disconnected before any cleaning).
- Inspect electrical connections for corrosion, making sure they are all properly secured and free of any kinks, cracks, or damage.
- Check the exhaust and combustion air lines for signs of damage and make sure they are clear of debris or any blockages.
- Check fuel lines for any leaks, kinks, cracks, or damage.
- Check plumbing lines and circulation pump to make sure they are properly secured and free of any damage.
- Check the fuel pump and circulation pump for any damage.
- Run the burner for 20 minutes once a month.
- Clean the burner of any debris or dust with compressed air.
- Replace the fuel filter once a year, or after extended period of non-use.



**Figure 86**

The first operation of the burner (after service or maintenance) with the Aqua-Hot may not light up perfectly. It may take 5-6 starts for the burner to ignite for the first start-up after service, because the fuel pump needs to fill the fuel lines leading to the burner for ignition. This is normal and may take a couple tries to get the fuel lines purged of air before a successful start-up.

**NOTE:** Make sure to perform the fuel line purge procedure on Page 39 prior to starting this initial start up of the burner.

## WARNING

**Failure to follow instructions on the fuel delivery system can cause damage to the Aqua-Hot 125-DN2, the diesel burner, or the RV. It may cause serious personal injury. Please follow instructions carefully.**

### Activation Instructions (Diesel Burner)

1. Make sure there are no blockages or debris to the exhaust outlet or combustion air inlet.
2. Make sure the plumbing lines and fuel lines are properly purged and free of air.
3. Make sure there is adequate fuel in the vehicle fuel tank (at the least ¼ tank).
4. Turn on the burner on the heater control screen.

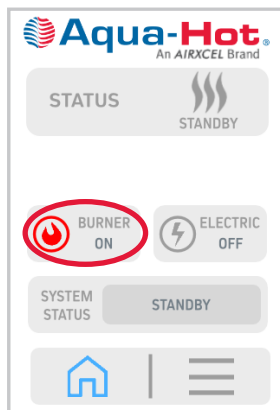

**Figure 87**

5. Once the burner turns on, the circulation pump and combustion air fan should run (can be determined by listening).
6. The burner should start up after approximately 120 seconds. This can be determined by the hot exhaust exiting from the exhaust tube.
7. Allow the burner to run a full cycle. Turn on the heat or hot water inside the RV to confirm the burner is properly operating.

**Once these checks have been confirmed, the diesel burner is now ready for normal operation and use.**

**NOTE:** It is recommended to run the burner for at least 20 minutes every month to ensure optimum heater condition.

## WARNING

**Burn Hazard**

Hot Coolant Circuit with Hot Surfaces can cause severe burns.

**DO NOT** touch or service until equipment has cooled.

LDE-200-810

**NOTE:** Both the electric heating element and the external diesel burner are thermostatically controlled. The element and/or burner will automatically maintain the temperature of the boiler tank's antifreeze and water heating solution.

## Lack of Interior Heat or Hot Water

### Introduction:

A lack of interior heat or hot water when provided with adequate heat from either the electric element and/or the diesel burner can be attributed to an overheat thermostat, the Aqua-Hot controller, the three-way valve, or the fluid circulation pump.

The troubleshooting procedures listed below are arranged in order of repair complexity. Do not replace parts without correctly determining the failure.

Follow the directions below in order to troubleshoot the Aqua-Hot. Do not skip through the troubleshooting steps, as this may needlessly complicate unit diagnosis and repair.

### Troubleshooting Procedure:

- Ensure that the Aqua-Hot is supplied with electrical power.
- Ensure there is an adequate supply of diesel fuel (at least ¼ tank).
- Ensure that the Aqua-Hot boiler tank has an adequate supply of antifreeze and water heating solution by checking the level at the expansion bottle. If the level is low, reference the maintenance section of this guide for refilling instructions.
- Verify the functionality of any in-line fuses connected to the Aqua-Hot. Replace these fuses if necessary.
- Ensure that all RV-side hot water faucets are closed.
- Visually inspect the interior of the Aqua-Hot to ensure that there are not pinched or damaged wires.
- Locate the high-limit thermostats (3) within the Aqua-Hot. Test these thermostats for functionality, and replace them if necessary. Reference page 23.
- Locate and test the ETS module for functionality. Replace if necessary. Reference page 35.
- Locate and test the fluid circulation pump. If necessary replace it. Reference page 30.
- Locate the three-way valve and test it for functionality. Replace if necessary. Reference page 26.
- Make sure there are no faults displayed on the LCD screen. Reference Figure 90.

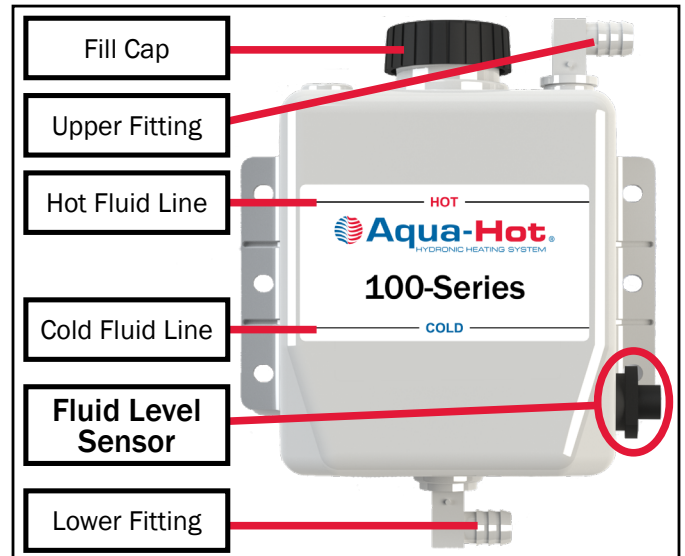

Figure 88

**NOTE:** The fluid level sensor is located in the Aqua-Hot's expansion tank. If the antifreeze solution in the expansion tank drops below the level of the fluid sensor, the Aqua-Hot will not operate.

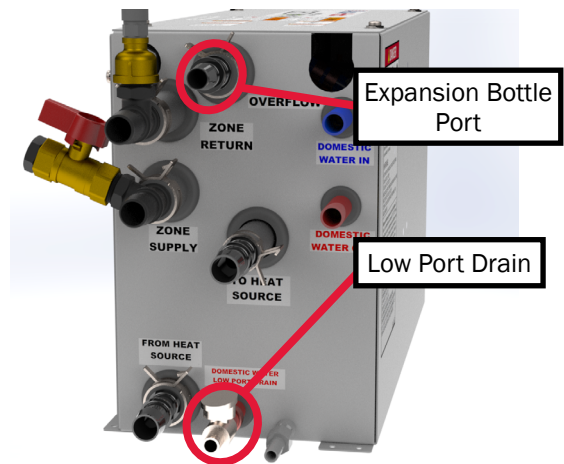

Figure 89

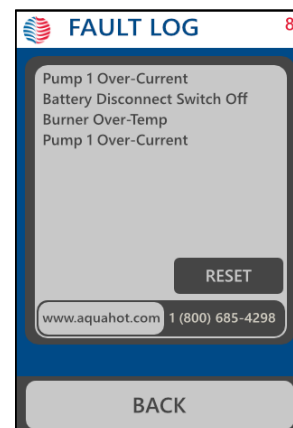

Figure 90

## Winterizing the Aqua-Hot

The Aqua-Hot's domestic water heating system must be completely drained of domestic water at any time the heater is stored where freezing temperatures may be experienced.

Please follow these instructions when winterizing the Aqua-Hot domestic water heating system. Reference Figure 91 below for a system overview.

**NOTE:** The Aqua-Hot can continue to be used for interior heat once the domestic hot water system has been winterized.

1. Completely drain the fresh water storage tank using the Low Port drain (Figure 89).
2. Disconnect the domestic water demand pump suction line from the fresh water storage tank.
3. Attach an adequate piece of hose onto the suction side of the domestic water demand pump.
4. Place the opposite end of the hose into an adequate supply of non-toxic RV winterization antifreeze (FDA certified as "GRAS" Generally Recognized As Safe must be used) and allow the fluid to pump through.
5. Open and close all interior and exterior water faucets one at a time, until ONLY pure RV antifreeze is present. Perform this procedure for both cold and hot water faucets.
6. Remove the hose and reconnect the domestic water demand pump's suction line to the fresh water storage tank.

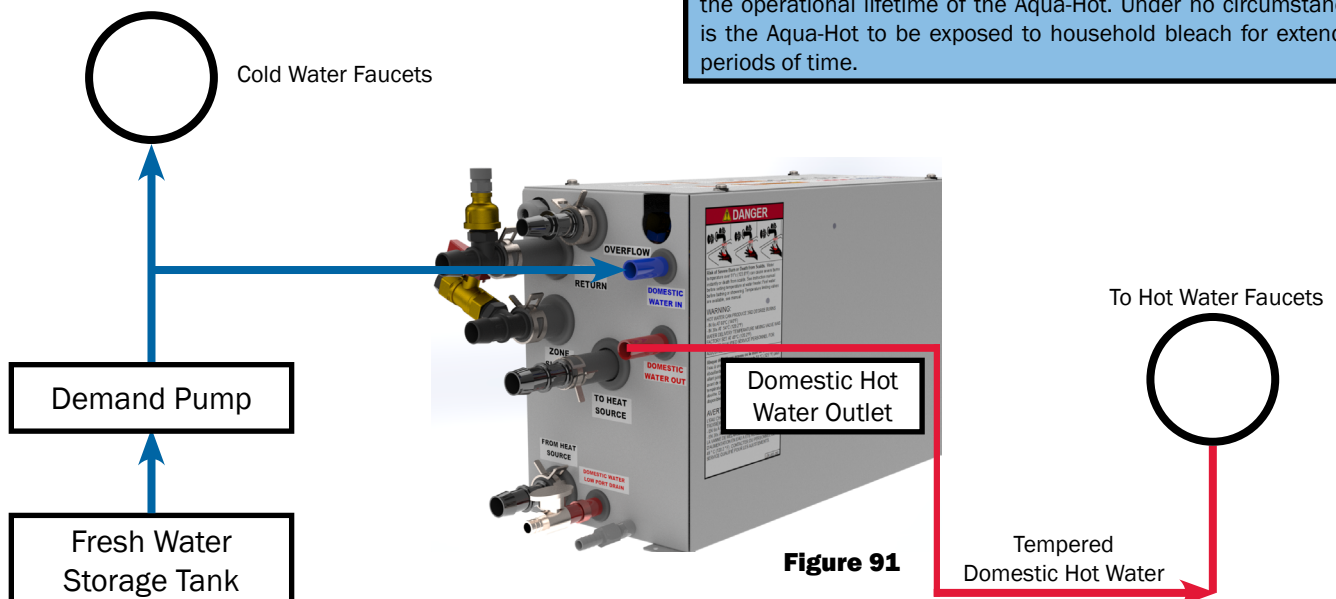

Figure 91



## WARNING

**Not winterizing the Aqua-Hot when freezing temperatures are present will result in serious damage to the Aqua-Hot domestic water heating system. Ensure that only non-toxic RV antifreeze (FDA-approved "GRAS" antifreeze) rated for winterization is used when winterizing this unit. The warranty does not cover freeze damage.**

## NOTICE

### Disinfecting the Domestic Water System

The Aqua-Hot Heating components are not compatible to prolonged exposure to sodium hypochlorite (bleach or liquid bleach). Using products containing bleach, including water refreshers, may cause corrosion of the domestic water lines, resulting in a catastrophic failure of the Aqua-Hot system by creating leaks that cannot be repaired. This damage is not covered by the Aqua-Hot warranty.

If disinfecting the hot water system, be sure to follow NFPA 1192 Standard of Recreational Vehicles "Instructions for Disinfection of Potable Water Systems" or any other applicable local standards for Potable Water Systems.

**NOTE:** Extended exposure to household bleach will corrode the components of the Aqua-Hot will potentially dramatically shorten the operational lifetime of the Aqua-Hot. Under no circumstances is the Aqua-Hot to be exposed to household bleach for extended periods of time.

**PIN OUT INFORMATION**

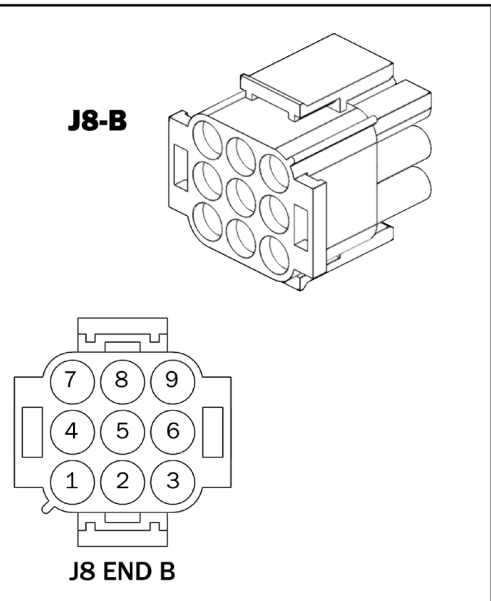
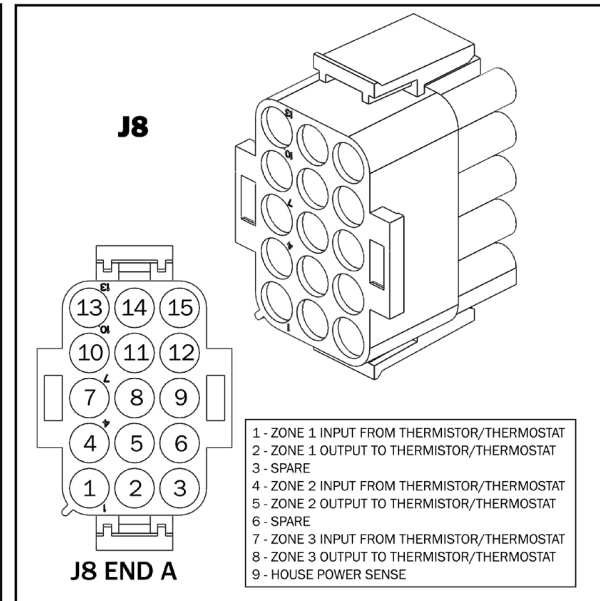
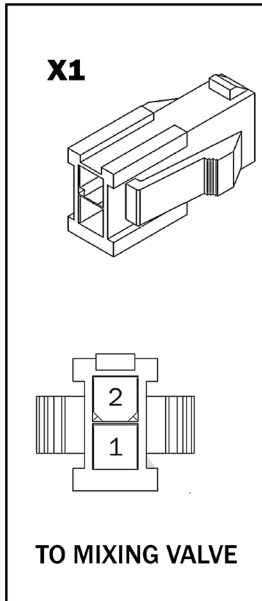
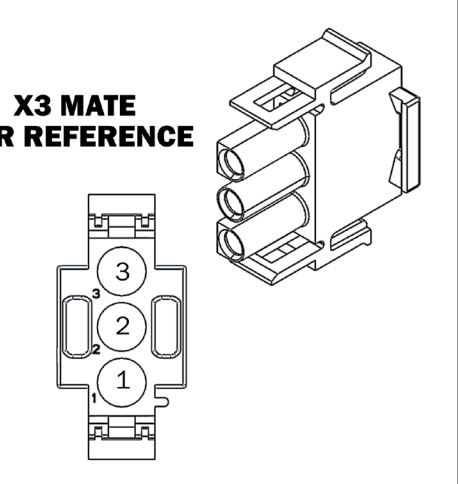
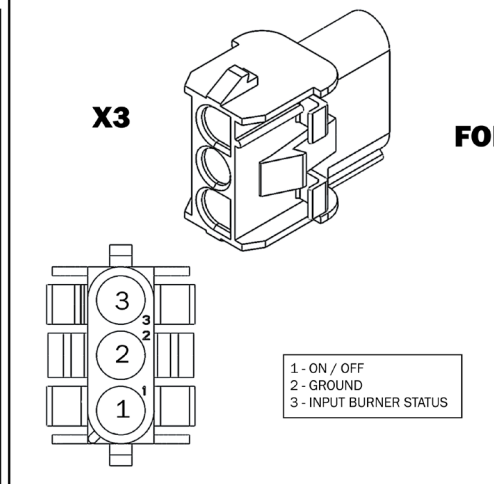
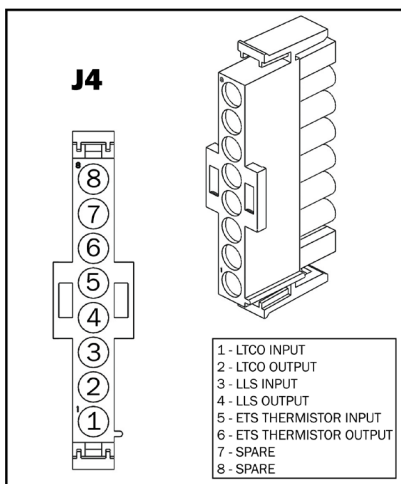
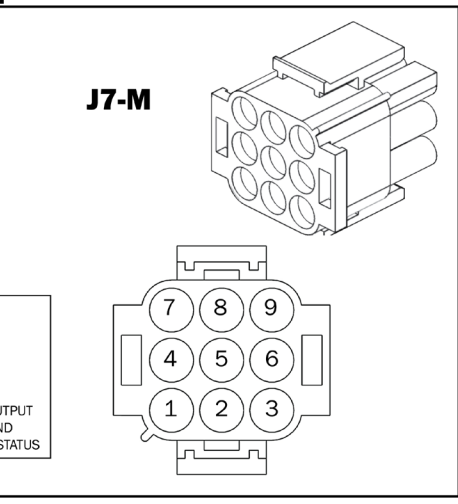
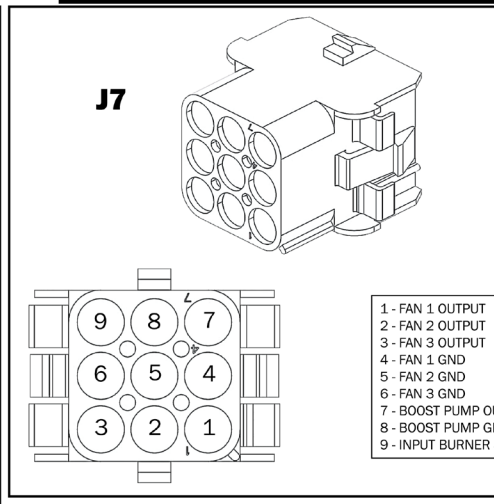
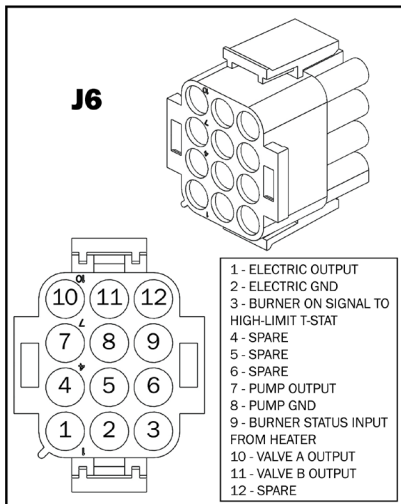

**NOTE:** All connectors are shown from Pin insertion side.

CONNECTOR	MATE PART #	FLAMMABILITY RATING
J4	640582-1	UL94V-0
J6	1-480708-0	UL94V-2
J7	1-480706-0	UL94V-2
J8	1-480710-0	UL94V-2

CONNECTOR	SOCKET PART #	WIRE SIZE RANGE (AWG)
J4	350550-1	20-14
J6	350550-1	20-14
J7	350550-1	20-14
J8	350550-1	20-14

**ZONE HEAT EXCHANGERS & ZONE THERMOSTATS**

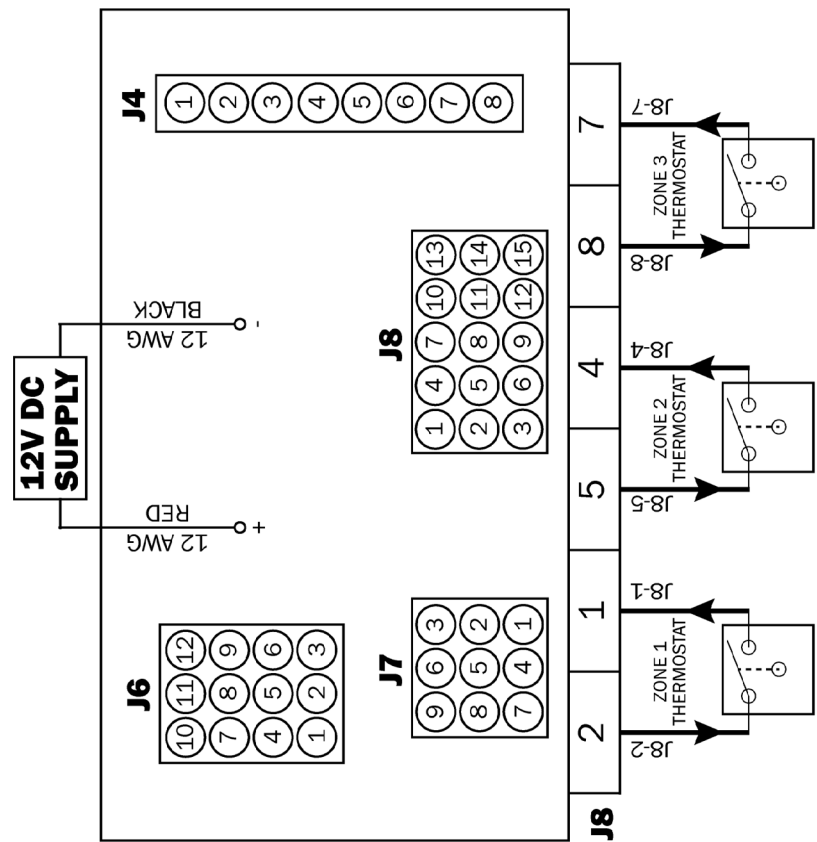
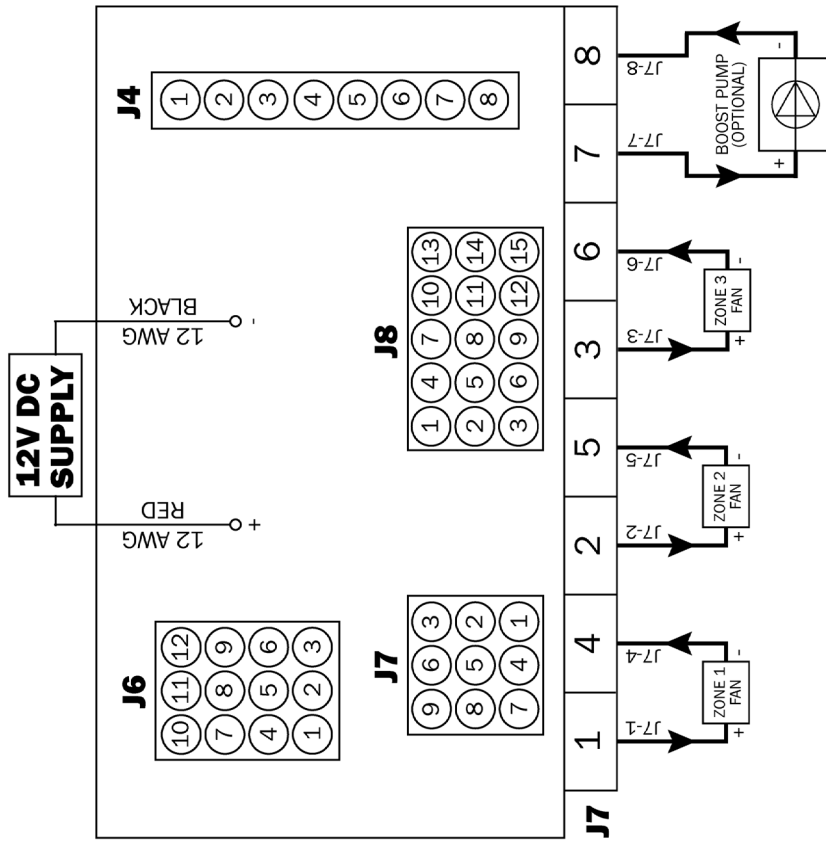

**EXTERNAL DIESEL BURNER**

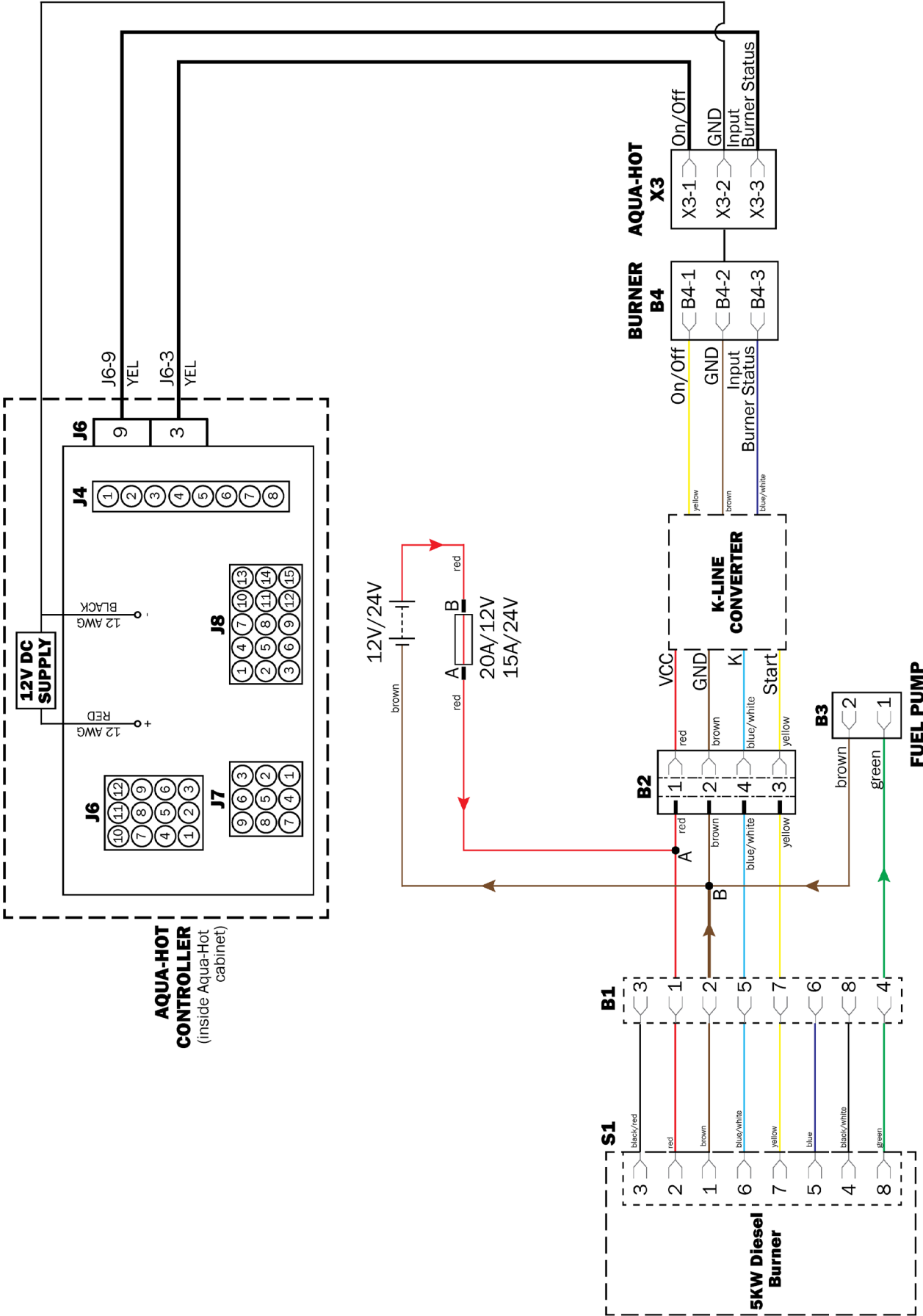



**SENSORS, THERMOSTATS, ELECTRIC ELEMENT**

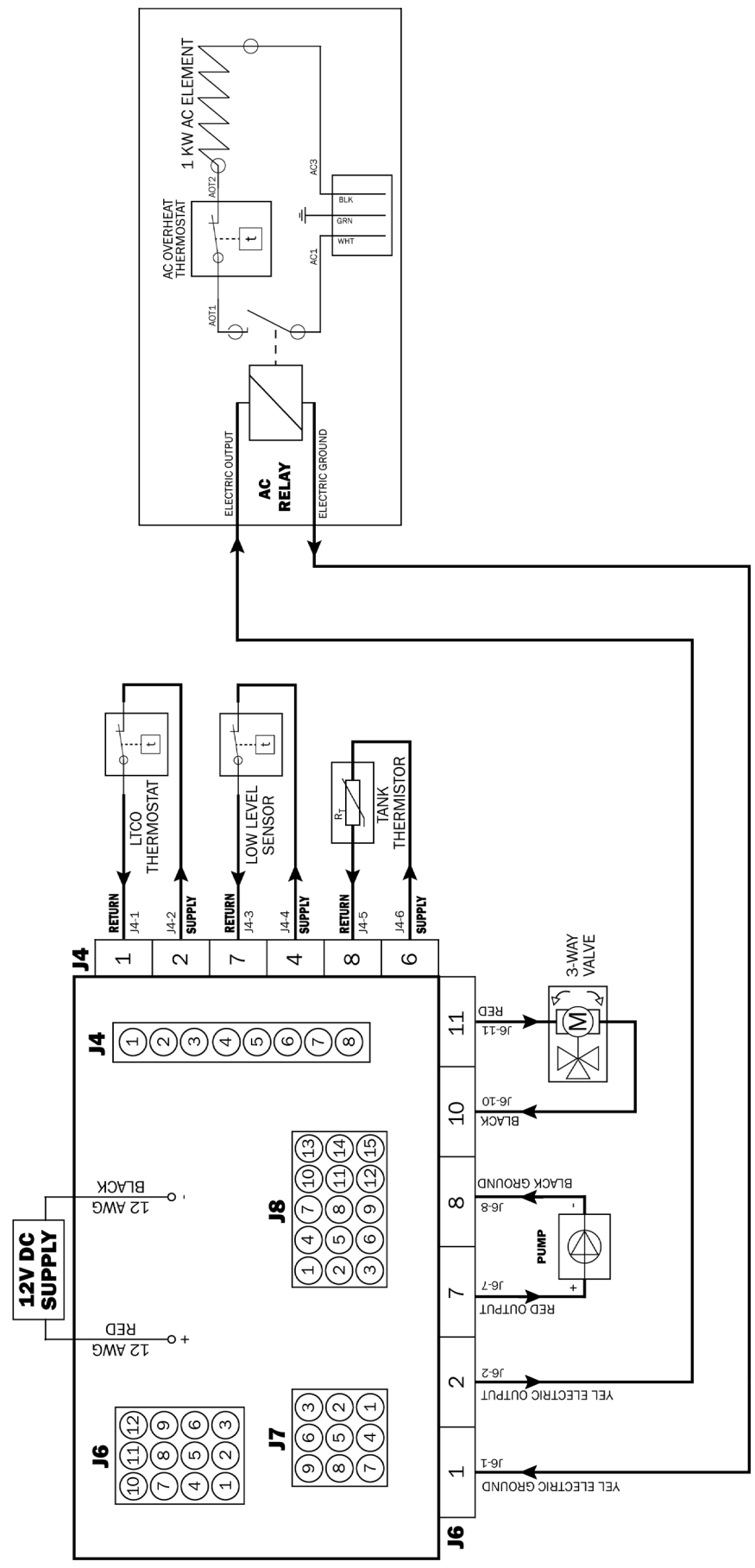

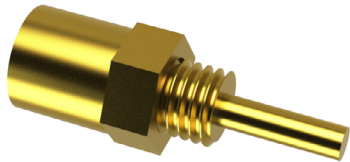

[ELE-014-711](#)

Thermistor, Tank Temperature Sensor



[ELX-THM-309](#)

Thermistor, 10K NTC, Room Temperature Sensor



[ELE-LCD-050](#)

Aqua-Hot LCD Screen, RVC 3.5in



[ELE-125-200](#)

RV-Side Wire Harness (optional)



[ELE-RVC-100](#)

RVC Display Cable

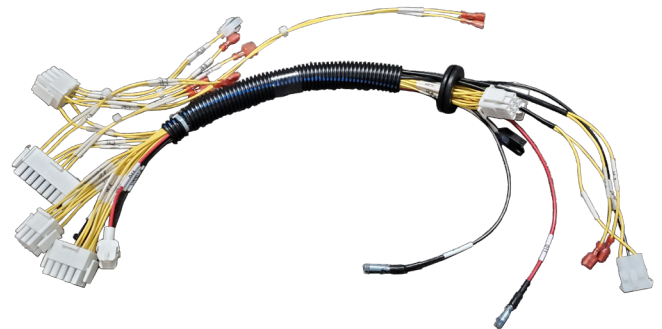

[ELE-125-100](#)

Aqua-Hot Series 125 Mainframe Harness

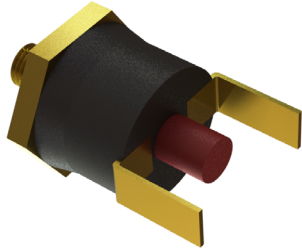

[ELE-HLT-426](#)

VAC High Limit Thermostat 215° F w/ Leads

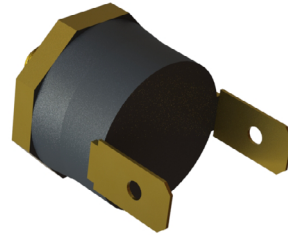

[ELE-LTC-200](#)

Low-Temperature Cutoff Thermostat w/ Spade Terminals

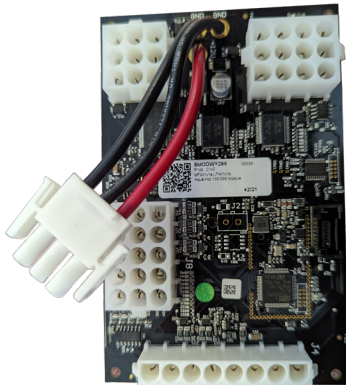

[ELE-100-010](#)

Controller, 12VDC, 100-200 Series, Kit



[ELX-2E7-102](#)

1500W, 120 VAC Electric Element, 1" NPSM



[EXE-103-OEX](#)

Heat Exchanger, Cozy III

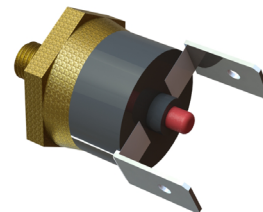

[ELE-HLT-425](#)

VAC High Limit 215° F Thermostat w/ Spade Connectors

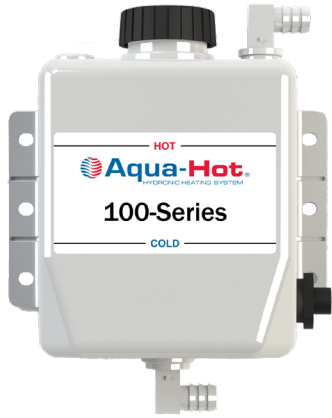

[PLE-063-200](#)

3 Qt. Expansion Tank w/Internal Fluid Level Sensor, 5/8" Barb



[PLX-100-900](#)

Fluid Circulation Pump

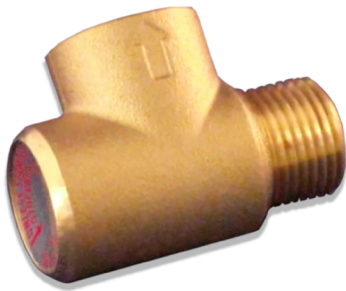

[PLX-111-125](#)

Pressure Relief Valve, 125 PSI



[ELE-400-900](#)

Harness, Buehler C20 Pump

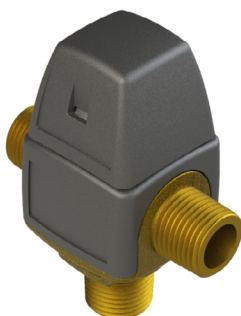

[PLX-362-100](#)

Tempering Valve

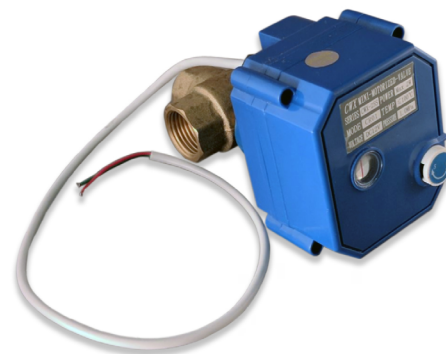

[PLX-125-3WV](#)

Kit, Three-Way Motorized Valve, 1/2" NPT

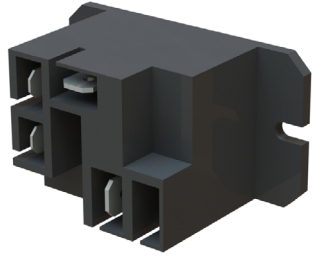

[ELX-232-948](#)  
AC Relay, 30A 277VAC

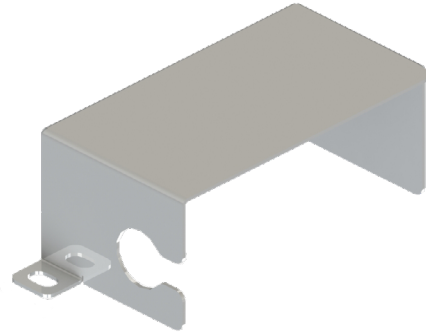

[SME-102-080](#)  
Cover, AC Element Cover for 125 Series



[PLX-000-200](#)  
Hose, 5/8" Safety Stripe, Rubber



[GBX-125-117](#)  
Assembled Fuel Pump



[GBX-125-XXX](#)  
Diesel Burner Fuel Filter

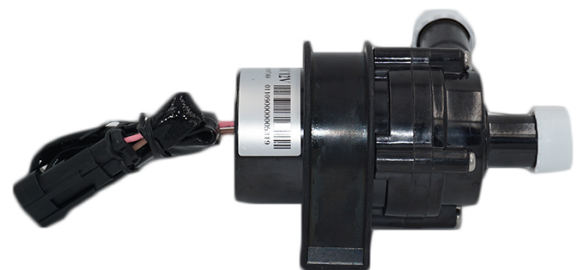

[GBX-125-103](#)  
5kW Diesel Burner Circulation Pump



[GBX-125-121](#)

Fuel Hose to Burner (clear) (Couplers & check valve included)



[GBX-125-122](#)

Fuel Hose to Fuel Tank (blue)



[HDX-102-111](#)

Clamp, (10.5mm), Soft Hose and Tube



[HDX-102-113](#)

Clamp,  $\frac{3}{8}$  to  $\frac{7}{16}$  (11.3mm), Soft Hose and Tube

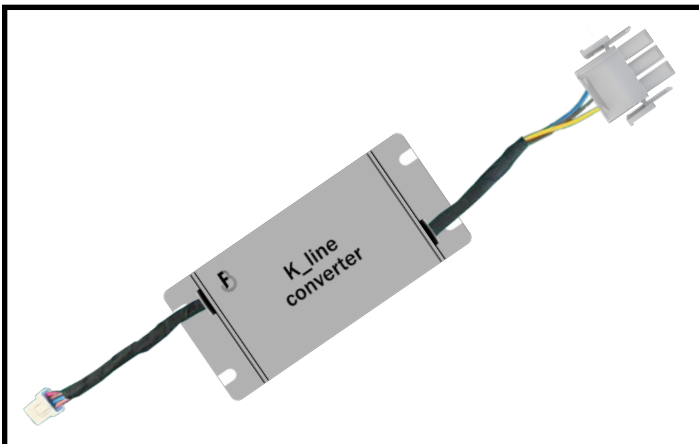

[GBX-125-102](#)

Burner K\_Line Converter



[GBX-125-112](#)

Burner Wiring Harness

## Measuring Antifreeze Using a Refractometer

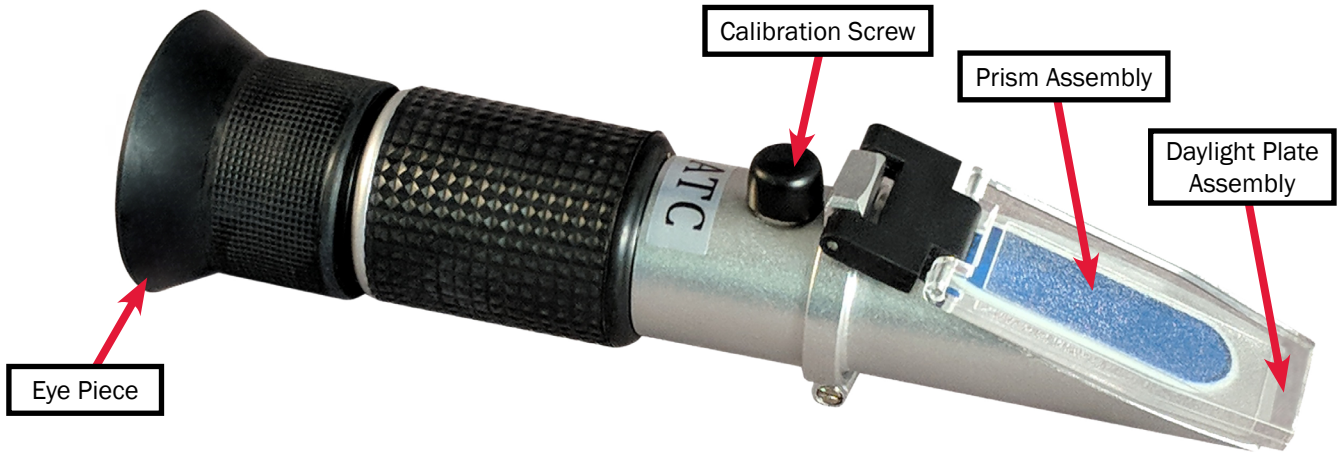

### Properly Apply Antifreeze to the Prism Assembly

Use the guide below to properly apply the ethylene glycol mixture to the prism assembly of the refractometer. Once that is complete, peer through the eyeglass of the refractometer to continue to the next step.

### Adjust the Boundary Line

Once the glycol solution has been properly applied, adjust the calibration screw until the boundary line labeled “Ethylene Glycol” is set to 32 °F. The graphic to the right has been designed as an aid, but note that it may differ from what is shown in the refractometer sight glass.

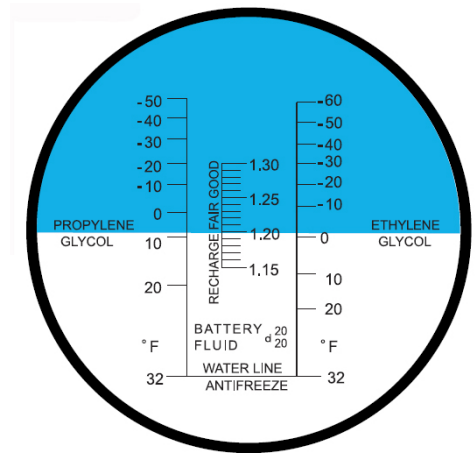

Refractometer Sight Glass

### Application of Ethylene Glycol

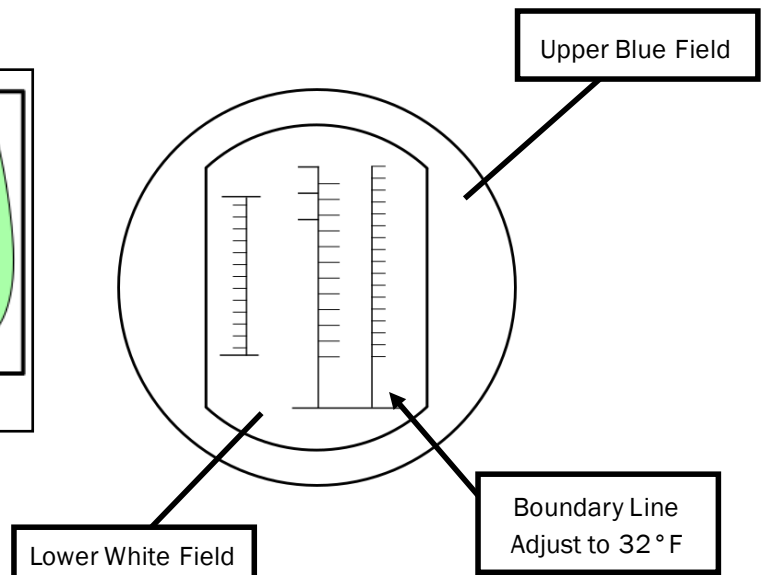
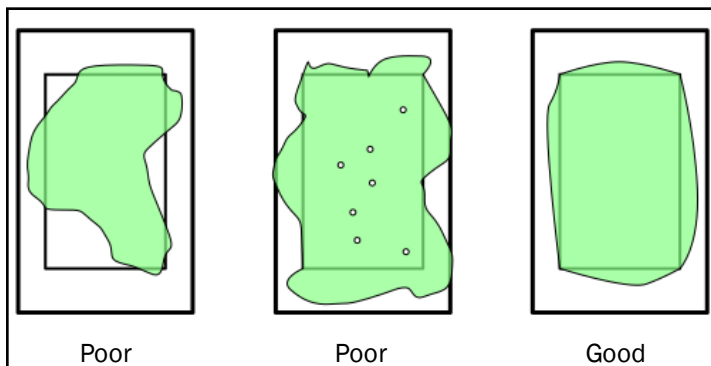



## AQUA-HOT™ (2) YEAR LIMITED WARRANTY

Aqua-Hot Heating Systems Inc. warrants the AQUA-HOT heater to the original owner to be free from defects in material and workmanship under normal conditions of designed usage and service as outlined in the installation and operator manuals for a period of two (2) years covering both parts and labor beginning on the date of purchase of the vehicle by the original owner. Replacement parts are covered for the remainder of the heating systems warranty. All purchased replacement parts will carry a six months, (180) days warranty.

This warranty does not apply to scheduled maintenances items such as fuel filters and fuel nozzles, damage or failure of the AQUA-HOT heater or the vehicle into which it was installed due to improper installation, assembly, maintenance, abuse, neglect, accident, or the use of parts not supplied by Aqua-Hot Heating Systems, Inc. Aqua-Hot Heating Systems is not responsible for incidental or consequential damages.

The intent of this warranty is to protect the end user of the heating system from such defects, which might have occurred in the manufacture of the product. The warranty is not intended to protect the end user from problems, which are outside the ability of Aqua-Hot Heating Systems control.

To obtain a warranty repair authorization or information, please contact the Tech Support Department at 1-800-685-4298 (7:00am to 4:00pm Mountain Standard Time).

### **My Comfort Zones are On-Board**

Vehicle:

#### **Purchased From:**

Dealer Information:

Name:

Location:

Phone Number:

#### **Heating System:**

Serial Number:



Scan the QR code on the right with your mobile device to take you to the website to register your Aqua-Hot product.



Service Manual

# 100<sub>SERIES</sub>



AHE-125-DN2



Aqua-Hot Heating Systems, LLC  
7755 Miller Drive, Frederick, CO 80504

Visit us online at [www.aquahot.com](http://www.aquahot.com)  
Call us at (800) 685-4298 or (303) 651-5500

©2024 Aqua-Hot Heating Systems, LLC. Printed in the USA