

Installation Manual

100 Series



AHE-125-DN2



Contents

Introduction	1
System Overview	4
System Specifications.....	5
Installing the Aqua-Hot	9
Installation of the Expansion Bottle.....	10
Mounting the Burner to the Vehicle.....	11
Combustion Air System.....	12
Exhaust System.....	13
Connecting the Burner to the Aqua-Hot.....	17
Burner Connections	18
Plumbing Requirements.....	19
Wiring the Aqua-Hot	20
House Power Sense	22
Connecting the 125-DN2 to 12V DC Power	23
Connecting the Aqua-Hot to AC Power	24
Heat Exchanger Installation Requirements.....	25
Mounting the Heat Exchangers.....	27
Wiring the Heat Exchangers	28
Plumbing the Heating Zone.....	29
Domestic Water System.....	31
Mounting the Aqua-Hot LCD	32
Operating the LCD & Aqua-Hot.....	33
Configuring the Zones.....	35
RV-C Network Connectivity	36
Filling the Aqua-Hot.....	37
Purging the Interior Heating Loop.....	38
Fuel System	39
Fuel Purge Procedure	43
External Diesel Burner Troubleshooting	44
System Checks.....	47
Aqua-Hot First Operation	48
Winterizing the Aqua-Hot	49
Flow Diagram.....	50
System Schematics.....	51
Measuring Antifreeze Using a Refractometer	55
Parts & Accessories	56
Warranty	62

Caution Notes

As you read this information, take particular note of the NOTICE, CAUTION, WARNING, and DANGER symbols when they appear. This information is important for safe and efficient use of the Aqua-Hot system.

NOTICE signals a situation where potential damage to the Aqua-Hot could occur.

NOTICE

CAUTION signals a situation where potential harm or risk of minor or moderate injury could occur if you do not follow instructions.



CAUTION

WARNING signals a hazardous situation where potential harm, risk of serious injury, or death could result if instructions are not followed.



WARNING

DANGER signals a situation where immediate risk of serious injury or death will result if instructions are not followed.



DANGER

DANGER

NOTE: This manual will also use notes sections similar to this one to draw attention to features and practices which must be observed.

Read all instructions before installing the Aqua-Hot unit and the external diesel burner. Aqua-Hot Heating Systems is not liable for damage resulting from failing to follow instructions contained in this, and any other Aqua-Hot documentation relevant to this unit.

- Read this manual before installing or using the Aqua-Hot System to reduce the risk of injury to persons or damage to the equipment.
- The product identity label contains specifications of the unit, to what standards it has been tested, and important safety notices.
- Disconnect electric wiring to the Aqua-Hot System before welding or plasma cutting the RV to avoid damage to equipment.
- The Aqua-Hot tank and heating loop operate at 0.0 PSI (zero pressure system). Air pressure to the tank must not exceed 18 PSI. Exceeding this rating will cause internal damage to the Aqua-Hot.
- Use caution when working on or near any propane/diesel fuel system.



- DO NOT connect the 12-volt DC power to the Aqua-Hot if the vehicle requires welding.
- At maximum operating temperature, the coolant will be very hot and scalding. Hot vapor or coolant may cause in serious burns or injury. Be aware of hot surfaces.
- Use special caution when children are present. Children must not be allowed to play with the heater or perform cleaning and maintenance.
- Installation and repairs may only be carried out by an authorized, factory-trained Aqua-Hot technician. The heating system must be installed in accordance with local codes, or in accordance with the Standard for Recreational Vehicles, (RVIA) ANSI A 119.2/NFPA 501C, NFPA 1192.
- At maximum operating temperature, the hot air outlet will be very hot that may result in serious burns or injury. Be aware of hot surfaces.
- The diesel burner must be installed in a location that is closed off from living quarters and accessible only from the exterior of the vehicle.
- The burner produces very hot temperatures that can ignite surrounding flammable materials. The burner should be turned off when loading or unloading flammable materials.

Safety Features

Low-Voltage Shutdown

The Aqua-Hot Controller is designed to operate between 11V DC and 16V DC. If the Controller detects that it is receiving voltage below 11.8V DC, a System Voltage fault will trigger a display on the LCD screen. If the Controller system drops below 11.2V DC for 30 seconds, it will discontinue operation of the Aqua-Hot heating system.

Over-Current

An Over-Current fault condition occurs when too much current is drawn by a component, usually a fan or pump. When this fault is triggered, the output channel is shut off until the system has been reset or power-cycled.

Over-Temperature

An over-temperature fault will occur if your Aqua-Hot heating system has reached 218° F. The Controller will deactivate the heater and display an over-temperature fault on the LCD display screen.

Low-Level Cutoff

If the system senses low fluid levels, the heating system will shut down all fans, heat sources, and pumps until the unit is adequately refilled.

House Power Sense

The Aqua-Hot Controller contains within it a fail-safe functionality known as House Power Sense. This functionality serves as a live signal to the Aqua-Hot allowing it to continue operating. If power is lost to the on-board RV-C network or other on-board control systems, the controller is signaled to shut down operation until a 12V DC power signal is returned to the unit.



WARNING!

Read and understand all instructions **before** installing the Aqua-Hot unit and the external gas burner. Aqua-Hot Heating Systems is not liable for damage resulting from failing to follow instructions contained in this, and any other Aqua-Hot documentation relevant to this unit.

Improper installation, adjustments, service and maintenance can cause personal injury or loss of life. Reference the installation and user manuals **before** installation or service.

Contact your authorized service or Aqua-Hot Heating Systems if you have any questions **before** starting installation.

Safe Installation of the Diesel Burner

Be sure to become familiar with the installation process and the documentation before installing in the vehicle.

- Make sure to protect the burner during installation. Do not drop or stand on the burner.
- Avoid abruptly shutting down the burner prior to the purge cycle. The burner fan will continue to run for several minutes after being shut off to cool down and purge unused fuel.
- Only turn off the burner at the control panel in the interior of the vehicle.
- Do not disconnect the 12V DC power supply prior to the purge cycle.
- Only shut down the burner via the battery disconnect in the case of an emergency or danger.
- Do not allow the wiring or wiring harness to come into contact with sharp edges on metal panels. The wires can become damaged and short circuit and potentially cause a fire. Use caution when installing the wiring.
- Protect any vehicle parts near the burner from excessive heat damage, or from contamination from fuel.
- Make sure the internal combustion burner will not pose a fire hazard even in an overheat situation. Take care in placing the burner with enough space from vehicle parts and that the burner will have ample ventilation.
- The serial label must be visible and legible after the burner has been installed.
- All precautions must be taken to minimize the risk of personal injury or damage to the burner or vehicle.
- It must be obvious to the user when the burner is switched on or off.
- The burner may not be mounted in a position above the 125-DN2 expansion tank.

Fuel Supply

- Do not use the heater in enclosed spaces such as a garage. The fumes produced from the exhaust can be toxic. Do not use the burner while refueling or while other appliances are being serviced or refueled.
- The fuel filler neck should be installed in a compartment that is closed off from living quarters and must have a tightly fitting cap to prevent any fuel leaks.
- A visible, legible sign must be attached to the filler neck that the burner be turned off before refueling. A similar warning is included in the manufacturer's operating manual.
- The diesel fuel filter is to be replaced every year for optimal performance.

Exhaust System



WARNING

- Do not operate the burner in an enclosed space or a space that does not have exhaust ventilation. Fumes from the exhaust may be toxic.
- The exhaust system must be positioned so that the fumes will not get into the interior of the vehicle through ventilation openings or windows.

Combustion Air Inlet

- The burner combustion chamber air must not be taken from the interior of the vehicle, only fresh air from the exterior.
- An intake line is required for the combustion air.
- The air inlet must be positioned in an unobstructed manner.



CAUTION

As with any appliance, allow the Aqua-Hot to completely shut down BEFORE disengaging the RV 12V power disconnect.

NOTE: Aqua-Hot recommends regular exercise of the Aqua-Hot heating system to avoid issues with starting after a several-month idle period.

Should additional assistance be needed, please contact the Technical Support team at 574-AIR-XCEL (574-247-9235), Monday through Friday, between 7:00am and 4:00pm MST. You can also email the service department at servicedept@aquahot.com.

All vehicle installations must comply with the requirements listed in the Recreational Vehicle Industry Association's (RVIA) ANSI/NFPA 1192 Handbook for Recreational Vehicle Standards.

System Overview

The Aqua-Hot 125-DN2 is a Hydronic Heating System that can provide heat and hot water on demand using a built-in electric heating element and an external diesel burner.

The Aqua-Hot Heating is a 2-in-1 System

1. Interior heating system: provides quiet, comfortable interior heat and even temperatures.
2. Tank-less hot water system: provides a flow of comfortable hot water.

The Aqua-Hot heating system heats an **ethylene glycol** based antifreeze and distilled water solution that is stored in the Aqua-Hot's boiler tank. This fluid solution must be up to operating temperature before the Aqua-Hot will provide interior heat or hot water. The tank-less hot water system produces approximately 0.8 GPM of hot water.

To get the Aqua-Hot to temperature, turn the electric heating element and/or the external diesel burner to the "ON" position on the Aqua-Hot LCD screen (shown below), or on the RV control panel. It may take up to 20 minutes to get to operating temperature before heat or hot water are available.

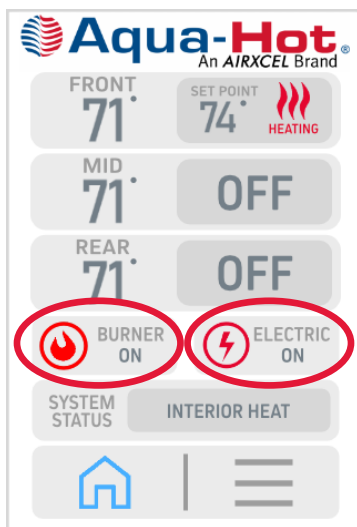

For continuous hot water or heat in colder conditions, it is recommended to utilize the external diesel burner. The electric heating element will provide heat only in mild conditions and provide light duty hot water needs.

Should additional assistance be needed, please contact the Technical Support at 574-AIR-XCEL (574-247-9235), Monday through Friday, between 7:00am and 4:00pm MST.

Important Notes:

- A qualified installer or service technician must perform equipment installation or service. Contact Aqua-Hot for Factory Authorized Service Centers or Certified Technicians located near you at www.aquahot.com/service-help, or call us at 574-AIR-XCEL (574-247-9235).
- Warranty work must be performed by an Aqua-Hot Authorized Service Center.
- Your on-product identity label contains the specifications of your unit. Factory settings may be adjusted by the vehicle manufacturer, confirm final setting with your dealer.
- This heating system has been certified for installation only in recreational vehicles, not certified for use in boats.
- The Aqua-Hot heating system operates independently of the vehicle engine and is connected directly to the electrical system of the vehicle. The diesel burner is only connected directly to the fuel system and the battery of the vehicle.
- Please read this manual and follow instructions to avoid injuries during installation and/or operation.

Heat Priority Option:

The Aqua-Hot comes equipped with the three-way valve (sometimes known as the summer/winter valve). This controls the flow of the antifreeze and water heating solution within the Aqua-Hot to deliver either hot water or interior as priority. Tapping on this element will change the valve's orientation. When this element displays "INT. HEAT", this valve is oriented to provide interior heat by circulating the heating solution throughout the interior heating zone. When the element says "HOT WATER", the valve is oriented so that the heating solution is routed to prioritize hot water.

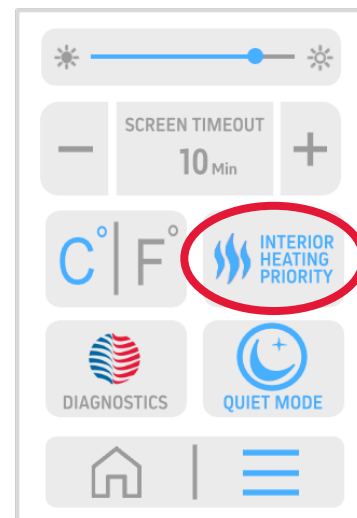



Exhaust system MUST NOT terminate beneath the vehicle and not less than 3 feet from an openable window.

Combustion Air MUST BE supplied from outside the vehicle.

Suitable for water (potable) heating and space heating.

THIS APPLIANCE OPERATES ON BOTH DC AND AC POWER.

USE COPPER CONDUCTORS ONLY!

Use a circuit breaker that cuts power at 20-Amps maximum for over-current protection for the 120-VAC power supply.

Mount the Heater and Unit so that the Access cover can be easily removed for service.

For Detailed Information, reference the Owner's Manual or contact Aqua-Hot Heating Systems Inc. at 574-AIR-XCEL (574-247-9235).

Minimum Service Clearances
 Front - Open Access
 Back - 1 Inches
 Top - 8 Inches
 Sides - 1 Inches

This appliance must be installed in accordance with local codes or, in the absence of local codes, the Standard for Recreational Vehicles, ANSI A119.2/NFPA 1192 or CAN/CSA-Z240 RV



Meets or Exceeds: **UL 307B, UL 174**
CSA/CAN B140.0-03
CAN/CSA-C22.2 No. 110-94

Listing 20L01

Max Tank Pressure	0 PSI
Watts (DC)	84W
Watts (AC)	1500W
Tank Capacity	1.8 gal (Ethylene Glycol)
Volts/Amps	12VDC, 7A
Volts/Amps/Frequency	120VAC, 13.75A, 50/60Hz
Burner Model	5kW Diesel Burner
Burner Fuel	DIESEL
Burner Rating	17,060 BTU/hr

Model Number: AHE-125-DN2
 Serial Number: A125DN-220000
 Burner Serial Number: XXXXXXXXXXXXXXX

7755 Miller Drive • Frederick, CO 80504 • 574-AIR-XCEL • www.aquahot.com

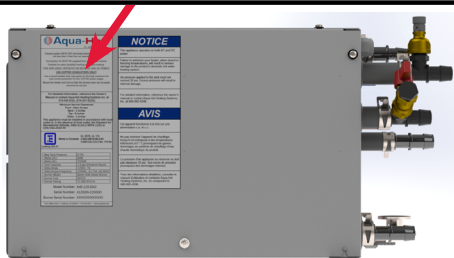

NOTE: This product label is attached to the side of the Aqua-Hot, and provides a ready reference to specifications, test standards, and important safety notices.



Figure 1

System Specifications

Electric Element

Power Consumption1500 W (maximum)
 Voltage 110V AC

DC Power

Power Consumption 57 W (maximum)

Zone Heat Circulation

Pumps 1
 Power Consumption (max).....20W/1.7A
 Voltage 12V DC

Interior Heating

Maximum Heating Zones..... 3
 Cozy 6W/0.5A - 8,000 BTU/hr
 Whisper 4.5W/0.37A - 4,000 BTU/hr
 H.E. II 3W/0.25A - 4,000 BTU/hr

NOTE: Control Panel “Quiet Mode” reduces heat exchanger power consumption by 20%

Domestic Water Heating

Maximum 0.8 GPM

Physical Specifications

Dimensions (US).....17.66”L x 7.50”W x 11.50”H
 Dry Weight45lbs.
 Wet Weight.....59lbs.

All vehicle installations must comply with the requirements listed in the Recreational Vehicle Industry Association’s (RVIA) ANSI/NFPA 1192 Handbook for Recreational Vehicle Standards.

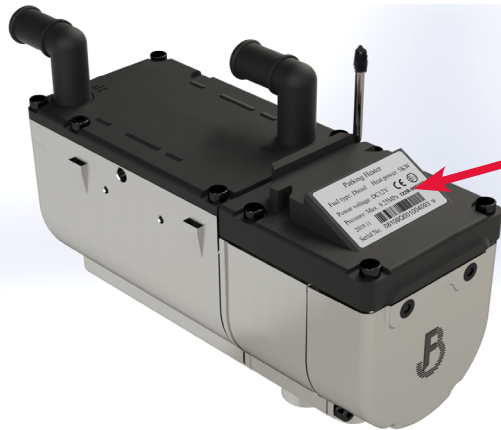

Figure 2

Parking Heater

Fuel type: Diesel Heat power: 5KW

Power voltage: DC12V

Pressure: Max. 0.25MPa **122R-000192**

2019.11

Serial No. 08109Q001004093 w

NOTE: This product label is attached to the top of the burner and provides a ready reference to specifications, test standards, and important safety notices.

System Specifications

Diesel Burner

Heat Flow.....5,188 to 17,060 BTU/hr
 Diesel Fuel Consumption.....0.07 to 0.16 gal/hr
 Coolant Pump.....20W/1.7A
 Operating Pressure (med heat).....36.25 PSI
 Flow Rate (minimum).....36.25 PSI
 Working Altitude 16,000ft

Fuel

Fuel Type.....**DIESEL**
 Fuel Consumption (Low Output)..... 0.07g/h
 Fuel Consumption (High Output)..... 0.16g/h

DC Power

Consumption10 to 37W
 Operating Amp Range.....0.83 to 3.8A

Operating Temperatures

Burner Operation -40 to 176 °F
 Burner Storage.....-40 to 248 °F
 Fuel Pump Operation-40 to 86 °F
 Fuel Pump Storage.....-40 to 194 °F

Physical Specifications

Dimensions.....8.8”L x 3.4”W x 6.9”H
 Weight.....6.3 lbs

TECHNICAL SPECIFICATIONS	
Heating Medium	Ethylene Glycol/Distilled Water
Thermal Power (W)	High Power Operation: 5000W
	Low Power Operation: 2400W
Fuel	DIESEL
Fuel Consumption (gallons per hour)	Low power operation: 0.07 g/h High power operation: 0.16 g/h
Power supply (battery for the engine)	DC12V
Power Consumption (W)	At start <100 W High power operation: 37 W Low power operation: 10 W
Working pressure (MPa)	0.25
Lowest working temperature	-40 °F
Net Weight (heater only)	10.6lbs
Working height (above sea level)	16,405 ft
Weight of Main Heater	6.3lbs

All vehicle installations must comply with the requirements listed in the Recreational Vehicle Industry Association’s (RVIA) ANSI/NFPA 1192 Handbook for Recreational Vehicle Standards.

- | Aqua-Hot 125-DN2 | |
|------------------|--|
| 1. | Tempering Valve |
| 2. | Fluid Circulation Pump |
| 3. | Aqua-Hot Controller |
| 4. | Antifreeze and Water Heating Solution Tank |
| 5. | AC Electric Element |
| 6. | AC Activation Relay |
| 7. | Plate-to-plate Heat Exchanger |
| 8. | Three-Way Valve |
| 9. | Zone Air-Bleed Valve |
| 10. | Fluid Expansion Port (to overflow bottle) |
| 11. | Zone Return |
| 12. | Fluid Fill Port |
| 13. | Zone Supply |
| 14. | Service Panel |
| 15. | External Diesel Burner Supply |
| 16. | External Diesel Burner Return |
| 17. | Domestic Cold-Water Inlet |
| 18. | Domestic Hot-Water Outlet |
| 19. | Domestic Low Point Drain |
| 20. | Cabinet Drain |

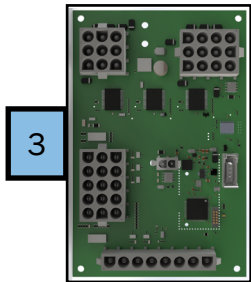

Figure 4

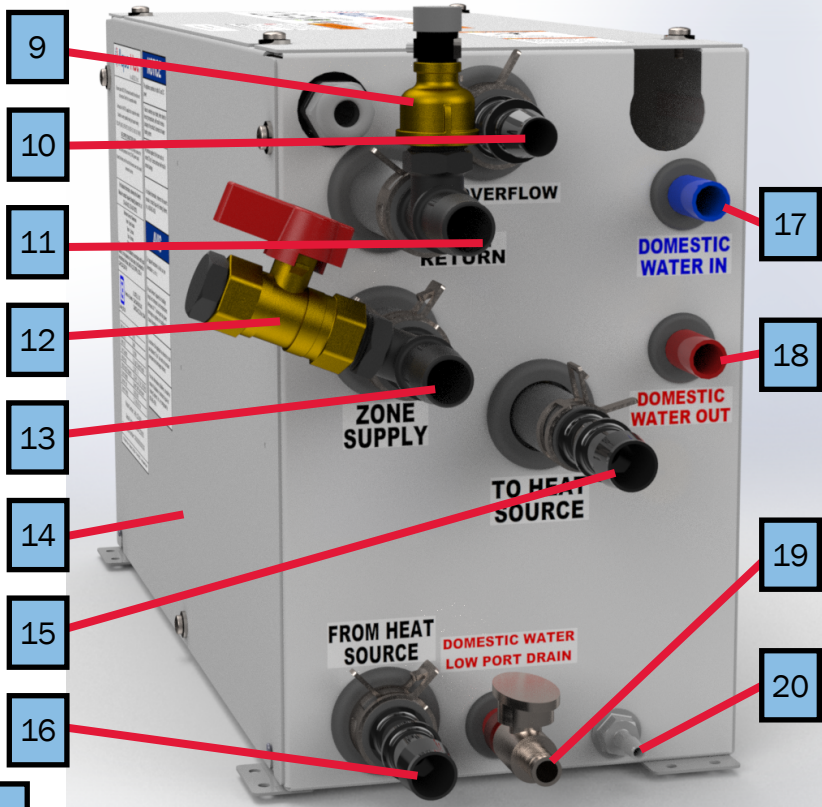

Figure 5

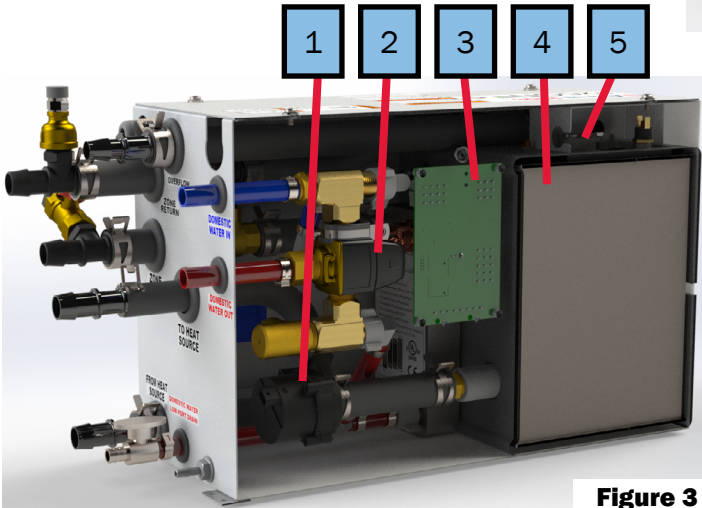

Figure 3

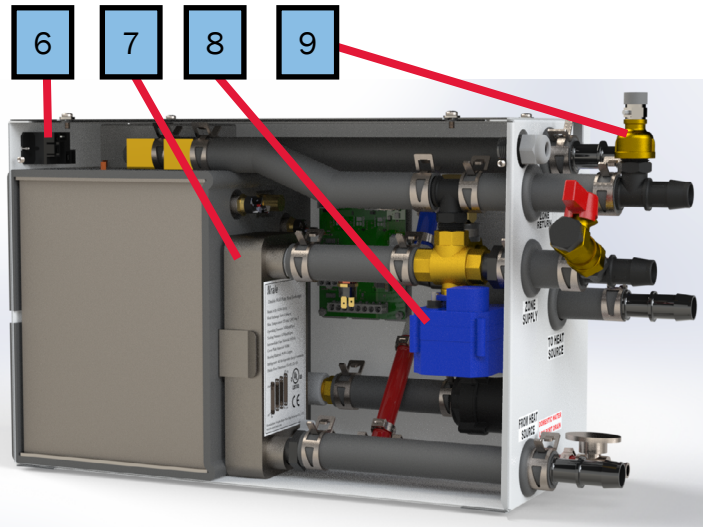

Figure 6

NOTE: The side panel in the view above has been made transparent to aid in the explanation of the heater. DO NOT remove this side panel. Doing so risks irreparable damage to the Aqua-Hot. Only remove the service panel for service.



Figure 7

Diesel Burner	
1. Combustion Air Fan	12. Fuel Pipe
2. Burner Outer Casing	13. Coolant Pump
3. Burner Inner Casing	14. Fuse
4. Combustion Chamber	15. Main Wire Harness Connector
5. Glow Plug	16. Fuel Pump
6. Flame Sensor	17. Exhaust Pipe
7. Temperature sensor	18. Coolant outlet Pipe
8. Over-Heat Sensor	19. Coolant Inlet Pipe
9. Burner Controller	20. Burner
10. Air Inlet Pipe	21. Diesel Fuel Filter
11. Muffler	



Figure 8

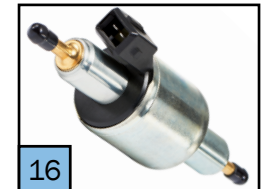

Figure 9

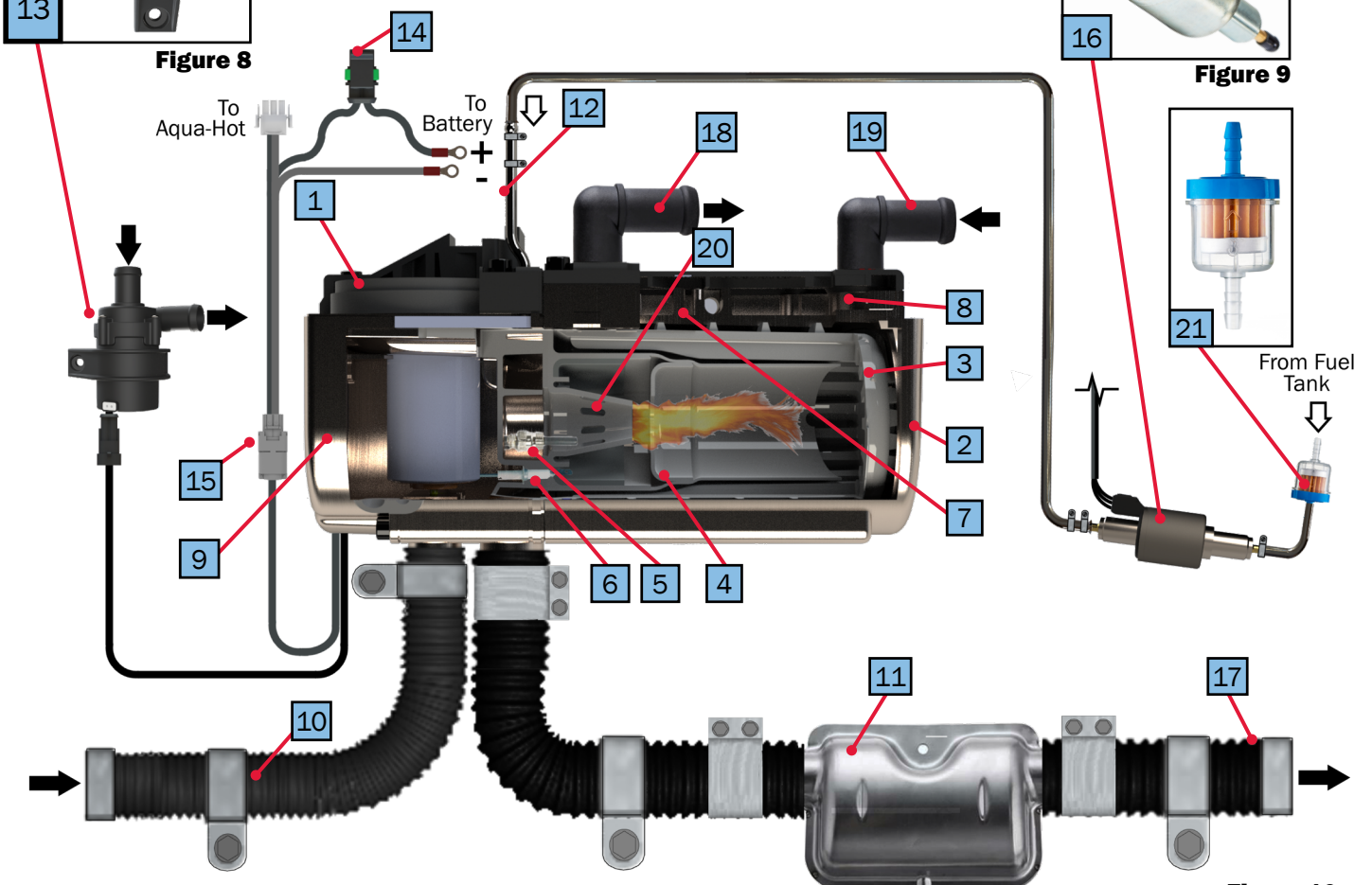

Figure 10

Installing the Aqua-Hot

Install the Aqua-Hot in a compartment which protects the unit and allows service access to the top and front panel of the Aqua-Hot.

1. Reference the following illustrations below for mounting information.
2. Secure the Aqua-Hot to the RV floor using appropriate mounting hardware to suit flooring material and tolerances.
3. The Aqua-Hot is best placed where easy access to the top and front is guaranteed for service.

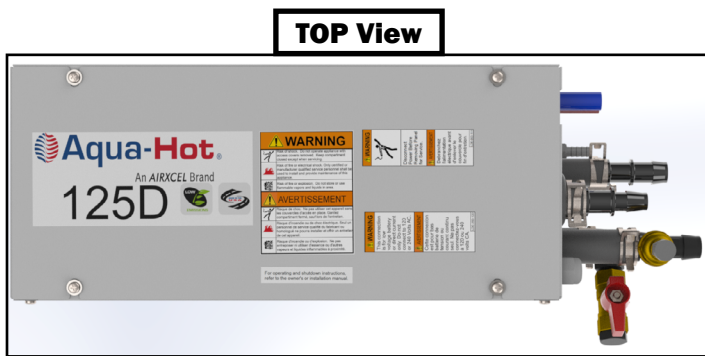

Figure 11

Support and Clearances

Make the following considerations when supporting the Aqua-Hot to ensure its most optimal operation and location. Dimensions for the mounting tabs are shown below.

- Ensure that the floor of the mounting location can support at least 70lbs.
- Use a #10 screw (5mm) to secure the Aqua-Hot in place on the RV floor. Use at least 1 screw per mounting tab (3 tabs).
- The best place for the Aqua-Hot heating system is in a cabinet or storage space, making sure there is ample space to remove the service panels on the top and side.

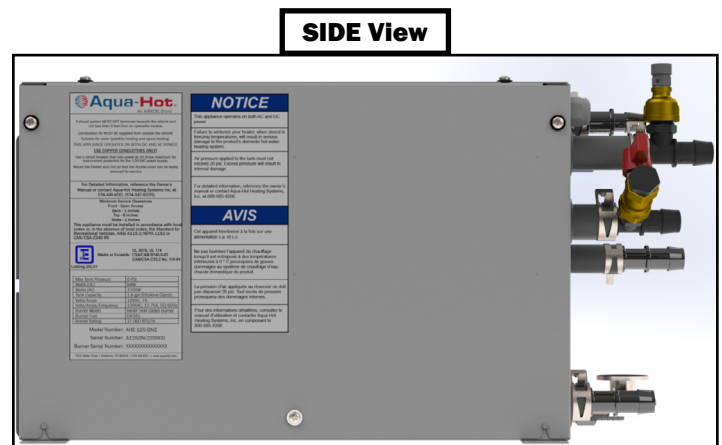

Figure 12

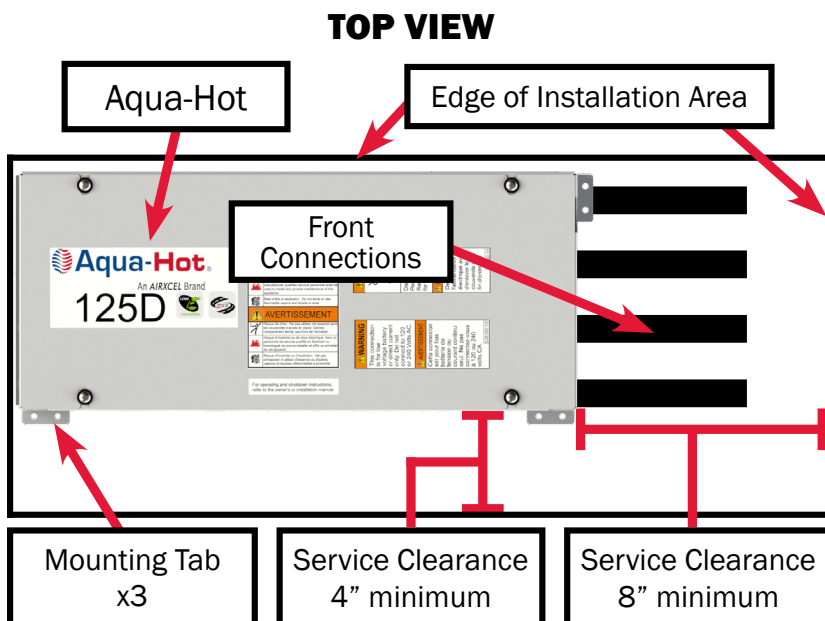

Figure 13

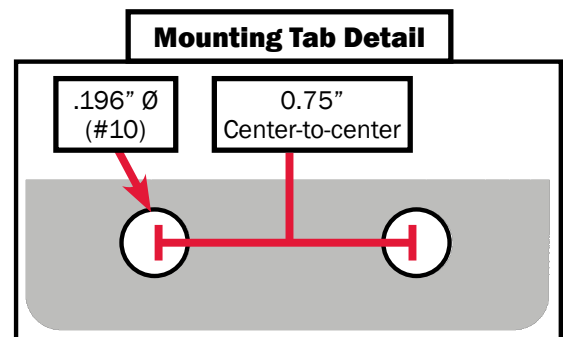

Figure 14

Installation of the Expansion Bottle

The fluid expansion bottle is integral to the operation of the Aqua-Hot. It provides an area for hot, expanded fluid to empty into, and also protects the Aqua-Hot from low-fluid, which could lead to catastrophic damage of the Aqua-Hot.

NOTE: Before securing the expansion bottle to the side of the Aqua-Hot or its mounting location, the boiler tank must be filled with the heating solution. The expansion bottle must be higher than the unit for this to happen to avoid air locks. See “Filling the Aqua-Hot” on page 37 for more information.

Follow the directions in this section to correctly install the fluid expansion bottle.

Installation Procedure:

1. Place the expansion bottle in position on the side of the Aqua-Hot or other mounting location in the RV.
2. Secure the expansion bottle using either self-tapping screws driven into the dimples in the area of the Aqua-Hot shown in below, or mounting hardware specific to the

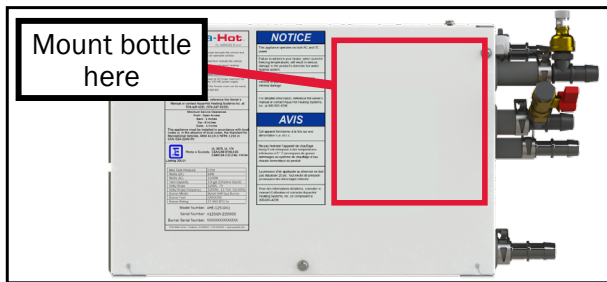

Figure 15

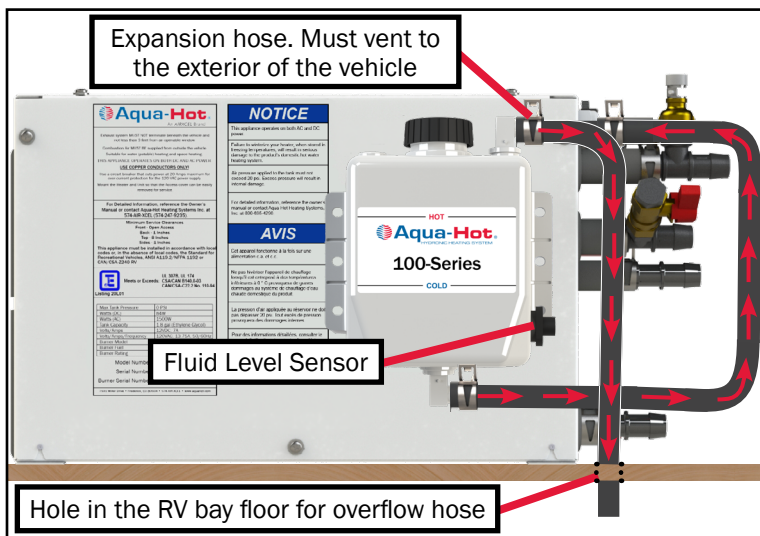

Figure 16

NOTE: Avoid any bends or dips in the overflow tubing from the Aqua-Hot. Air can become trapped in these bends and will prevent excess antifreeze and water heating solution from depositing properly in the expansion bottle.

mounting location in the RV. Please only use the length of hose provided, or less, if the bottle is not mounted to the side of the Aqua-Hot. Additionally, there should be a gradual rise from the Aqua-Hot to the expansion bottle if it is not mounted to the Aqua-Hot.

3. Drill a hole in the floor of the RV to allow the overflow tube to vent to the exterior of the vehicle (Figure 16).
4. Cut the hoses to length if necessary.
5. Place a hose which runs from the lower fitting of the expansion bottle to the expansion bottle connection shown in Figure 17. Secure this hose in place with 2 constant tension hose clamps.
6. Place the overflow hose so that it connects to the upper fitting of the expansion bottle, and exits through the hole drilled through the RV floor in step 3 (Figure 16). Secure this hose to the upper fitting with a constant tension hose clamp.
7. Locate the wires of the expansion bottle and connect them to wires J43 and J44 on the wiring harness.

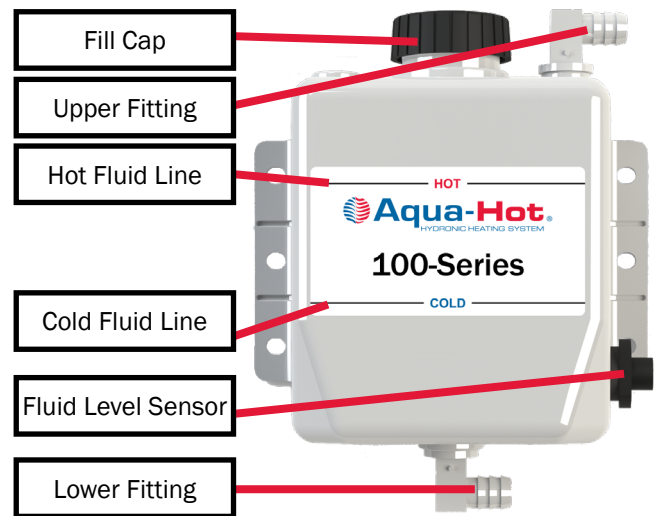

Figure 17

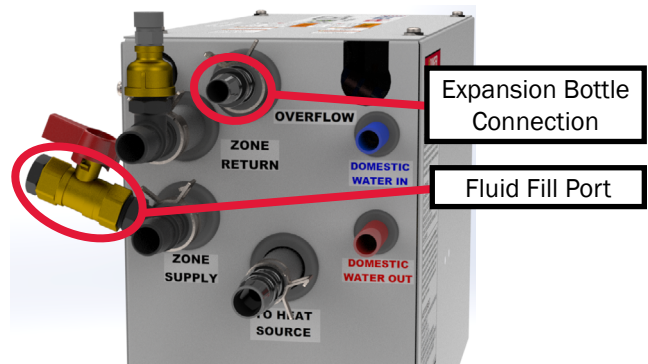

Figure 18

Mounting the Burner to the Vehicle

Install the external diesel burner in a location separate from the living spaces that protects the unit, and also allows service access to the burner.

NOTE: The burner must be mounted in a vertical orientation (with the exhaust and intake ports facing downwards) **ONLY**.

- Reference the illustrations below for mounting information.
- The burner is best placed in a location where it can be easily accessed for service and maintenance.
- The burner must **not** be mounted higher than the expansion bottle.
- The bracket must be secured to the vehicle with at least 4 M6 screws.

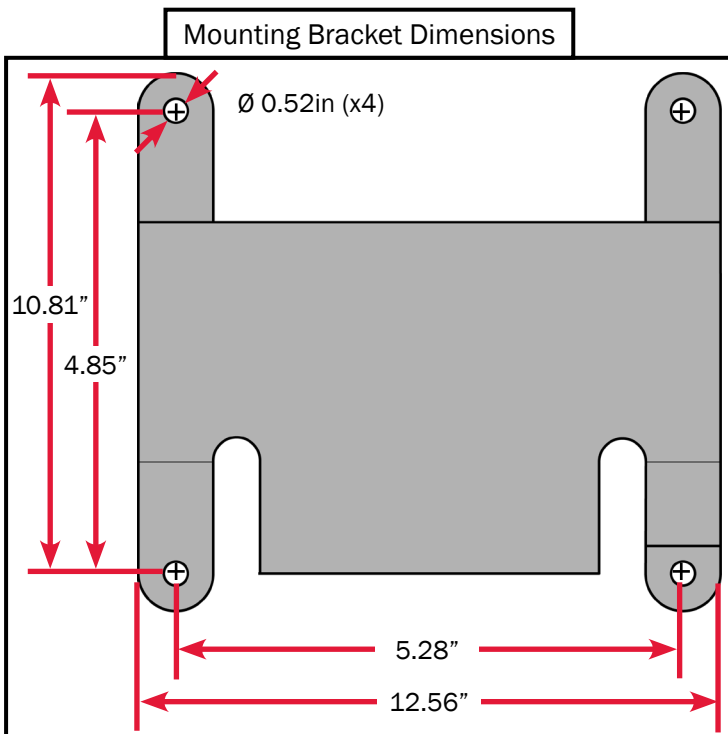

Figure 19

- Fasten the burner bracket firmly, the 4 corners should be lined with rubber shock absorbers. The burner must be fastened on the bracket with (4) M6 bolts (see Figure 20).
- If mounting to the frame rail, use (4) M6 bolts. Drill (4) M6 holes where the burner will be mounted, and fasten the bracket to the vehicle with (4) M6 bolts.
- Secure the burner to the bracket using appropriate mounting hardware, M6*95 bolts torqued to 6 lb-ft.

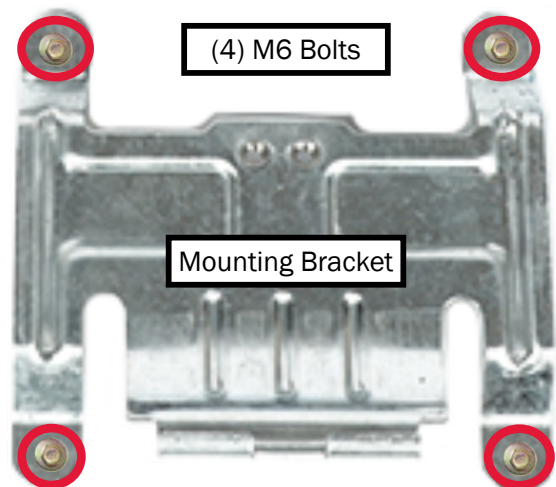

Figure 20



Figure 21



Figure 22



CAUTION

Before drilling holes in the vehicle, consult the manufacturer for recommendations and limitations. Do NOT weld to the vehicle frame.

Combustion Air System

The combustion air should not be supplied from living areas. The air intake opening must not point in the direction of travel. It also should be free from potential clogs from snow, debris, or water.

NOTE: The air intake tube cannot be installed downward. A water drain hole (Ø 2-5) is to be made at the lowest point. The tube should be installed in a position that stays as cool as possible and protected from splashing water.

- Installation of air intake & exhaust system is shown below.
- There is no air pressure difference between the exhaust outlet or combustion air inlet.
- The combustion air intake must be positioned in a way that the intake will not terminate within the vehicle interior or near the burner's exhaust pipe.
- The air intake tube must be located in a cool place.
- The combustion air intake must be positioned high enough so splashing water cannot come into contact.
- It must be positioned as to not become clogged with dirt or debris.
- It should not be able to draw in exhaust fumes.
- It must be positioned away from the face of travel.
- If operation of the system is expected at altitudes greater than 6,000 feet, remove the air inlet filter and route the inlet hose in such a way to protect it from water, dirt and debris ingestion.

The combustion air intake may be installed in the same compartment as the vehicle's fuel tank, but the air intake must come from the exterior. The exhaust must be routed to the exterior and any holes must be splash-proof.

Refer to the "Internal Combustion Engine Exhaust and Vehicle Wall Openings" in RVIA's ANSI/NFPA 1192 Handbook for Recreational Vehicle Standards, as well as the National Fire Protection Association's (NFPA) 1192 Standard on Recreational Vehicles for relevant information.

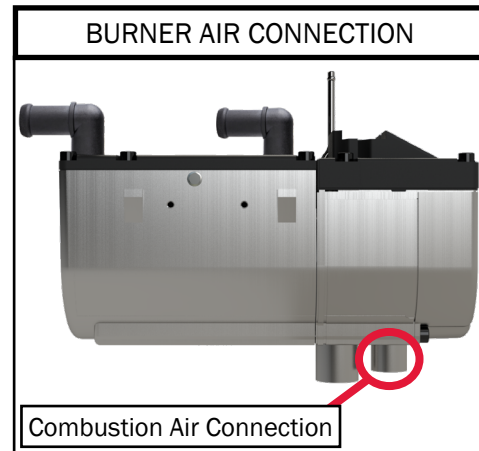

Figure 23

NOTE: Should this particular application require modification, please contact Aqua-Hot Heating Systems at 574-AIR-XCEL (574-274-9235) for further assistance.

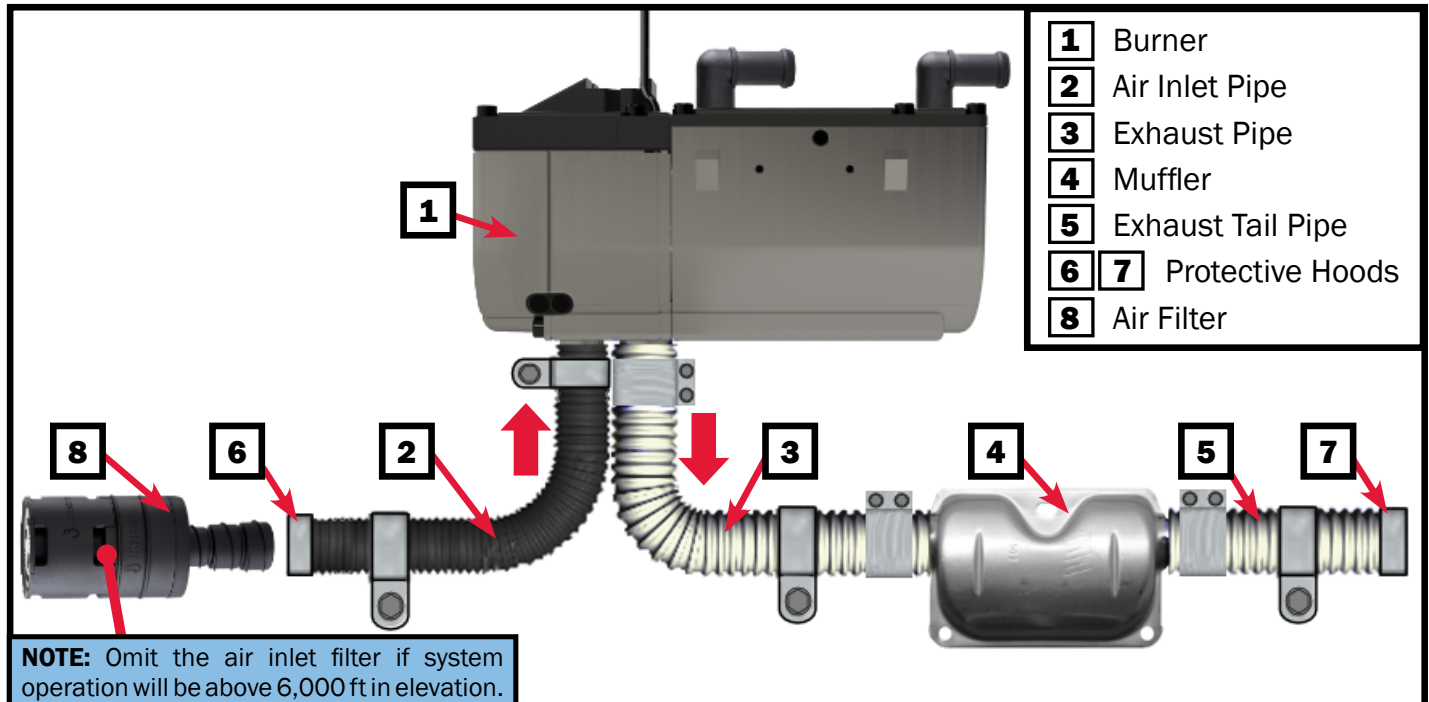

Figure 24

Exhaust System



WARNING

The direction of the exhaust outlet must be directed away from any heat sensitive or highly flammable parts. Failure to do so will result in a fire. Exhaust cannot be routed through the interior of the vehicle, only the exterior. Failure to do so can cause exhaust gas to leak inside the vehicle causing illness and/or death.

The specifications and requirements must be followed carefully. Failure to follow instructions may result in improper and unsafe operation of the 125-DN2 and burner. Please comply with all applicable legal requirements.

- Do not direct exhaust downward, as fire may result when the vehicle is near dry, grassy areas.
- Exhaust must not terminate beneath the vehicle or beneath a window or vent.
- Ensure that the exhaust pipe is routed away from any awnings or slide-out areas.
- Position the exhaust pipe away and towards the rear of the vehicle so the fumes naturally move away while the vehicle is in motion and cannot permeate the interior of the RV.

Instructions

The exhaust pipe, with an inside diameter of 0.94in (24mm), can be routed with several bends, total not to exceed 270°, and a minimum bending radius of 2in (50mm). The total length must not exceed 2.3' (700mm).

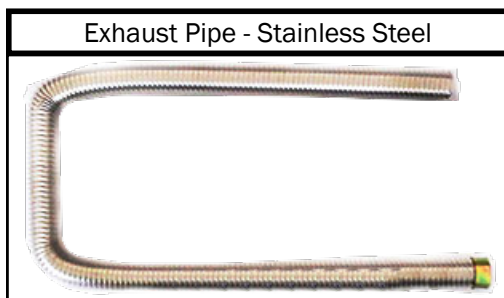

Figure 25

NOTE: Exhaust parts are at high temperatures when the heater is operating. They shall be installed far away from plastic parts and wires of the vehicle to avoid damage. The air inlet pipe and exhaust pipe can freeze easily in working conditions and should be checked regularly for obstructions.

The exhaust pipe should be cut to form two sections: the exhaust pipe and exhaust tail-pipe. The muffler will be installed in the middle and fixed with the muffler holder. It may not be fastened to temperature-sensitive vehicle parts. There should be at least 0.8in (20mm) between the muffler, or exhaust, and temperature-sensitive parts. Thermal insulation may be used on the exhaust pipe.

It is recommended to route the exhaust pipe in a downhill slope. If it is not possible, drill drain holes (Ø2-5mm) at the lowest points.

The exhaust pipe opening should not extrude out past the vehicle. The opening should prevent intake from the air inlet pipe. The opening should be away from the direction of travel.

Rigid, stainless steel with a minimum wall thickness of 0.04in (1mm) or flexible piping of the same material may only be used as the exhaust pipe. The exhaust pipe is secured to the muffler using supplied exhaust clamps.

Exhaust Outlet Requirements

- The exhaust gas must be able to flow freely.
- The exhaust outlet must not be clogged with snow or debris.
- Exhaust outlet must not face in the direction of travel.
- Exhaust fumes may not enter the interior of the vehicle via windows, doors, or other openings.
- The exhaust gas cannot be drawn in for the combustion air.
- The exhaust opening may not be close to the ground.
- If the vehicle has an under-body, the exhaust opening must extend at least 3/8 in (10mm) past the vehicle.
- The exhaust line must be secured with clamps (2 each) in the proper locations.

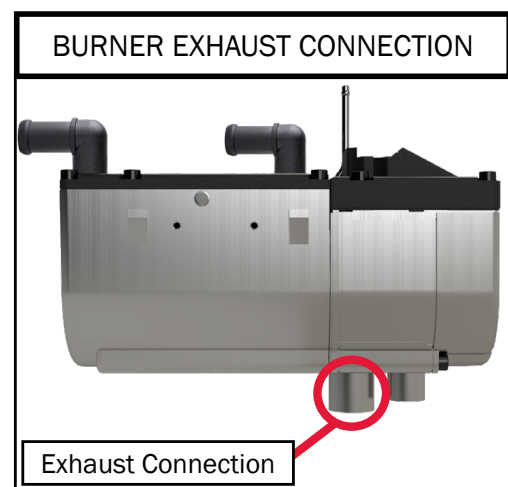

Figure 26

Diesel Burner Wire Harness

The diesel burner and connectors will need to be properly installed. Please note that the connectors will not fit in incorrect positions.

The connectors and information are shown below.

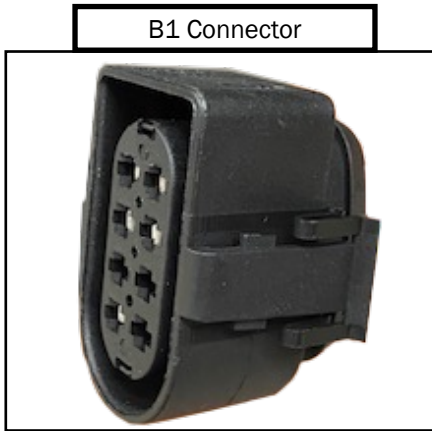

Figure 27

B1 Plug:

The B1 plug is the connector to the diesel burner.

Manufacturer	Part No.	Common Name
TE Connectivity	2109441-4	Socket Housing
TE Connectivity	1-968857-1	Terminal
TE Connectivity	828905-1	Wire Seal
TE Connectivity	828922-1	Plug, Blue (Pins 1, 2, & 5)

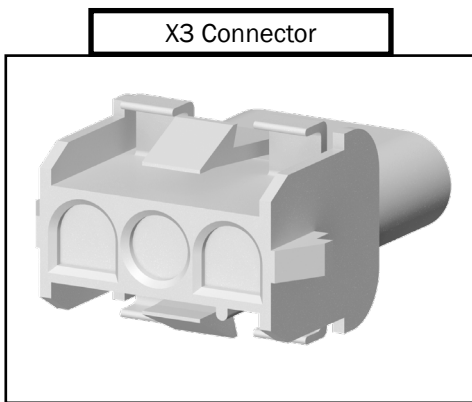

Figure 28

X3 Plug:

The X3 plug is the connector for the Aqua-Hot to the burner.

Manufacturer	Part No.	Common Name
TE Connectivity	1586849-1	3-Pin Mate-N-Lok Receptacle Connector
TE Connectivity	350690-2	Pin
TE Connectivity	350551-6	Socket



Figure 29

B3 Plug:

The B3 plug is the connector for the fuel pump to the diesel burner.

Manufacturer	Part No.	Common Name
TE Connectivity	282104-1	Socket Housing
TE Connectivity	282404-1	Terminal
TE Connectivity	281934-4	Wire Seal

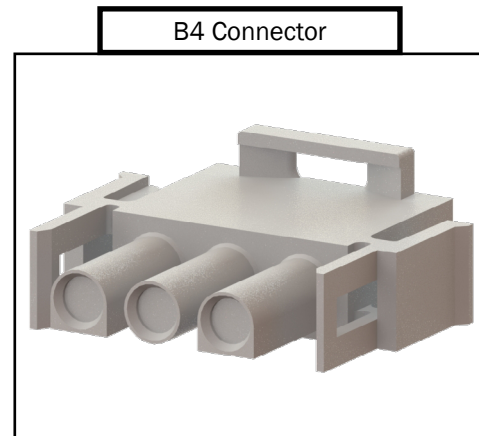

Figure 30

B4 Plug:

The B4 plug is the connector for the burner to the Aqua-Hot.

Manufacturer	Part No.	Common Name
TE Connectivity	350766-4	3-Pin Mate-N-Lok Receptacle Connector
TE Connectivity	350690-2	Pin
TE Connectivity	350551-6	Socket

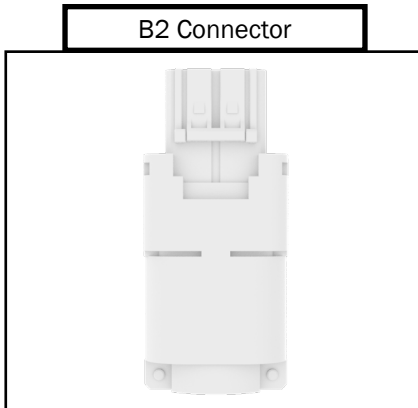

Figure 31

B2 Plug:

The B2 plug is the connector for the converter.

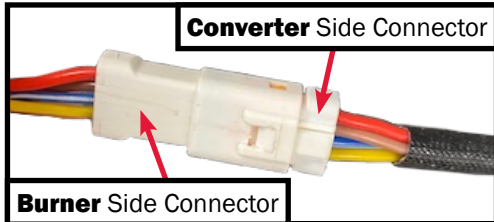

Figure 32

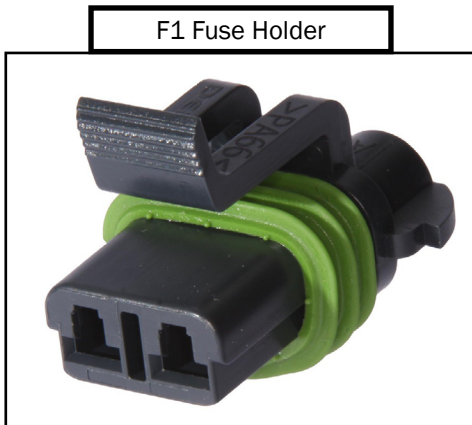

Figure 33

F1 Fuse Holder:

The F1 Fuse holder, with 20A fuse.

Manufacturer	Part No.	Common Name
Packard	15300027	Female Connector
Aptiv	12129493	Terminal
Aptiv	15300014	Lock
Aptiv	15324983	Seal
Aptiv	ES10	Cover
Packard	-	20Amp Fuse (included)

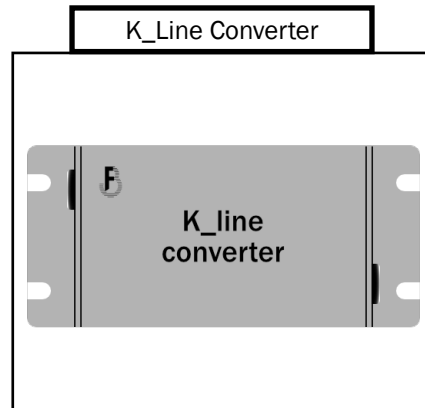

Figure 34

K_Line Converter:

The K_line converter connects the burner to the Aqua-Hot. The LEDs show the operation of the converter. They can be found on the side of the converter. Reference the images below for more information.

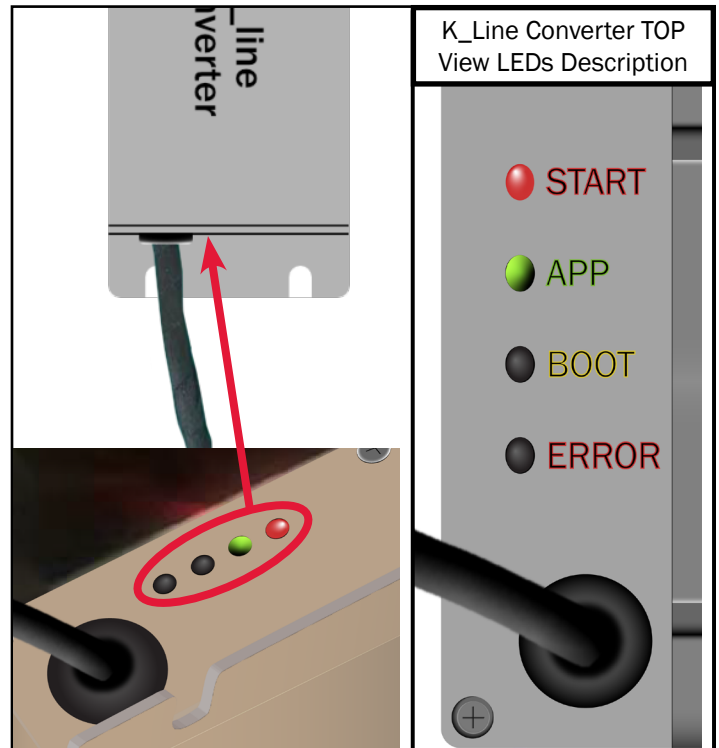

Figure 35

NOTE: It is recommended to mount the K_Line Converter using double-sided Velcro on the Aqua-Hot cabinet, either on the top, in-between ports, or on either side of the cabinet where space allows.

BURNER HARNESS DIAGRAM

NOTE: It is recommended to mount the K_Line Converter using double-sided Velcro on the Aqua-Hot cabinet, either on the top, in-between ports, or on either side of the cabinet where space allows.

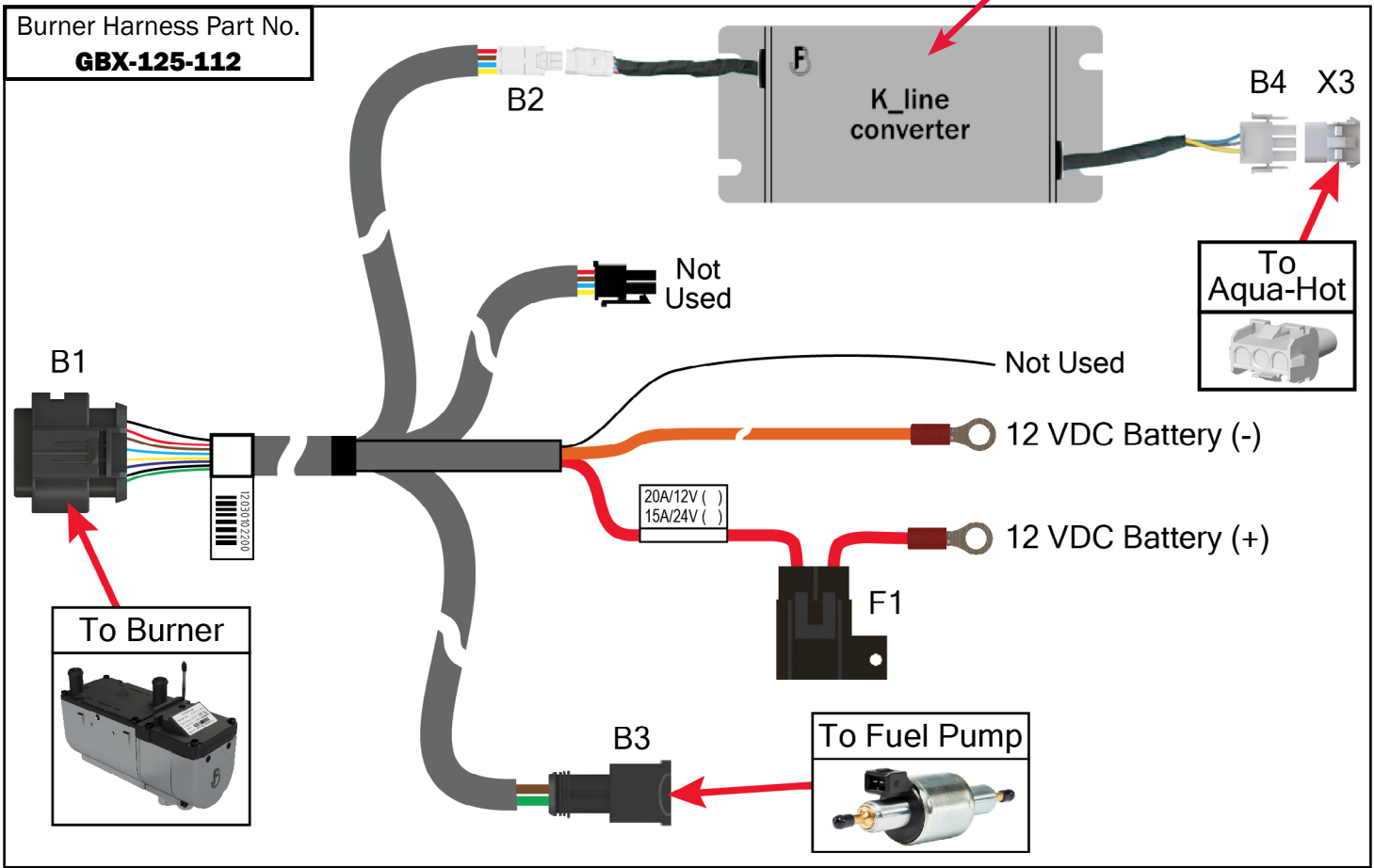

Figure 36

Connecting the Burner to the Aqua-Hot

These instructions will cover the installation and power connections for the diesel burner to the 125-DN2.

Installation Instructions

1. Mock-up the locations for the diesel burner and the Aqua-Hot within the RV to ensure that there is adequate room for access of the burner and the Aqua-Hot.
2. Verify the Aqua-Hot is secured in place.
3. Position and secure the diesel burner in place.
4. Mount the K-Line Converter using double-sided Velcro on the Aqua-Hot cabinet, either on the top, in-between ports, or on either side of the cabinet where space allows.
5. Reference the image below for the burner for the supply and return ports for the antifreeze and water heating solution.
8. Locate the Aqua-Hot wire harness (Part No. ELE-125-100) and the burner harness (Part No. GBX-125-112). The connectors for the Aqua-Hot harness and the burner harness are shown below. Reference pages 14-15 for more information on the burner connectors and page 16 for the full burner harness diagram.

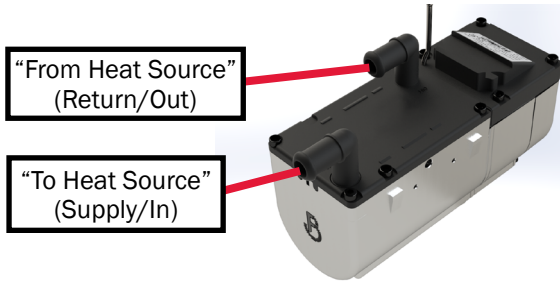

Figure 37

6. Connect the diesel burner return and supply hoses to the Aqua-Hot as indicated by the image below.

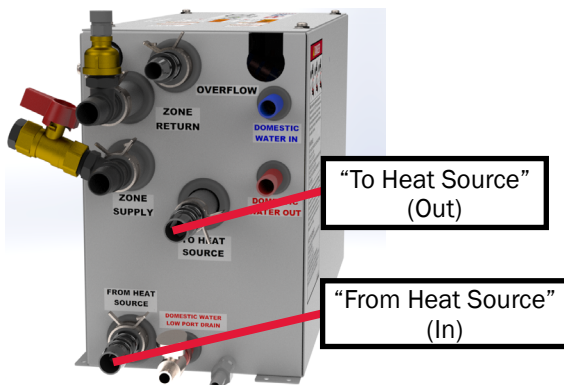

Figure 38

7. Secure the plumbing to the burner with constant tension hose clamps.



Figure 39

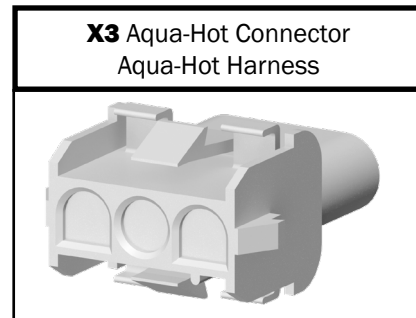

Figure 40

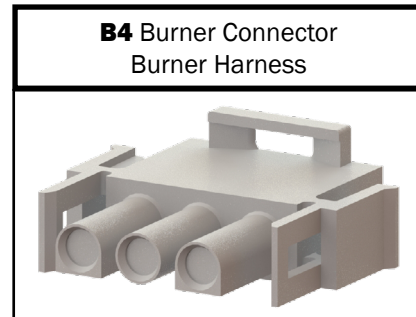

Figure 41

9. To connect the burner to the Aqua-Hot, simply attach the Aqua-Hot plug (X3) to the burner plug (B4). The table below shows more detail for what the pins are for.

Pin Number	Description
1	ON/OFF
2	Ground
3	Input Burner Status

10. Organize and tidy the wires that lead to the burner and the Aqua-Hot to protect them from damage and short circuits.

Burner Connections

Please reference the instructions below and the image in Figure 42.

- The circulation pump inlet should be below the coolant outlet port to eliminate air in the line when installing.
- Verify the inlet and outlet ports on the burner prior to installing hoses. The correct direction of the coolant flow must be determined.
- Secure hose connections using hose clamps, tightened with a torque of 40 lb-in (4.5 Nm).

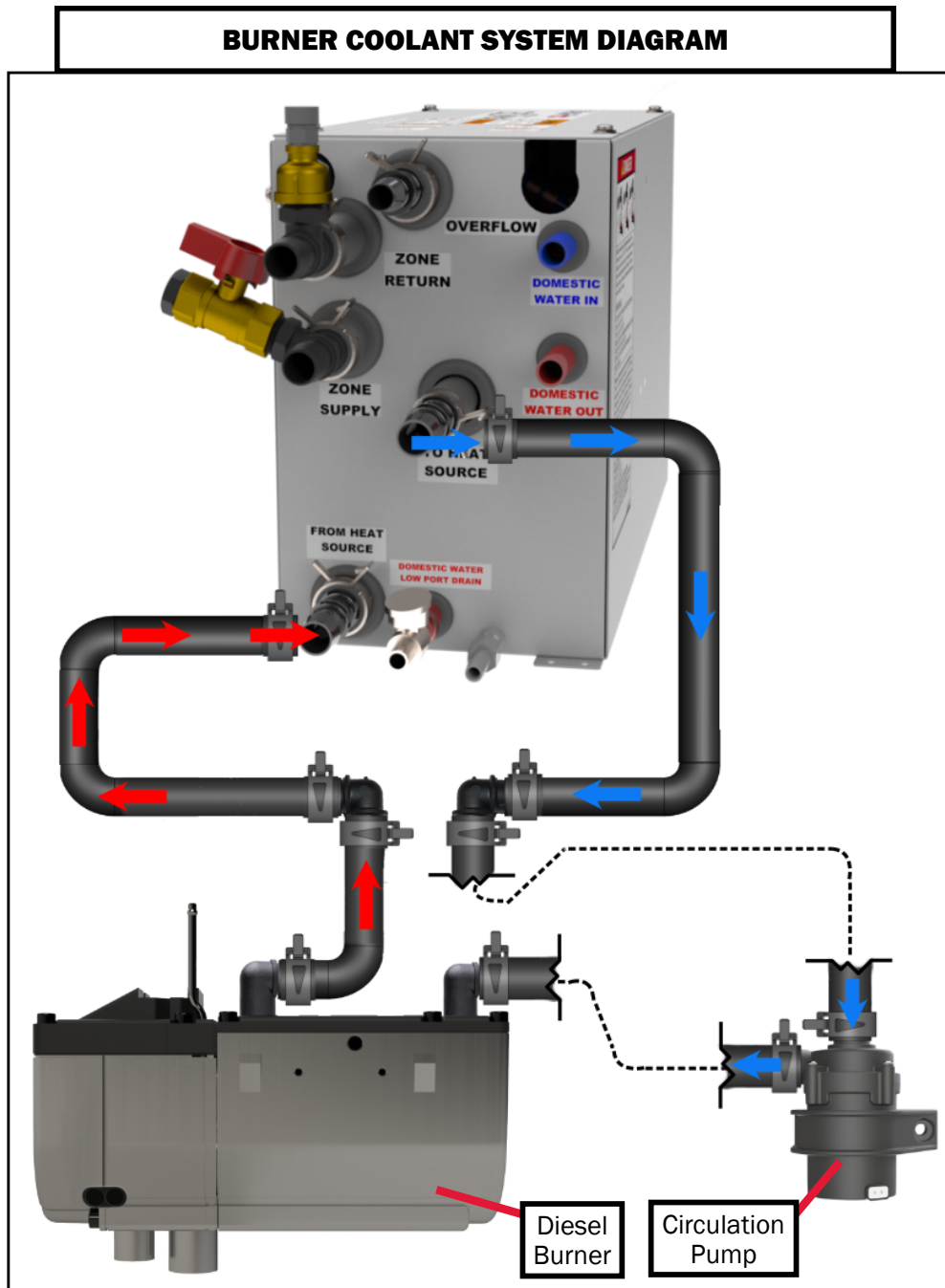

Figure 42

Plumbing Requirements

The plumbing lines are how the fluid is transferred from the Aqua-Hot to the burner and back to the Aqua-Hot to transport heat to domestic water and to the interior of the RV.

Properly installing the coolant hoses to the Aqua-Hot from the burner are integral to the correct and safe operation of the heating system.

Reference the requirements below to ensure the plumbing lines are properly installed.

- Hoses used in this installation must comply with SAE 20 R3 specifications.
- The plumbing hoses should avoid any bends or dips as these can cause excess air in the lines, not allowing the flow of coolant to properly flow.
- The hose clamps must be tightened with a torque of 40 lb-in (4.5 Nm).
- Reference the plumbing diagram below for an example of how the burner should be plumbed with the 125-DN2.

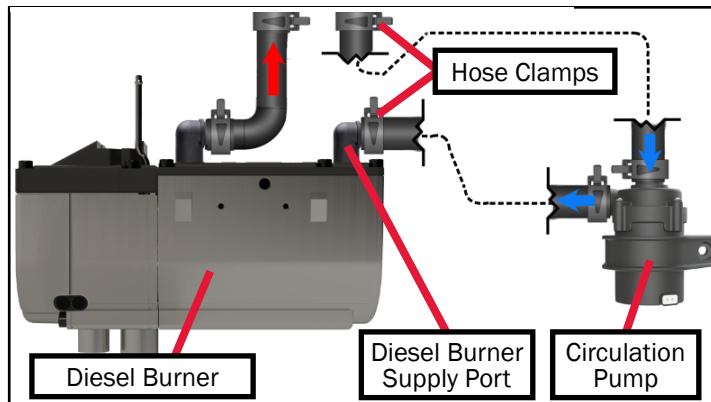

Figure 43

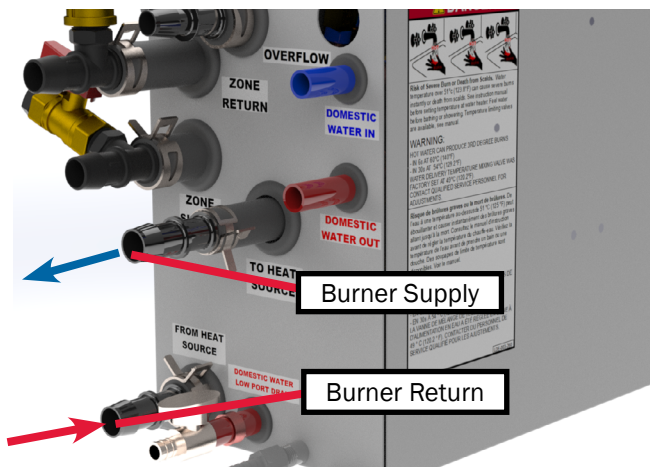

Figure 44

NOTE: This diagram below is simply a reference to show the layout and flow of the plumbing to and from the heaters. Placement may vary depending on the RV.

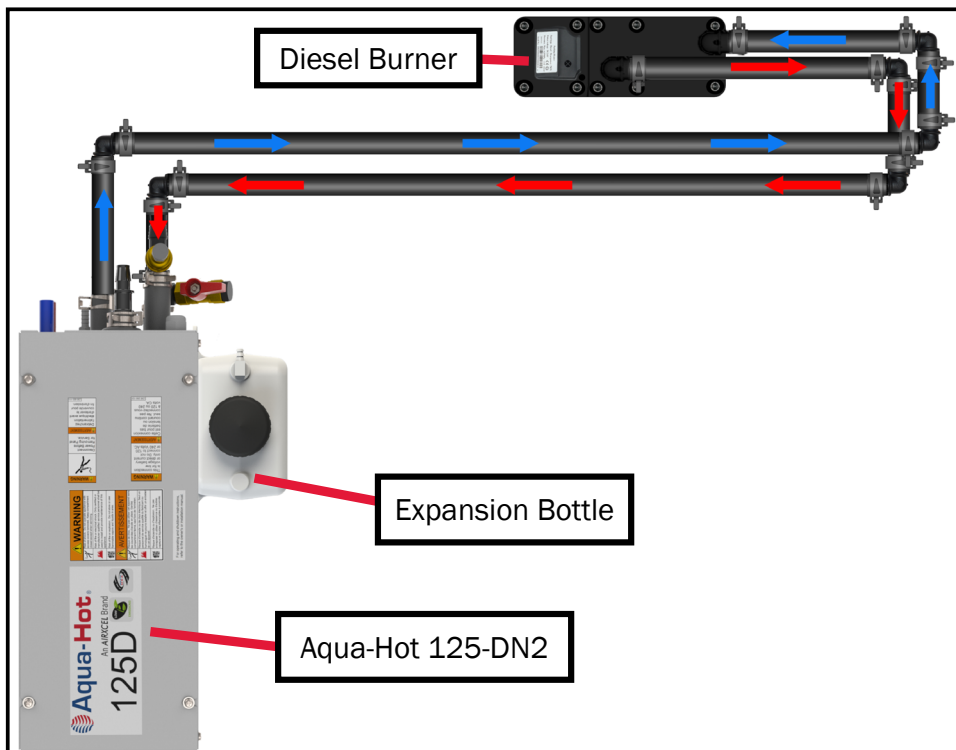

Figure 45

Wiring the Aqua-Hot

This section will introduce the basic considerations, practices, and information necessary to wire the Aqua-Hot to any relevant RV-side systems. The following section will outline the basic pin out information for the two RV-side plugs.

J7 Plug

The J7 plug is responsible for managing all zone fan power connections, and boost pump supply and return.

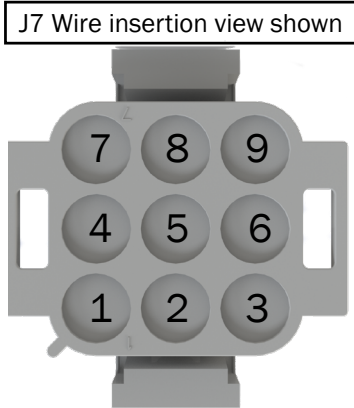

Figure 46

J8 Plug

The J8 plug is meant to handle the zone thermostats and House Power Sense functionality. House power sense functionality will be described in detail later in this manual.

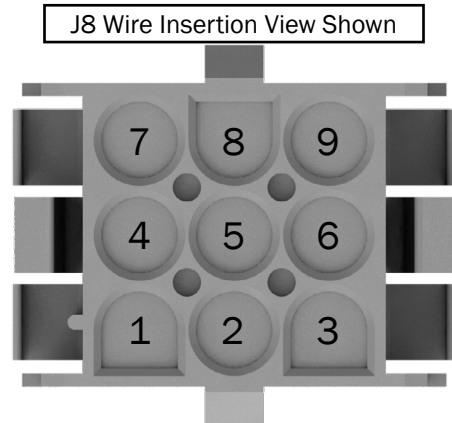

Figure 47

Manufacturer	Part No.	Common Name
TE Connectivity	1-480706-0	9-Position Mate-N-Lock
TE Connectivity	350550-1	Mate-N-Lock Power Contacts

Once all the required hardware has been acquired, wire the J7 plug according to the table below. J7-9 is not used.

Pin Number	Function	Connect To
J7-1	Fan 1 Output	Zone 1 Fans (+)
J7-2	Fan 2 Output	Zone 2 Fans (+)
J7-3	Fan 3 Output	Zone 3 Fans (+)
J7-4	Fan 1 Ground	Zone 1 Fans (-)
J7-5	Fan 2 Ground	Zone 2 Fans (-)
J7-6	Fan 3 Ground	Zone 3 Fans (-)
J7-7	Boost Pump Output	Boost Pump +
J7-8	Boost Pump Ground	Boost Pump -
J7-9	Input Burner Status	

Manufacturer	Part No.	Common Name
TE Connectivity	350782-1	9 Position Mate-N-Lock
TE Connectivity	350550-1	Mate-N-Lock Power Contacts

Once the required hardware has been acquired, wire the J8 plug according to the table below.

Pin #	Function	Connect To
J8-1	Zone 1 Input from Thermostat/Thermistor	Zone 1 Thermostat
J8-2	Zone 1 Output from Thermostat/Thermistor	Zone 1 Thermostat
J8-3	UNUSED/SPARE	UNUSED/SPARE
J8-4	Zone 2 Input from Thermostat/Thermistor	Zone 2 Thermostat
J8-5	Zone 2 Output from Thermostat/Thermistor	Zone 2 Thermostat
J8-6	UNUSED/SPARE	UNUSED/SPARE
J8-7	Zone 3 Input from Thermostat/Thermistor	Zone 3 Thermostat
J8-8	Zone 3 Output from Thermostat/Thermistor	Zone 3 Thermostat
J8-9	House Power Sense	12V DC Power (+)

WARNING

Installation must be performed by a professional installer or technician as per national/local regulations. Improper installation can cause property damage, injury, or death.

Wiring the Aqua-Hot (continued)

The following section will outline the basic pin out information for the RV-C system of the RV.

J3 Plug

The J3 plug connects to the on-board RV-C system of the RV. It is a 4-pin connector with self contained power pins. See the diagram below for the crimping information for the J3 plug. Crimp these parts together using pliers.

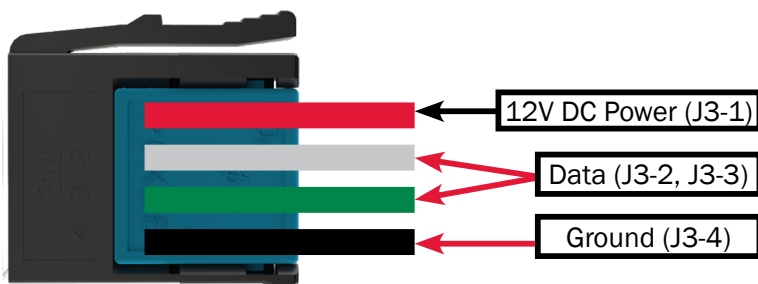

Figure 48

Manufacturer	Part No.	Description
3M	37401-2165-000 FL 100	4-Position MALE Plug
3M	37104-2165-000 FL 100	4-Position FEMALE Receptacle
General Cable	E2104S.41.02	4COND 22AWG WHT SHLD Cable

The parts listed above can be purchased from any major electronics retailer. Only the parts listed above are approved for use in the Aqua-Hot.

Pin Number	Description
J3-1	12V DC Power
J3-2	Data
J3-3	Data
J3-4	Ground

House Power Sense

The Aqua-Hot Controller contains within it a fail-safe functionality known as House Power Sense. This functionality serves as a live signal to the Aqua-Hot allowing it to continue operating. If power is lost to the on-board RV-C network or other on-board control systems, the Controller is signaled to shut down operation until a 12V DC power signal is returned to the unit.

Wiring for House Power Sense

In order for the Aqua-Hot to function correctly and to maintain the fail-safe nature of the House Power Sense, supply 12V DC power to either the J8-9 pin OR to the J3-1 pin. Do **NOT** supply power to both of these pins.

Wiring for Multi-Plex Systems

When wiring for Multi-Plex Systems, route a power wire from a power connection on the RV-C system to the Aqua-Hot's J3-1 pin (that is, plug J3, pin 1). The House Power Sense will not function correctly if 12V DC power is not supplied from a device on the RV-C network.

Routing the wire from the RV-C network (or from an accessory on the RV-C network) ensures that if the RV-C network goes off-line (but the vehicle remains otherwise powered), the Aqua-Hot will not continue to operate unabated.

There are two ways to wire the House Power Sense for use with a Multi-Plex network; typical wiring case and a special wiring case.

Typical

The typical use case in wiring the House Power Sense requires a constant 12V DC signal on plug J3-1 for the House Power Sense. Plug J3 is the 4-position RV-C plug. This is the easiest way to implement House Power Sense on vehicles with on-board Multi-Plex systems.

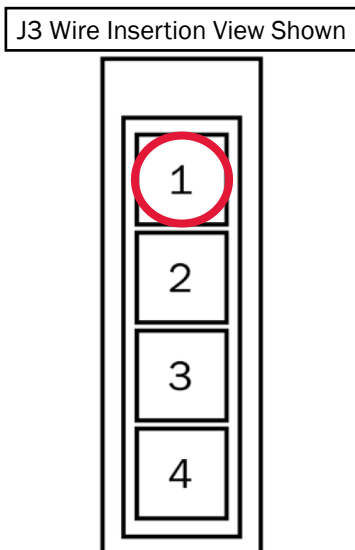

Figure 49

Special

If for some reason pin J3-1 cannot be supplied with power, supply 12V DC power to the J8-9 pin.

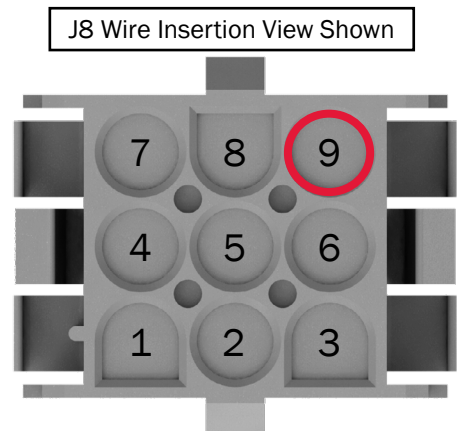

Figure 50

Connecting the 125-DN2 to 12V DC Power

CAUTION

DO NOT connect 12V DC power to the Aqua-Hot if the vehicle requires welding. Electrical welding will cause serious, irreversible damage to the Aqua-Hot.

The section will outline the requirements, steps, and information necessary to connect the Aqua-Hot to the vehicle's 12V DC power system. Follow all guidelines and pay attention to all notes contained herein. Failure to adhere to these guidelines can inhibit unit performance, and may cause damage to the Aqua-Hot and/or the RV.

- Installation must be performed by a qualified, professional according to current national regulations. Reference A119.2/NFPA 501C Standard on Recreational Vehicles 1993 Edition for relevant national regulatory information.
- Select the correct wire gauge for installation referencing ANSI/RVIA-LV.
- Protect the Aqua-Hot from over-current and shorting by incorporating a 20A breaker (minimum) to the Aqua-Hot's RV-side power connection.
- The 12-volt supply to the heater must be routed directly from the battery.
- All power circuits must be protected with fuses or automatic circuit breakers.
- The 14AWG RV power and ground wires go directly into the butt splice shown below.
- Cover splice crimp with heat shrink once complete.

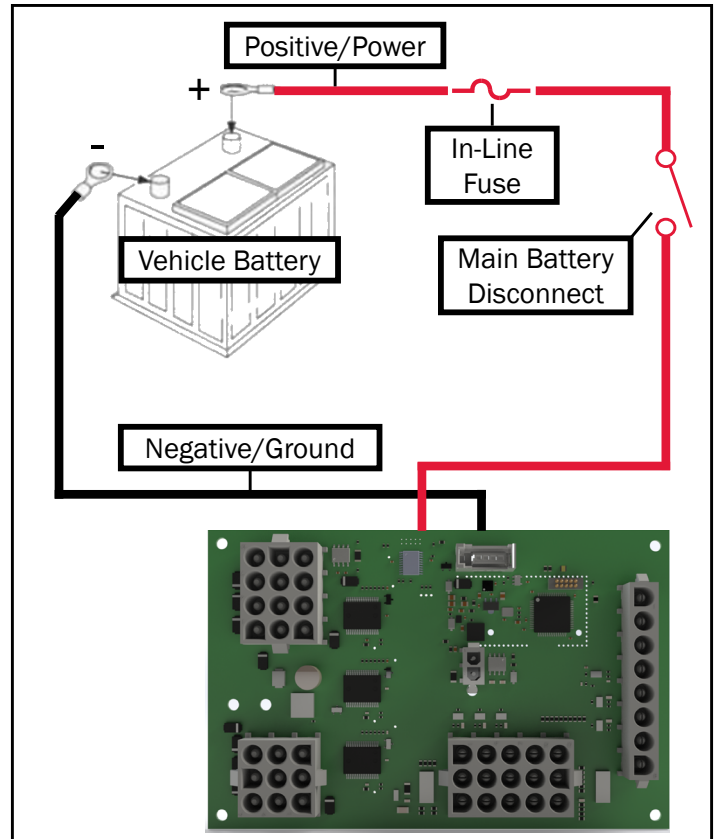

Figure 51

NOTE: The image above is simply a reference. A professional, licensed installer needs to determine the necessary components and configuration according to local codes and standards.

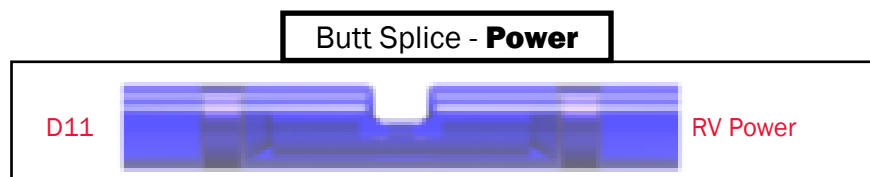

Figure 52

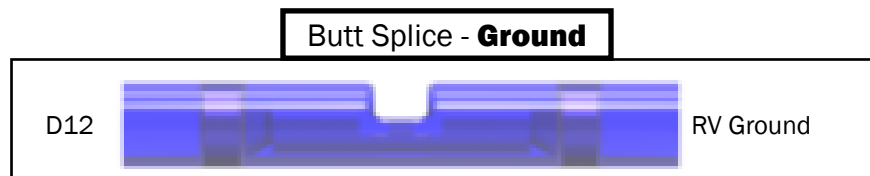

Figure 53

Connecting the Aqua-Hot to AC Power

The following section will detail how to connect the Aqua-Hot to the vehicle's AC electric system. Connect the 3-pin Molex connector to the coach-side AC electric system in order to utilize the Aqua-Hot's AC heating element.

The Aqua-Hot utilizes Molex 19403 and 19045 series connectors for the AC electrical circuit. These are self-contained connectors which can be readily purchased from your choice of electronics supplier. Listed below are three different mating connections.

Self-Contained Power Connector - 2 Circuit for Solid Wire		
Size	Part Number	Housing Color
12-14AWG (2.00mm ²)	19045-1000	White
Self-Contained Power Connector - 2 Circuit for Stranded Wire		
14-16AWG (2.00mm ²)	19403-1011	Blue
12AWG (2.00mm ²)	19403-1010	Yellow

- Installation must be performed by a qualified professional according to current national regulations. Reference A119.2/NFPA 501C Standard on Recreational Vehicles 1993 Edition.
- The boiler must be connected to a 120V AC supply permanently and be protected with a 20A breaker (minimum). The 120V AC must be separate from 12V DC.
- It must be possible to disconnect the power to the boiler, either an easily accessible plug or a circuit breaker.
- Please refer to the schematic on page 54.



Figure 54

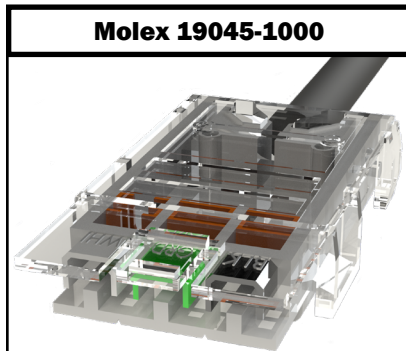

Figure 55

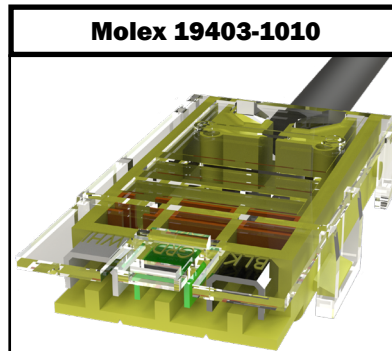

Figure 56

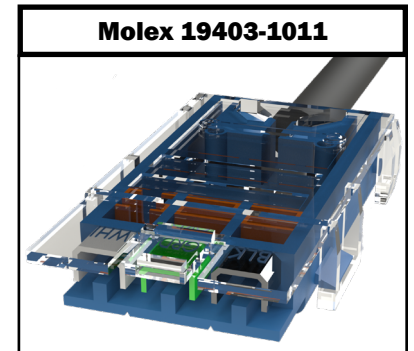

Figure 57

Heat Exchanger Installation Requirements

Cozy heat exchangers can be mounted in one of two configurations: either flat on the ground, or vertically. Reference Figure 58.

- Supply ventilation cross-sectional area of at least 29in² (74cm²) must be supplied to each heat exchanger.
- Do not supply heat exchangers air which is drawn from the bay areas.
- Return air should be drawn from the same room the heat exchanger is heating.
- The anti-freeze and water heating solution must flow in through the bottom of the heat exchanger, and out the top (reference Figure 69).
- The Aqua-Hot 125-DN2 is designed to work with up to 3 thermostatic heating zones.
- It is required to have a minimum of two (2) heat exchangers.

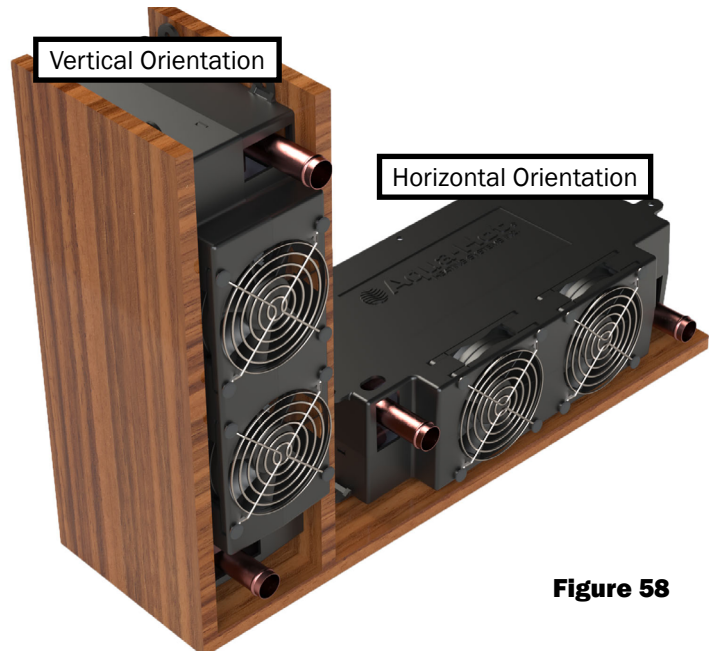

Figure 58

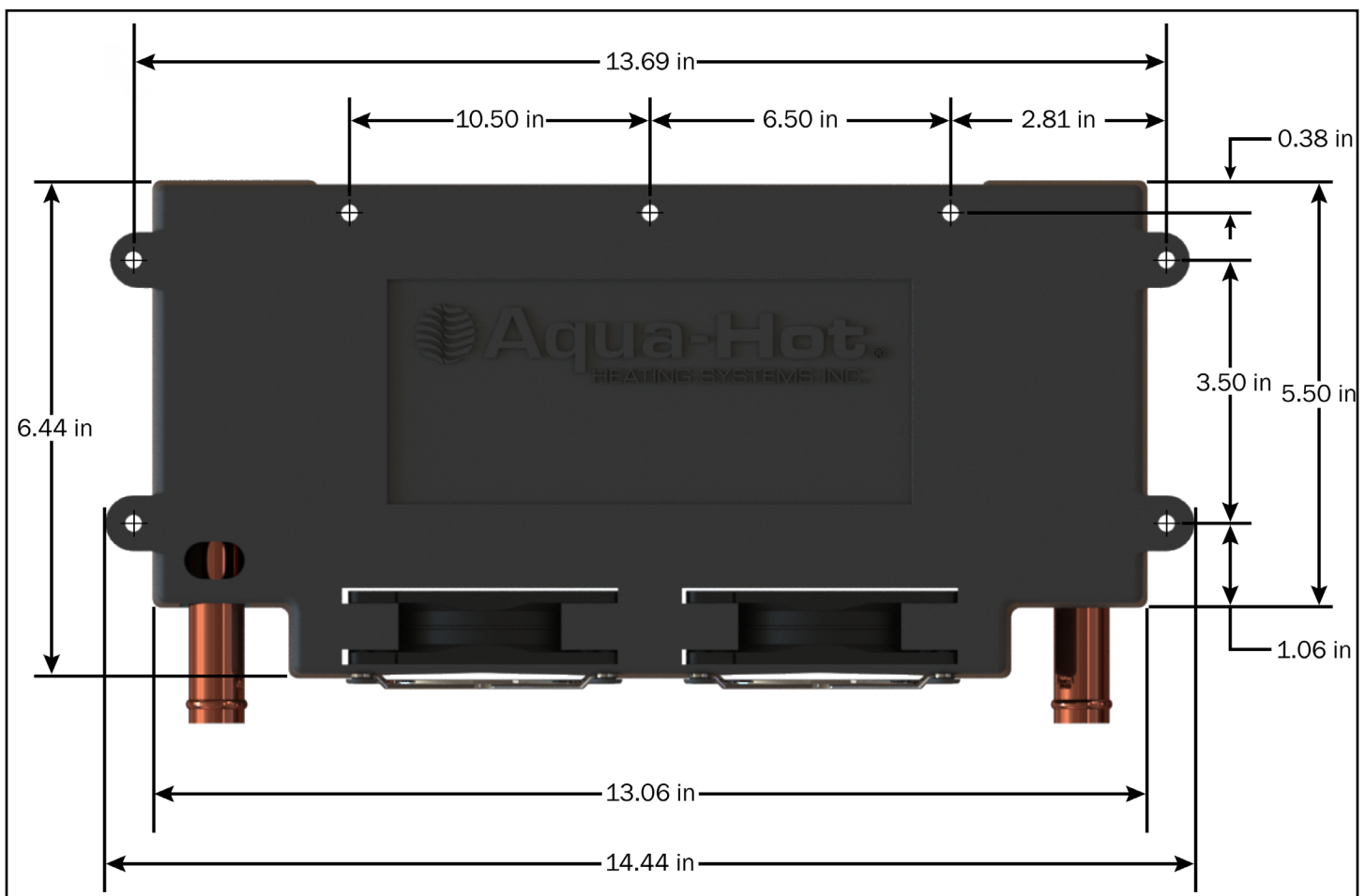

Figure 59

Heat Exchanger Locations and Clearances

- Position the heat exchangers so that even heat is distributed throughout the RV interior.
- The first heat exchanger on the loop will output the most interior heat.
- It is best practice to place the heat exchanger in an area where it can be easily accessed for maintenance.
- Place the heat exchangers as close to the floor as possible for best performance.
- If a heat exchanger is kept in the fresh water storage bay, then the last heat exchanger in the coolant loop should be used.
- The heating air supply may be fresh or recirculated air that is drawn from a clean area not likely to be contaminated.

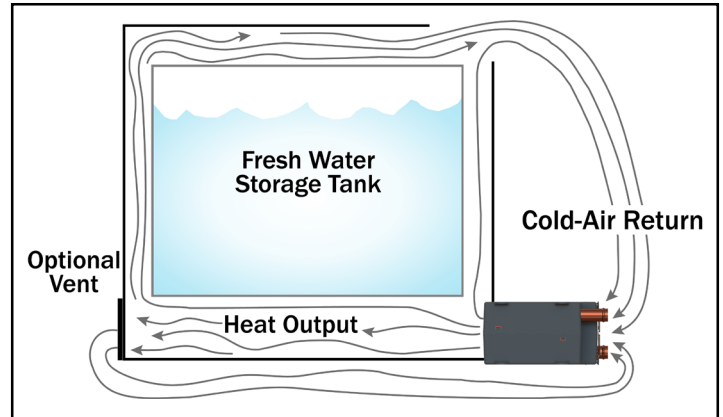

Figure 60

NOTICE

Aqua-Hot advises against placing a heat exchanger on the slide-out section of any vehicle due to the high probability of damage occurring to the heating loop from moving parts.

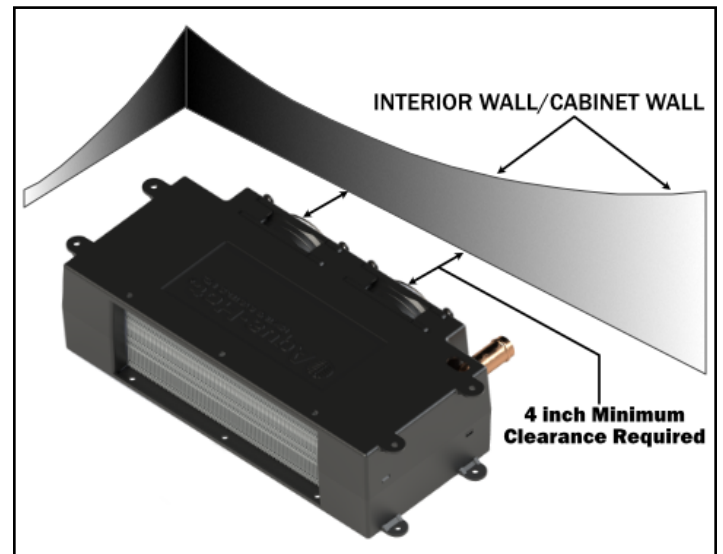

Figure 61

Mounting the Heat Exchangers

1. Cut out a 2.5" x 10" (7cm x 26cm) opening for each heat exchanger outlet and cold-air return grate as shown in Figure 63.
2. Mount each heat exchanger permanently into place. There are 4 tabs on both sides - see Figure 69.
3. Install the hot-air outlet and cold-air return grate.

A minimum of supply ventilation cross-sectional area of at least 29in² (74cm²) must be supplied to each heat exchanger.

If the toe-kick area is inadequate to house a heat exchanger for regular installation, a plenum assembly may be purchased to redirect air via ducting. Refer to Figure 62 & 64.

Plenum Assembly	
1. Hot Air Outlet Vent	4. Cozy Heat Exchanger
2. Air Ducting Hose	5. Toe Kick Board
3. Plenum	

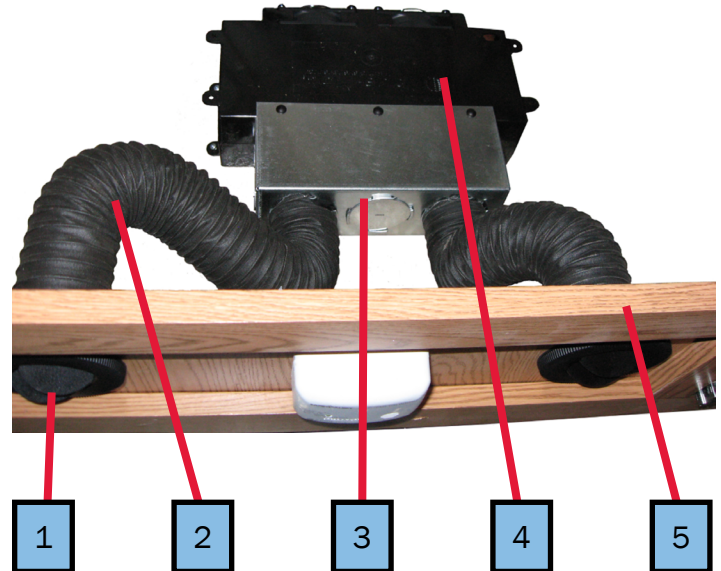

Figure 62

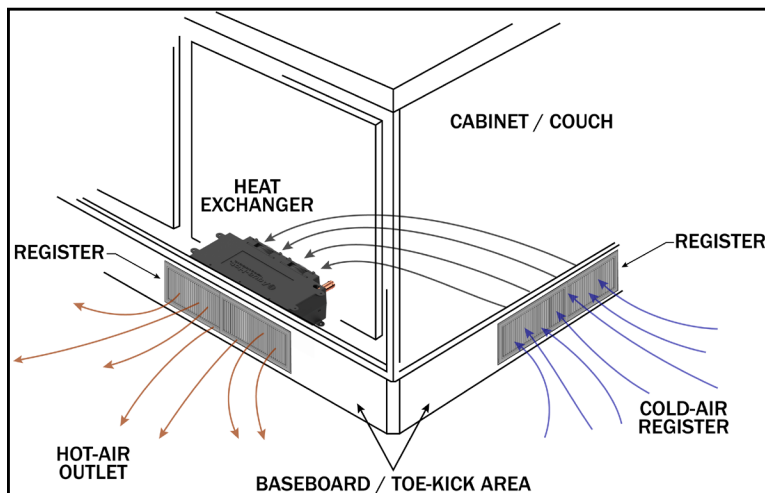

Figure 63

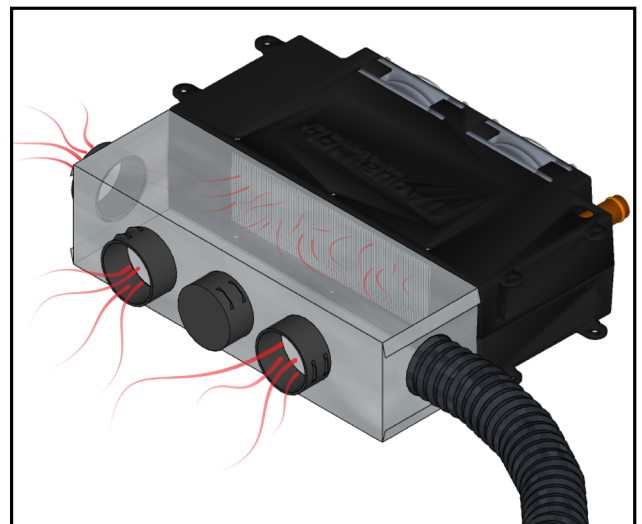

Figure 64

Wiring the Heat Exchangers

This section will explain in detail how to wire the heat exchangers for optimal functionality. Do not deviate from these guidelines. If a deviation is required, contact Aqua-Hot Heating Systems prior to installing these exchangers for express permission to proceed with modifications.

Instructions

1. Wire each heat exchanger (in a thermostatic zone) in parallel to one another as shown in Figure 67.
2. Wire each heat exchanger independently to the J7 plug of the unit controller.

NOTE: Quiet-mode functionality of the new controller requires that the heat exchangers be wired directly into the controller.

3. Pin-out information is shown below.

Thermostatic Zone Number	Supply (+) Pin Number	Ground (-) Pin Number
1	J7-1	J7-4
2	J7-2	J7-5
3	J7-3	J7-6

J7 Wire insertion view shown

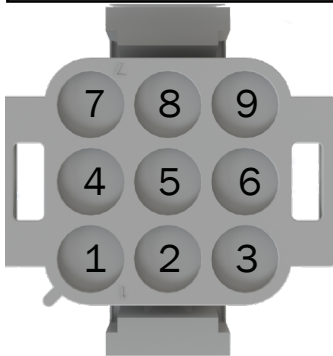

Figure 65

Connector Part Numbers		
Part Number	Manufacturer	Description
1-480706-0	TE Connectivity	J7 Plug Housing
350550-1	TE Connectivity	J7 Socket Terminal

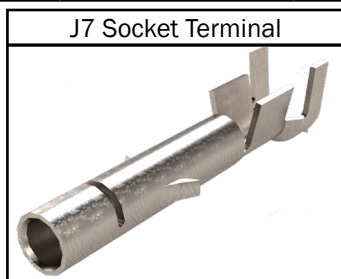

Figure 66

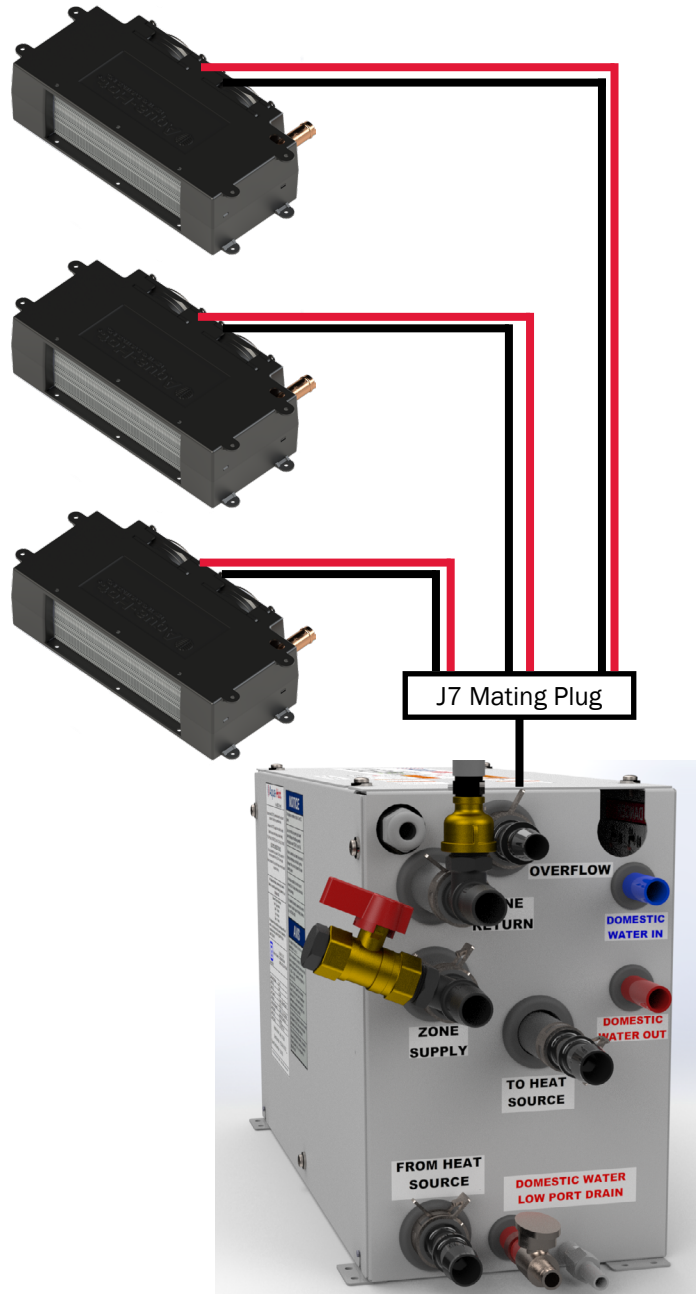

Figure 67

NOTE: The 125-DN2 can have up to 3 individual, thermostatic heating zones. The heat exchangers in different zones are wired to a different set of pins of the J7 plug.

Plumbing the Heating Zone

The following guidelines should be used when planning the coolant loop for the heating zone. The 125-DN2 requires a single fluid zone. The order of the heat exchangers should consider priority on the loop. Failure to adhere to these installation principles can hinder the operation of the heat exchangers.

- All plumbing should be installed as flatly as possible.
- Extreme rises in height should be avoided to avoid any potential air traps.
- Use 5/8" ID plumbing lines, 3/4" SAE J20 type coolant hose, heater hose, or PEX tubing for the single heating loop.
- Use wide-sweeping elbows or "bend supports" whenever the plumbing lines may be susceptible to kinking.
- Plumbing lines should be run in areas where there is no reasonable possibility that they can be pinched off or damaged under normal operating conditions.
- Secure all lines where necessary and apply protective shielding in areas where chafing may occur.
- Rubber coated/closed-type clamps are recommended when securing the plumbing lines.
- Inlet and outlet plumbing lines can be installed with a straight fitting or an elbow.

Instructions

1. Layout the plumbing lines for all heat exchangers (see the example in Figure 71).
2. Label each line and designate as an outlet or an inlet line.
3. Connect and clamp the outlet line from the heater to the lowest port (inlet port).
4. Connect and clamp a line from the first heat exchanger's highest port, and connect the other end to the next heat exchanger's lowest point.
5. Connect each additional heat exchanger in the same arrangement.
6. Connect and clamp the inlet line from the heater to the highest port on the last heat exchanger to complete the heating loop.

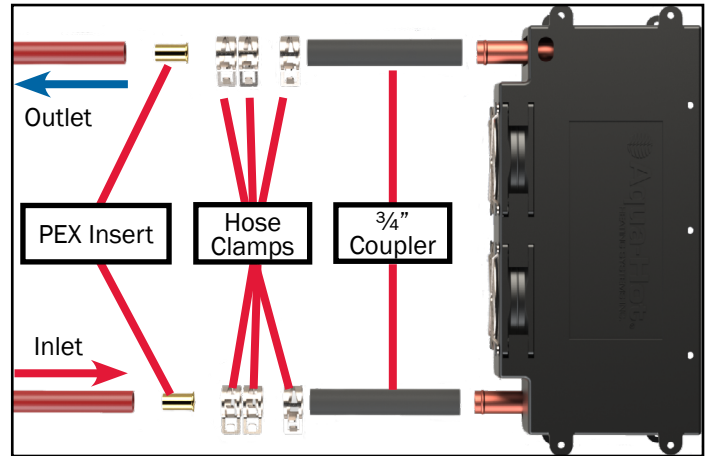

Figure 68

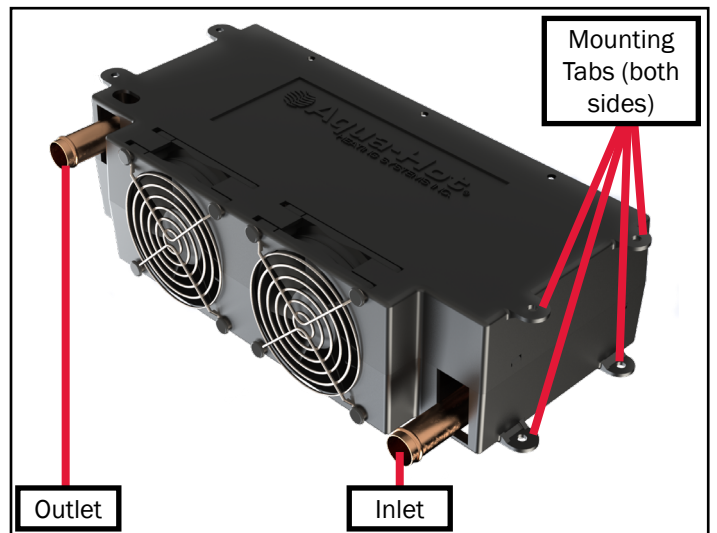

Figure 69

NOTE: This diagram below is simply a reference to show the layout and flow of the plumbing to and from heat exchangers. Placement and quantity may vary depending on the RV.

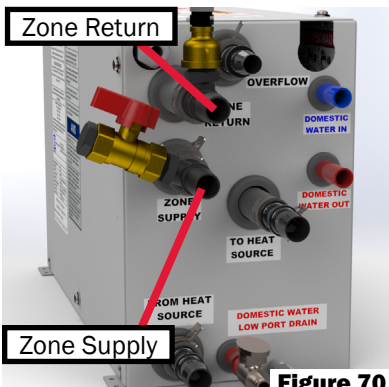

Figure 70

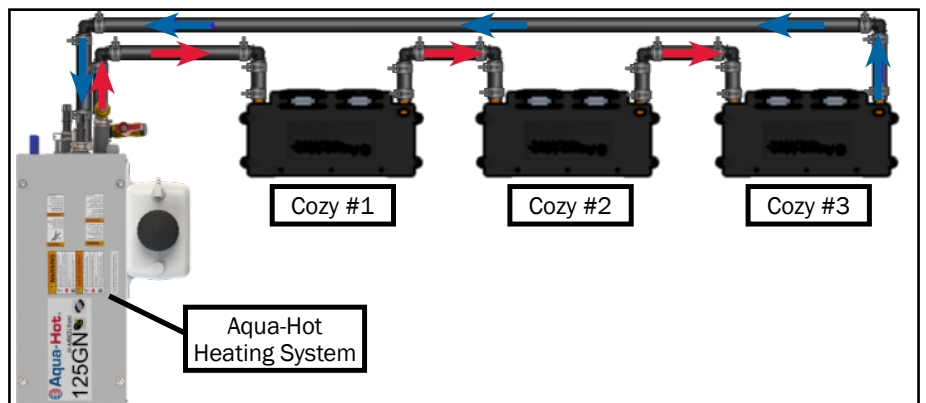

Figure 71

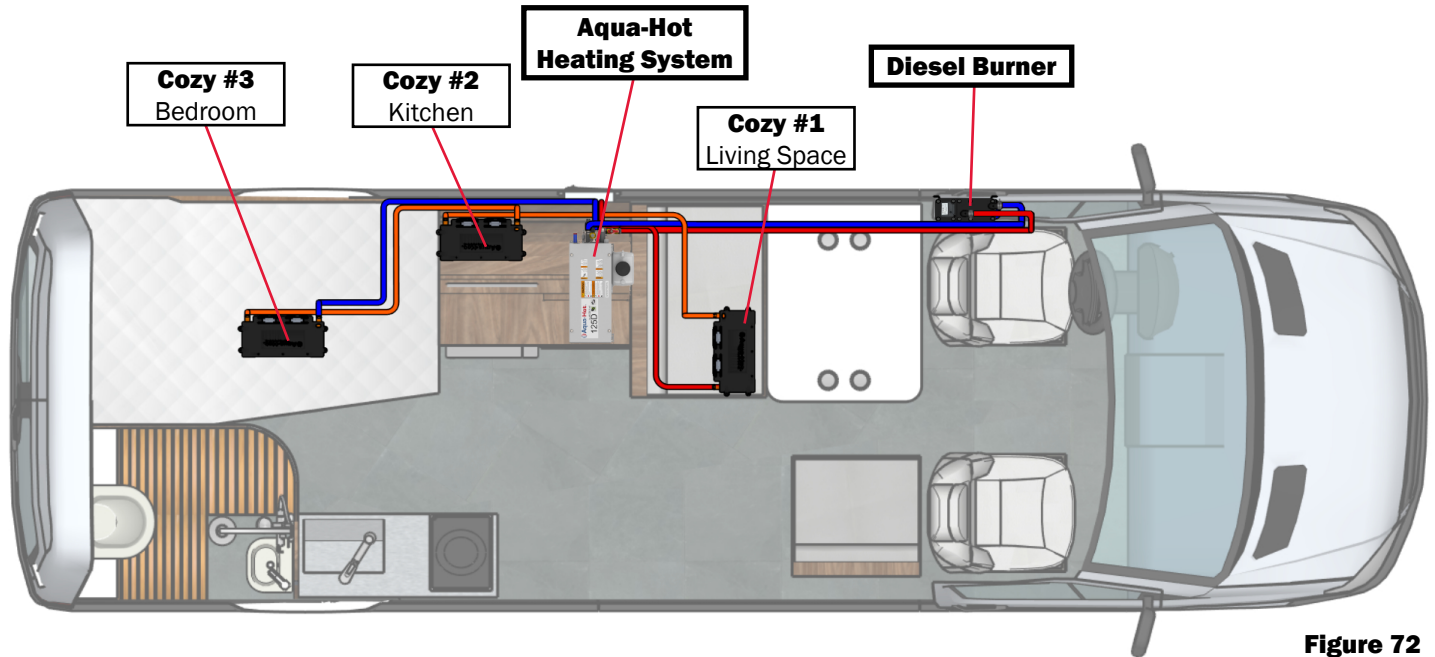

Figure 72

NOTE: This is just a sample for the layout of the diesel burner with the Aqua-Hot and heat exchangers. Actual placement may vary on the individual design of the RV. For questions or assistance, contact Aqua-Hot at 574-AIR-XCEL (574-247-9235).

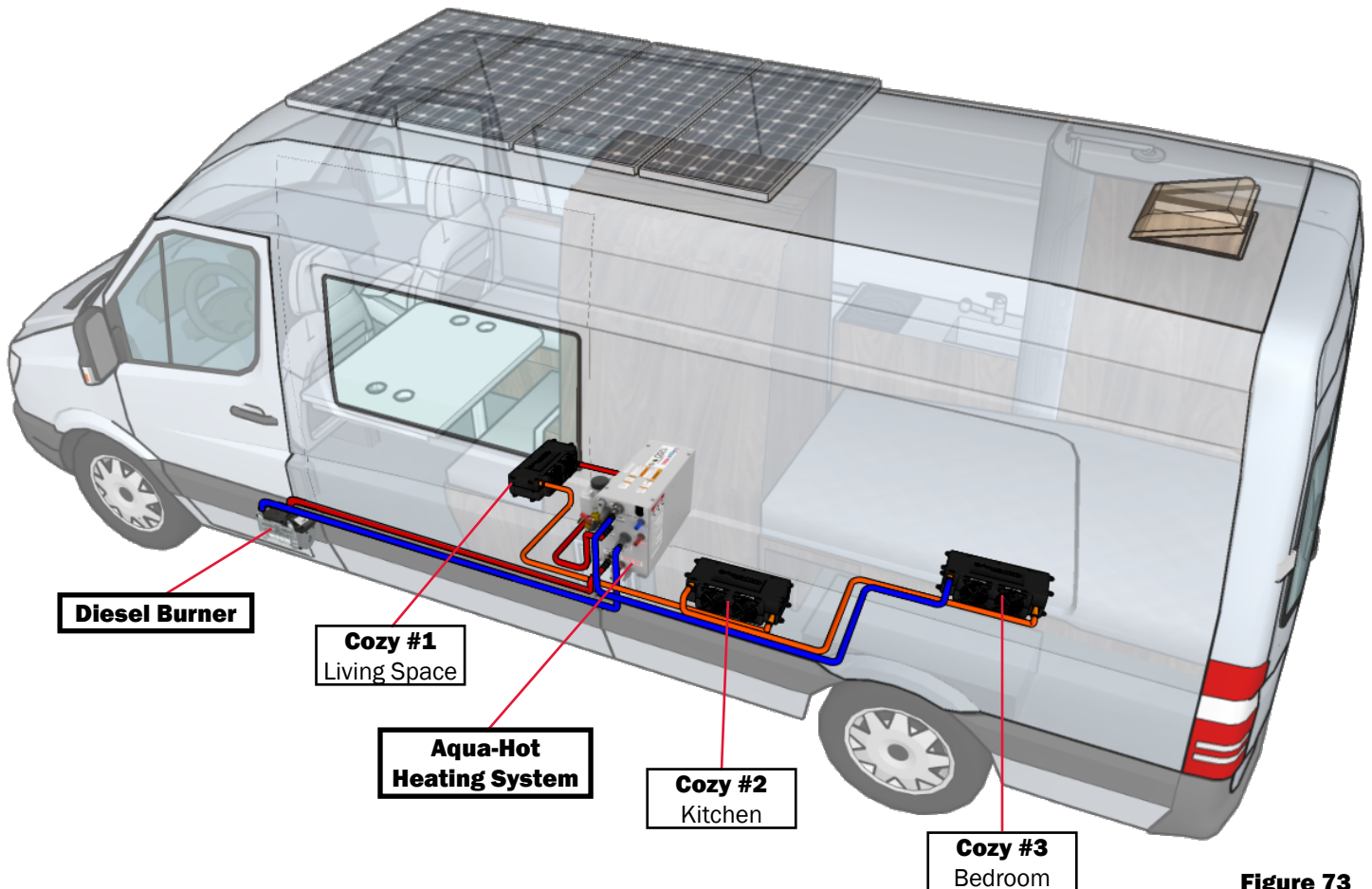

Figure 73

Domestic Water System Requirements

- Reference A119.2/NFPA 501C Standard on Recreational Vehicles 1993 Edition for relevant regulatory information regarding the design of Domestic Water Systems.
- The Aqua-Hot is equipped with a pressure relief valve and a tempering valve in order to provide safe hot water without chance of scalding or an over-pressurized system.
- Plumb the domestic water system according to Figure 75.

Plumbing the Domestic Water System

The Aqua-Hot is also able to provide domestic hot water while the boiler tank is up at operating temperature. Activate the external diesel burner to provide adequate heat for hot water needs. The electric element will only provide light duty hot water.

The tempering valve is integrated into the cabinet of the Aqua-Hot, and is set upon departure from the Aqua-Hot factory. So long as the tempering valve is not modified, it will provide hot, non-scalding water.

Instructions

1. Locate the domestic cold water inlet (blue PEX tube) and connect it to the vehicle's domestic cold water system.
2. Locate the domestic hot water outlet (red PEX tube) and connect it to the vehicle's domestic hot water system.

⚠ DANGER

Risk of Severe Burn or Death from Scalds. Water temperature over 51°C (123.8°F) can cause severe burns instantly or death from scalds. See instruction manual before setting temperature at water heater. Feel water before bathing or showering. Temperature limiting valves are available, see manual.

WARNING:
HOT WATER CAN PRODUCE 3RD DEGREE BURNS
- IN 6s at 60°C (140°F)
- IN 30s at 54°C (129.2°F)
WATER DELIVERY TEMPERATURE MIXING VALVE WAS FACTORY SET AT 49°C (120.2°F).
CONTACT QUALIFIED SERVICE PERSONNEL FOR ADJUSTMENTS.

Risque de brûlures graves ou la mort de brûlures. De l'eau à une température au-dessus de 51 °C (123,8 °F) peut ébouillanter et causer instantanément des brûlures graves allant jusqu'à la mort. Consultez le manuel d'instructions avant de régler la température du chauffe-eau. Vérifiez la température de l'eau avant de prendre un bain ou une douche. Des soupapes de limite de température sont disponibles, voir le manuel.

AVERTISSEMENT:
L'EAU CHAUDE PEUT PRODUIRE DES BRÛLURES DE TROISIÈME DEGRÉ
- EN 6s à 60°C (140°F)
- EN 30s à 54°C (129.2°F)
LA VANNE DE MÉLANGE DE TEMPÉRATURE D'ALIMENTATION EN EAU A ÉTÉ RÉGLÉE EN USINE À 49 °C (120,2 °F).
CONTACTER DU PERSONNEL DE SERVICE QUALIFIÉ POUR LES ADJUSTEMENTS.

LDE-003-260



Figure 74

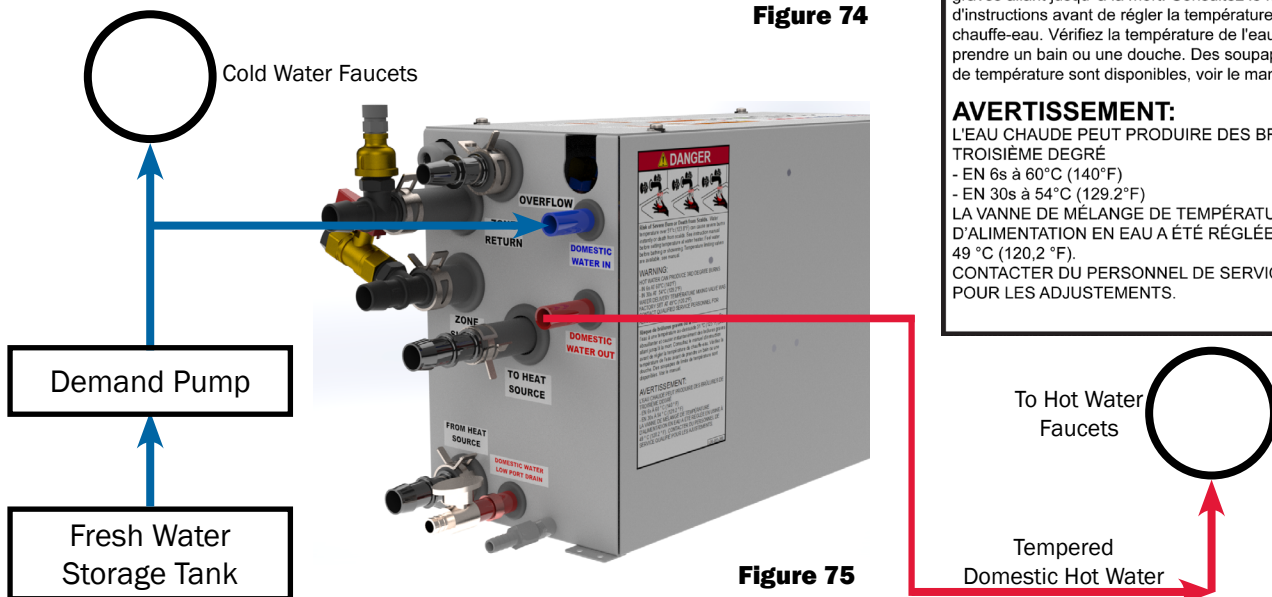

Figure 75

Mounting the Aqua-Hot LCD

This following section will explain in detail how to mount the Aqua-Hot LCD on the interior of the RV.

Mounting Considerations:

- Purchase the necessary RV-C connection parts according to the table below.

Manufacturer	Part Number	Common Name
3M	37104-A165-00E-MB	Network Port
General Cable	E2104S.41.02	RV-C Communication Cable

- Route the 15' RV-C cable from the intended mounting position of the LCD to the Aqua-Hot Controller.
- The LCD screen is powered via the RV-C cable which connects directly to the Aqua-Hot Controller, or via an on-board RV-C network.
- "DATA ONLY" RV-C cable configurations are not compatible with the LCD screen.
- The screen requires at least 3/4" (1.9cm) of backside clearance to allow room for cables and connections.
- Reference Page 36 for more information on the RV-C Network Connectivity.

Mounting Procedure

1. Select a location within the RV.
2. Cut a 2.50" x 3.64" hole in the RV wall.
3. Route the corners of this cutout with a .35" diameter bit.
4. Using four countersunk #6 screws, secure the LCD bracket into place over the cutout just made.
5. Connect the RV-C cable to the back of the LCD screen. Reference Figure 76.
6. Snap the LCD screen into the mounting bracket.

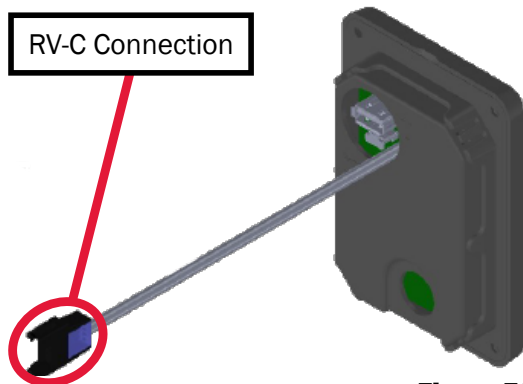

Figure 76

3.5" LCD Diagnostic Screen



Figure 77

NOTE: Please note that the LCD Screen mounting bracket may only be mounted in this configuration as shown below. The screen will not fit in properly any other way.

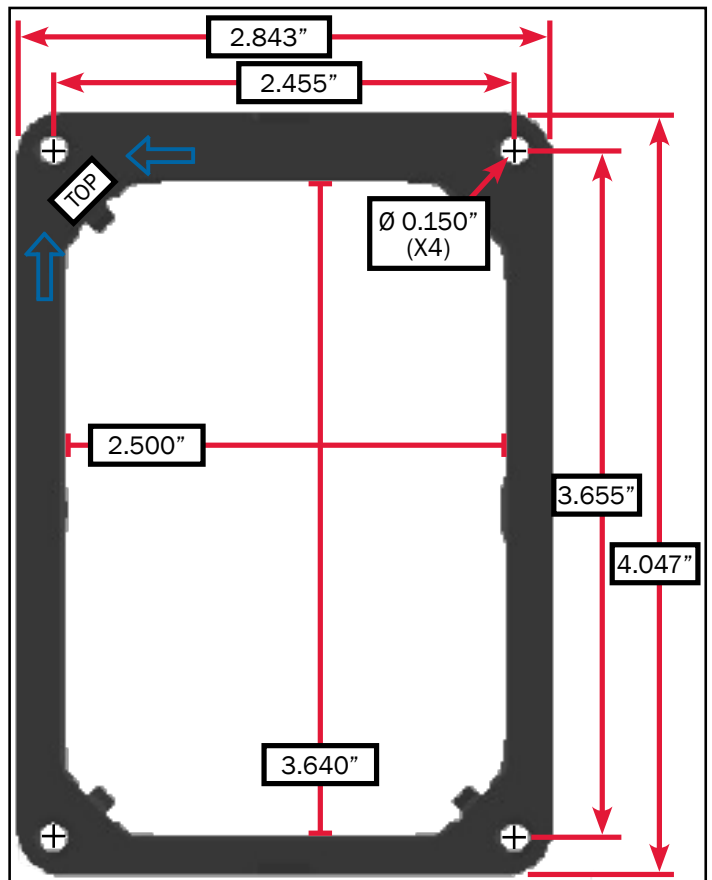

Figure 78

Operating the LCD & Aqua-Hot

This section will outline the basic operating instructions for the Aqua-Hot LCD Screen.

Climate Pages:

The climate pages are for all intents and purposes the “Home” of the LCD screen. From here, the end-user will select their interior temperature set-points, activate or deactivate the diesel burner and/or the electric element.

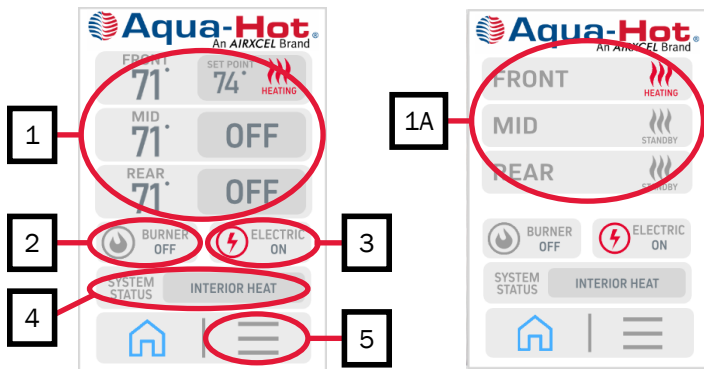

Zone Control (1):

Precise zone control display will differ depending on the type of zone thermostats/thermistors used within the RV.

Section 1A demonstrates the appearance of the zone control section when ON/OFF thermostats are used within the RV. In this use-case, these buttons serve only as ON/OFF toggle switches.

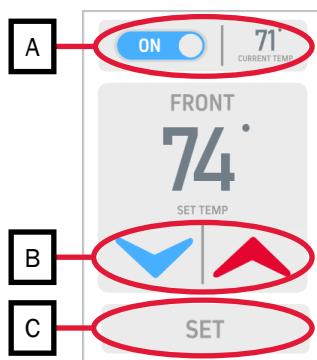

Tapping on one of the zones shown above will display a new screen where the interior temperature can be set.

Section A:

This section shows the current zone temperature (shown as 71°F in the example above) as well as a button to turn the zone on or off. (Setting specific temperatures can only be done *if* thermistors are installed. Thermostats would only show ON/OFF.)

If the zone temperature is set, but this item is not set to ON, the zone heat exchanger will not activate.

Section B:

These arrows are used to increase or decrease the desired set-point temperature of the zone thermistor.

Section C:

After the desired temperature set-point has been selected tap “SET” on the LCD to set that temperature. The Aqua-Hot will now work to maintain this interior temperature, and the screen will return home.

External Diesel Burner Activation (2):

The external diesel burner of the Aqua-Hot can be activated by tapping on the “burner” item on-screen. The diesel burner has two modes: ON and OFF.

ON:

While set to ON, the Aqua-Hot diesel burner will work to maintain a tank temperature of 180° F, with a minimum tank temperature of 160° F.

OFF:

While off, the diesel burner will not serve to provide any heat to the boiler of the Aqua-Hot whatsoever.

Electrical Element Activation (3):

Similar to the external diesel burner, tapping this button will signal to the controller to activate the AC electric relay, energizing the 1500W electric element within the Aqua-Hot. The electric heating element has two modes: ON and OFF.

ON:

While set to ON, the electric element will work to maintain a tank temperature of 180° F, with a minimum tank temperature of 160° F.

OFF:

While off, the element will not serve to provide any heat to the boiler of the Aqua-Hot whatsoever.

System Status (4):

This item will indicate the current operational status of the Aqua-Hot. If any faults have triggered, those will be displayed here.

During normal operation, this should display either INTERIOR HEAT or HOT WATER relating to the priority and position of the 3-way valve.

While in INTERIOR HEAT mode, the 3-way valve is oriented so as to circulate heated antifreeze and water solution through the heating zones of the RV.

While in HOT WATER mode, the 3-way valve is oriented so that the heated antifreeze and water solution is circulated immediately back into the boiler tank. This is known as “stirring” the tank, and it is done to provide as much heat as possible to the domestic water line while water is flowing.

Module Options (5):

Tapping on the module options screen (the 3 lines on the bottom right of the home screen) will display the screen shown above. This is known as the Module Options screen. From here, it is possible to access unit diagnostics, activate Quiet Mode, change the temperature units, adjust screen brightness, and unit timeout.

Screen Timeout (A):

The screen timeout item sets the amount of time required to allow the screen to shut-off when idle.

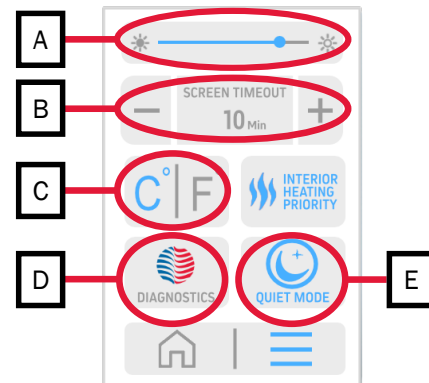

Screen Brightness (B):

This setting changes the screen brightness.

Unit of Measurement (C):

This setting will change the display units of the Aqua-Hot. Either Fahrenheit or Celsius can be selected.

Diagnostics (D):

Tapping on this element will direct you to the Aqua-Hot’s built-in diagnostic, testing, and troubleshooting tools.

Quiet Mode (E):

This option toggles the Aqua-Hot’s quiet mode. Quiet mode is a setting where the speed and output of the heat exchanger fans is reduced to 80%. This is done to reduce noise of the heat exchangers.

Please note that this feature must be activated and deactivated as needed.

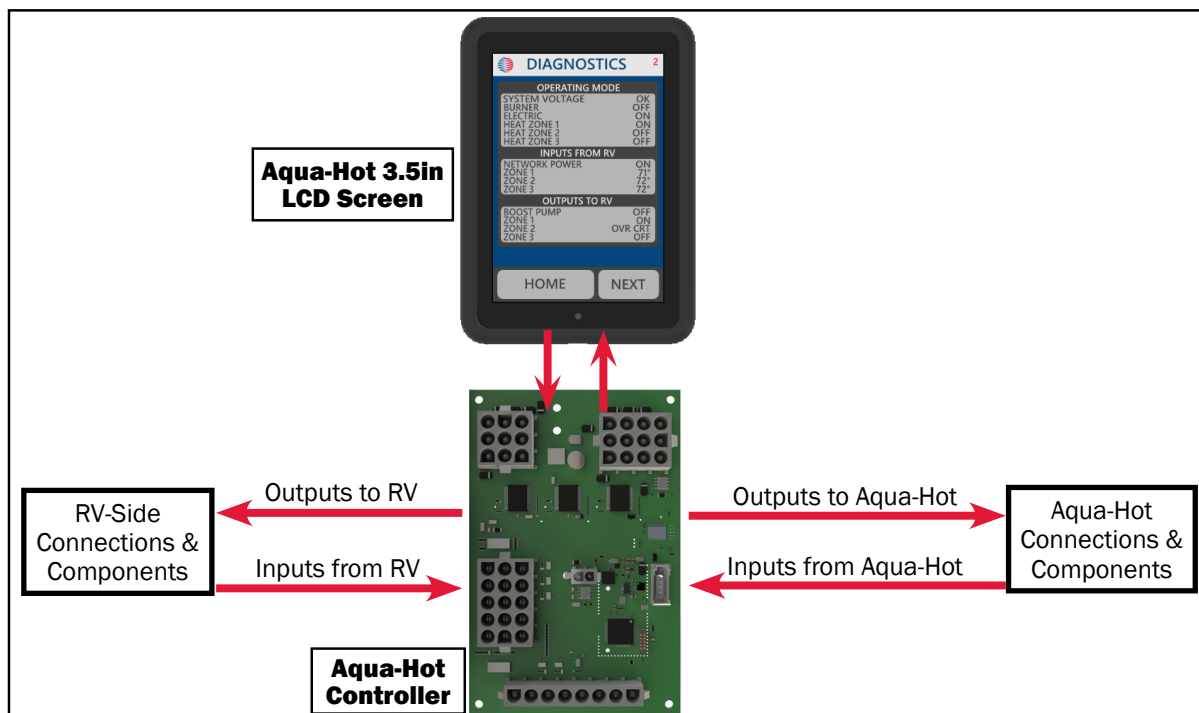

Figure 79

Configuring the Zones

Once the heat exchangers and thermostats have been wired to the Aqua-Hot, the Controller must be configured in order to correctly manage these zones.

Configuration:

In order to configure these zones for first use, locate the Aqua-Hot LCD screen and navigate to the Aqua-Hot Diagnostics section.

After holding the serial number section above, you will be presented with an options panel like the one shown below.

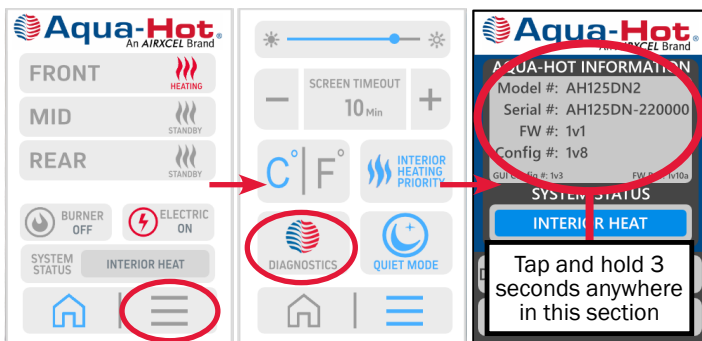

Tap OPTIONS, and then CLIMATE ZONES to access the climate zone configuration sub-menu.

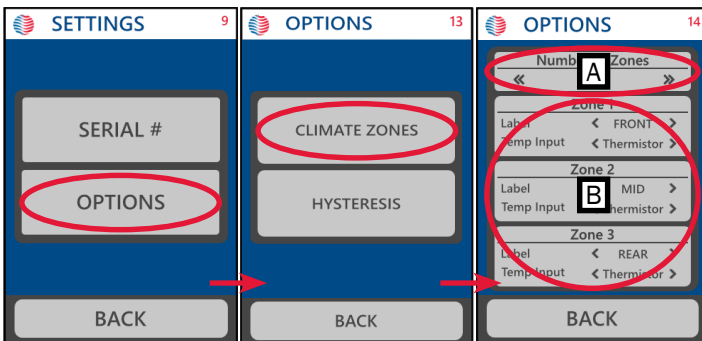

Changing Zone Settings:

Once the Climate Zone section has been accessed, the information below will explain how to correctly configure the zones.

Number of Zones (A):

The Aqua-Hot can control between 1 and 3 heating zones within the RV. Modifying this will set the Controller to manage 1, 2, or 3 heating zones.

Zone Settings (B):

Zone settings will change the way each zone is labeled on the home screen of the LCD, as well as the type of thermostat used in the RV interior.

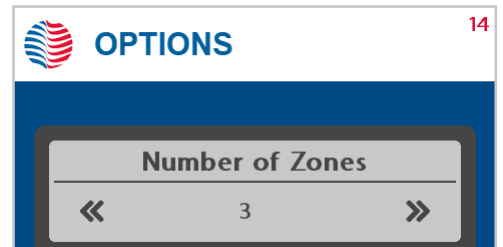

Modifying “Temp Input” will change the type of signal that is expected by the Controller.

- Set to “Thermistor” if an interior thermistor is to be used.
- Set to “Thermostat” if a traditional ON/OFF thermostat is to be used.

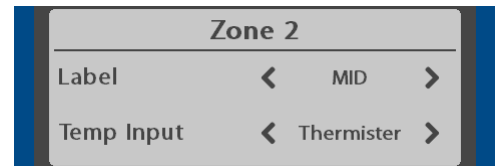

Modifying “Label” will change how the zone is displayed. There are three choices; Front, Mid, and Rear which correspond to the zones within the RV. See example below.

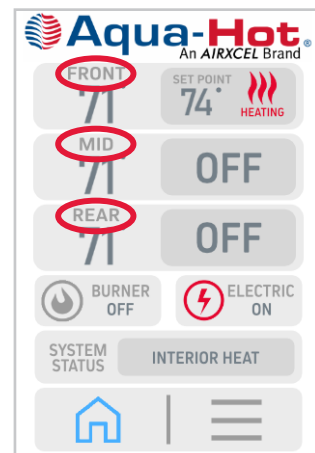

RV-C Network Connectivity

The Aqua-Hot LCD is designed to interface with the RV-side RV-C network to aid in the Aqua-Hot's integration into the on-board RV-C network.

There is an indicator light on the back of the LCD which shows the current status of the LCD's connection to the RV-C network. This will be useful when diagnosing potential problems with the RV-side RV-C network.

LED Activity		Status
		Solid Green Device is connected to network and communicating properly
		OFF Device has no power, or has failed completely
		Solid Red Device has gone offline and is not connected to network
		Fast Flashing Green (4x/second) Device is attempting to make an initial connection to the network
		Slow Flashing Green (1x/second) The Device is online, but it has not received a valid network message for at least 5 seconds
		Alternating Red and Orange Device has gone offline and is attempting to re-connect (within 30 seconds)
		Alternating Green and Orange Device is currently online but has gone offline 2 or more times

NOTE: For networked control of the LCD, Aqua-Hot requires system integrators ensure that individual commands are received and processed. Aqua-Hot requires that commands be repeated or confirmed so that if a single message were dropped, or if there is a brief network disturbance, the LCD would get into the correct state as soon as the disruption was removed.

The Aqua-Hot LCD monitors the heating system and handles all logic relating to safeties and heating control. As such, the system integrator is required to display all pertinent status information but not use that information to lock out operation or add additional safety layers that could impact the end of operation if a message from the LCD was missed.

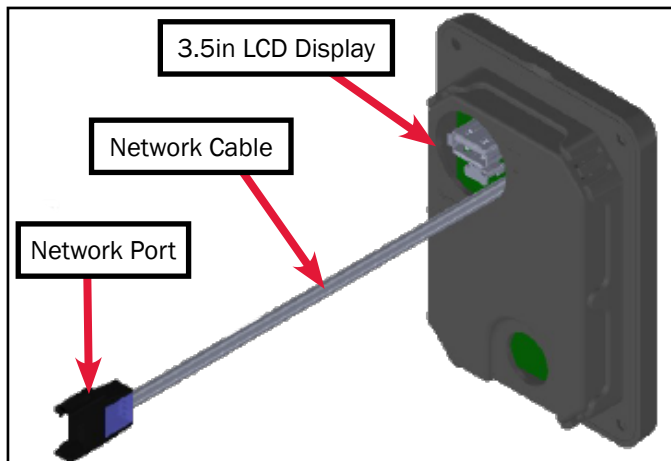

Figure 80

Network Port		
Pin Number	Description	Color
1	12V DC Power	Red
2	CAN H	White
3	CAN L	Green
4	Ground	Black

Figure 81

Operational Specs	
Operational Voltage Range	9 to 14.5V
Source Voltage Must Not Exceed	± 18 VDC
Operational Current Draw	0.1A
Storage Ambient Temperature Range	-40 to +176 °F
Operational Ambient Temperature Range	-13 to +122 °F

RV-C Terminating Resistor

NOTE: A terminating resistor (supplied with every 125-DN2) is provided in-line with the RV-C cable for any standalone system used in the RV-C network.

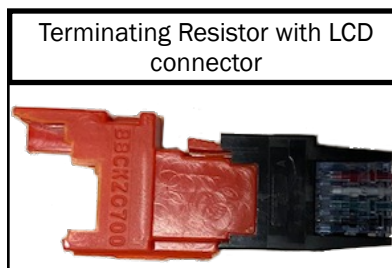

Figure 82

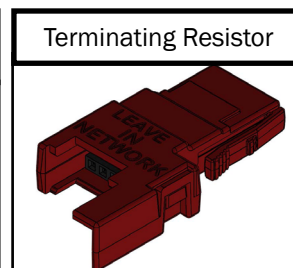

Figure 83

Filling the Aqua-Hot

Before the first activation of the Aqua-Hot, fill the unit with antifreeze and water heating solution. Without the solution present, the Aqua-Hot will not operate. Follow the directions below to fill the Aqua-Hot with antifreeze and water heating solution.

A mixture of 50/50 **Ethylene Glycol** antifreeze and distilled water is recommended. The mixture may be modified to provide the most adequate freezing, boiling, and rust/anti-corrosive protection. Reference page 55 for measuring the antifreeze mixture with a refractometer The Aqua-Hot 125-DN2 boiler tank holds approximately 1.8 gallons.

Ethylene Glycol												
Freeze Point (°F)	32	25	20	15	10	5	0	-10	-20	-30	-40	-50
Concentration (%)	0	10	16	21	25	29	33	39	44	48	52	56

Fill Instructions

1. Locate the following items:
 - Exterior fluid pump (a diaphragm pump if possible)
 - The Aqua-Hot fluid expansion bottle
 - A bucket or pale
2. Locate the glycol product which is to be used in this heater.
3. Fill the bucket with the antifreeze and distilled water solution.
4. Locate the fluid fill port (shown in Figure 85).
5. Ensure that the fluid expansion bottle is connected to its port on the Aqua-Hot, but must be elevated higher than the Aqua-Hot unit.
6. Connect the external fluid pump to the fluid fill port.
7. Place the intake hose of the external pump in the receptacle which contains the heating solution.
8. On the LCD screen, navigate to the TESTING page, turn on the pump, and set the 3-way valve to "HOT WATER".

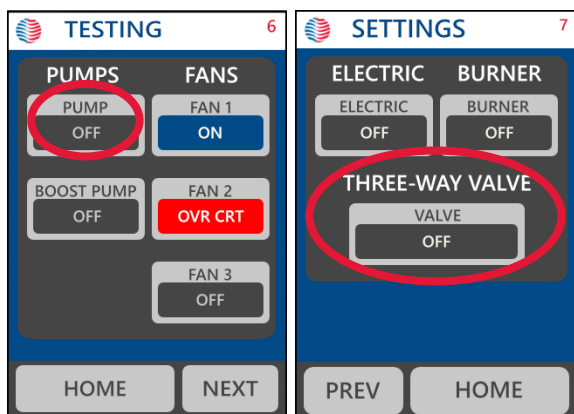

Figure 84

WARNING

Make sure to select the correct glycol antifreeze product for the external diesel burner. Failure to select the correct product could seriously damage the diesel burner.

9. Activate the supply pump, open the fluid fill valve, and fill the unit while paying attention to the fluid expansion bottle. Allow this pump to run until the fluid level in the expansion bottle reaches the "COLD" mark.
10. Once the "COLD" mark has been reached, close the fluid fill valve and deactivate the external fill pump.
11. Remove the external fluid fill pump.
12. Proceed to the next page to purge the zone before attempting to start the unit.

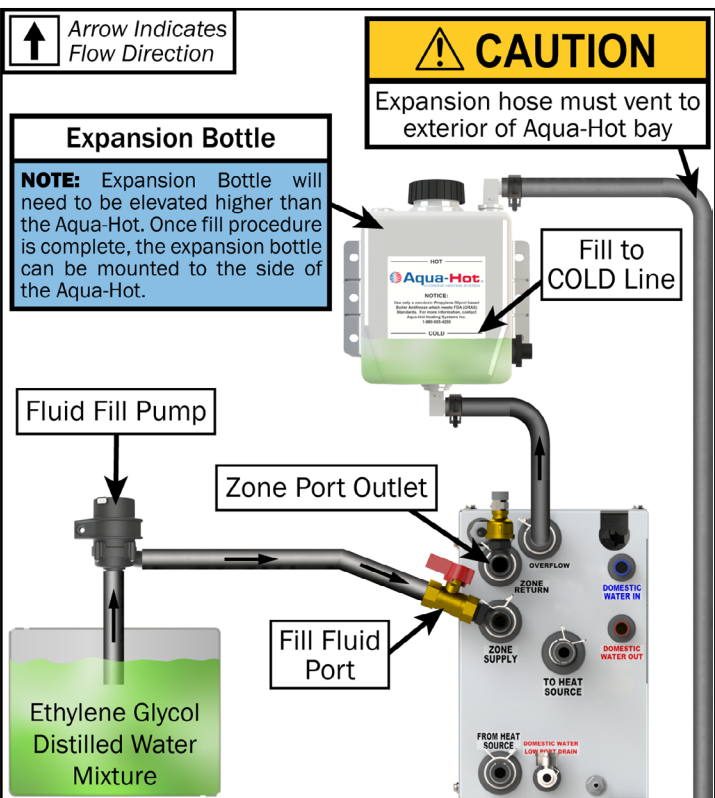

Figure 85

Purging the Interior Heating Zone Loop

During installation, it is possible that air may become trapped within the heating loop and hamper unit performance.

Follow this procedure to purge any air from the interior heating loop.

Purge Procedure

1. Locate the fluid expansion tank of the Aqua-Hot. As any air is purged, it will exit through to this expansion bottle.
2. Locate a gallon of the antifreeze and water heating solution. This will be used to top-off the fluid expansion bottle as air is purged from the system.
3. Locate the Aqua-Hot LCD screen. This display may be mounted in a location away from the Aqua-Hot. Contact the vehicle manufacturer for assistance in locating this display.
4. Tap the screen to wake the display.
5. First tap the three lines at the bottom right of the screen, then tap "AQUA-HOT DIAGNOSTICS".
7. Tap "PUMP" to activate the fluid circulation pump, and if applicable, "BOOST PUMP" to activate the zone boost pump.

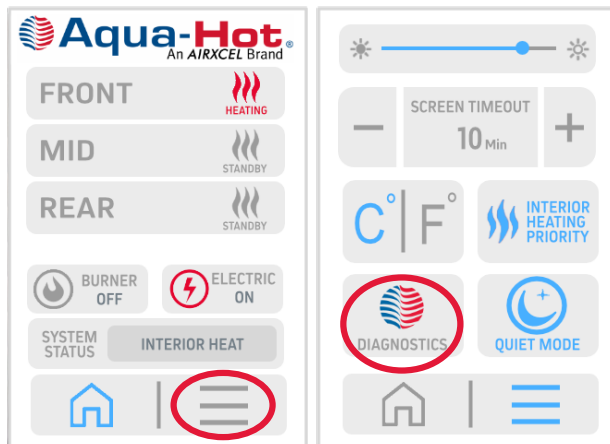

Figure 86

6. Tap "TEST" on the display to access the testing functionality.

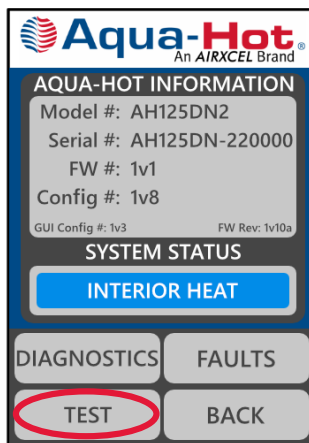

Figure 87

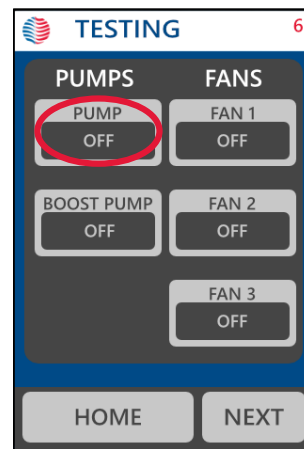

Figure 88

8. These pumps will run for a maximum of five minutes. Re-activate as necessary until they are run for at least twenty minutes.
9. Refill the fluid expansion bottle as necessary to keep it at the "COLD" line.
10. Once this process is complete, mount the fluid expansion bottle in its permanent location.

Fuel System



WARNING

Failure to follow instructions on the fuel delivery system can cause damage to the Aqua-Hot 125-DN2, the diesel burner, or the RV. It may cause serious personal injury. Please follow instructions carefully.

NOTE: The First Install Kit includes all the couplers, clamps, and fuel lines needed for a proper install of the fuel system.

Fuel System Requirements

- The diesel fuel supply should be drawn directly from the vehicle's main fuel tank if applicable. A separate 1.3g fuel tank may be installed if necessary.
- The fuel tank should be equipped with a dedicated fuel pick-up pipe. Make sure the fuel standpipe does not impair the operation of the vehicle's fuel delivery or fuel gauge in any operating mode.
- The fuel pump should be fixed in the vehicle with a fuel pump clamp with a protective rubber cover. The fuel outlet should tilt upwards, with an angle between 15°-35°.
- Use the provided Ø4mm x 1mm (to heater - transparent) fuel line and Ø2mm x 5mm (to fuel tank - blue) fuel line with the included couplers and clamps.

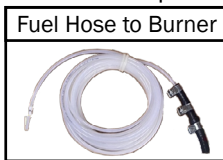

- The fuel line must be kept as short as possible. The total length of the fuel line should not exceed 29 feet.
- The fuel line should be laid out as flatly as possible, avoiding extreme rises in height to eliminate any air traps.
- The fuel standpipe must be positioned vertically and the end should sit at least 30-40mm above the tank bottom.

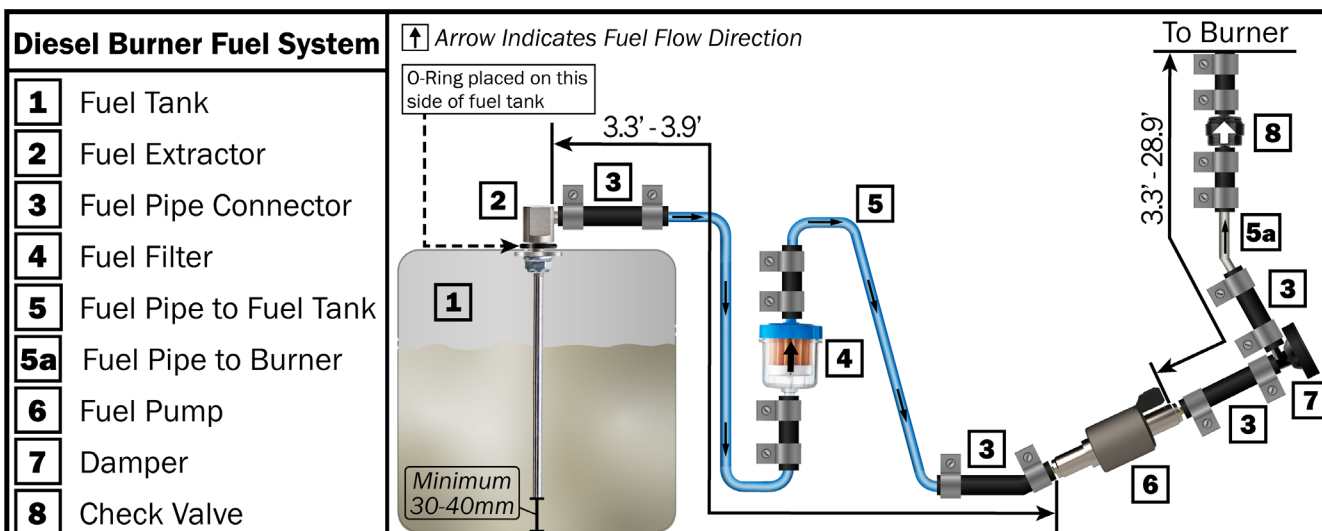

Figure 89

DANGER

Fuel can cause fire or explosion that can create severe personal injury or death. Do not store/transport a remote fuel tank *inside* the RV. Notice all applicable codes and regulations for storage, transporting, and handling of remote fuel tanks. Follow instructions to ensure safe operation and check for fuel leaks before operating the burner.

- The fuel filter should be installed before the fuel inlet of the fuel pump. Make sure orientation and position of the filter is accurate with the flow of fuel.

Fuel Standpipe Installation

- Drill a 6mm hole through the top of the fuel tank using the 6mm drill bit provided in the First Install Kit.
- Remove sharp pieces, and smooth edges with sandpaper or an emery cloth. Place an O-ring beneath the fuel pipe seat.
- Determine the length of the standpipe so the end is at least 30-40mm above the bottom of the fuel tank.
- Cut off excess standpipe at a 45° angle, remove any sharp edges.
- Place sealing compound on the threads of the compression fittings and thread onto the tank boss. Tighten the compression fitting completely.
- Place the standpipe into the tank hole at an angle. Slip one side of the tank boss inside the hole.
- Bring the standpipe up vertically and insert the other side of the tank boss through the tank hole.
- Center the standpipe in the fuel tank hole.
- Pull up on the standpipe and tighten in place with the clamping nut. Do NOT over-tighten the nut to prevent the rubber washing becoming distorted.

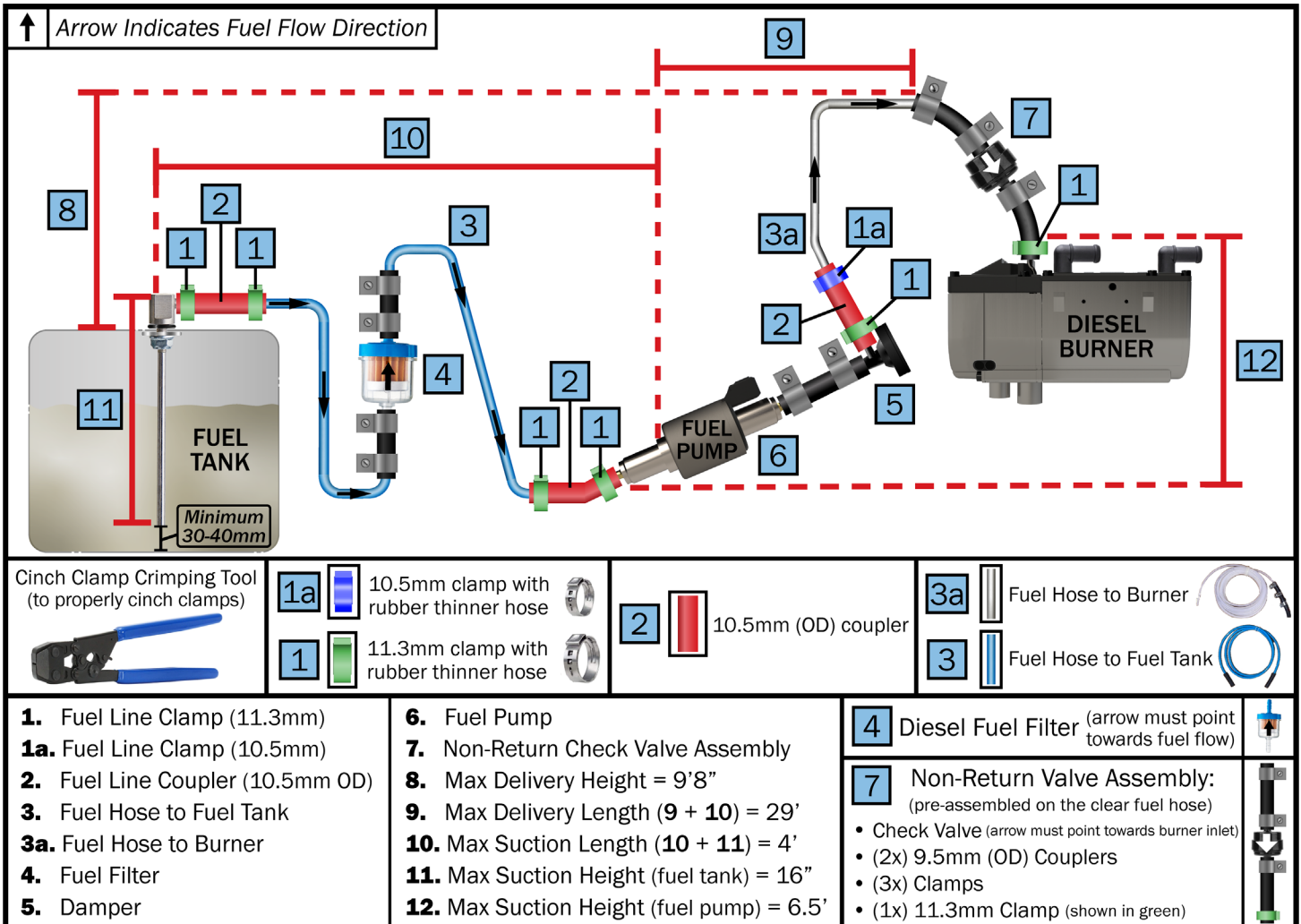

Figure 90

NOTE: The diagram above is not drawn to scale. It is simply a reference for proper installation of the fuel system for the Diesel Burner.

Fuel Lines Requirements

- Reference the diagram above for the fuel line installation.
- Use the provided Ø4mm x 1mm (to heater - transparent) fuel hose and Ø2mm x 5mm (to fuel tank - blue) fuel line with the included couplers and clamps. See Figures 90 & 96



- The fuel hose should not be descending from the fuel pump to the burner - see Figure 90.
- The fuel line should be properly secured to avoid sagging.
- The fuel line must be installed in a manner that won't cause damage to the fuel line (i.e. close to exhaust).
- The fuel line must be secured to the connections and couplers by hose clamps. See Figures 90 & 96.

Fuel Filter

- The fuel filter should be installed before the fuel inlet of the fuel pump. Make sure orientation and position of the filter is accurate with the flow of fuel. Reference Figure 90 & 94.
- It is recommended to replace the filter once a year or after extended period of non-use.

Fuel Pump

- The fuel pump is a combined pumping, metering, and shut-off system. It pumps fuel from the vehicle supply to the burner via the fuel lines.
- The fuel pump should be mounted to the vehicle with a fuel pump clamp with protective rubber cover (included in First Install Kit).
- The outlet of the fuel pump is required to be installed upwards. The angle should be between 15°-35°. See Figure 92 for fuel pump orientation.

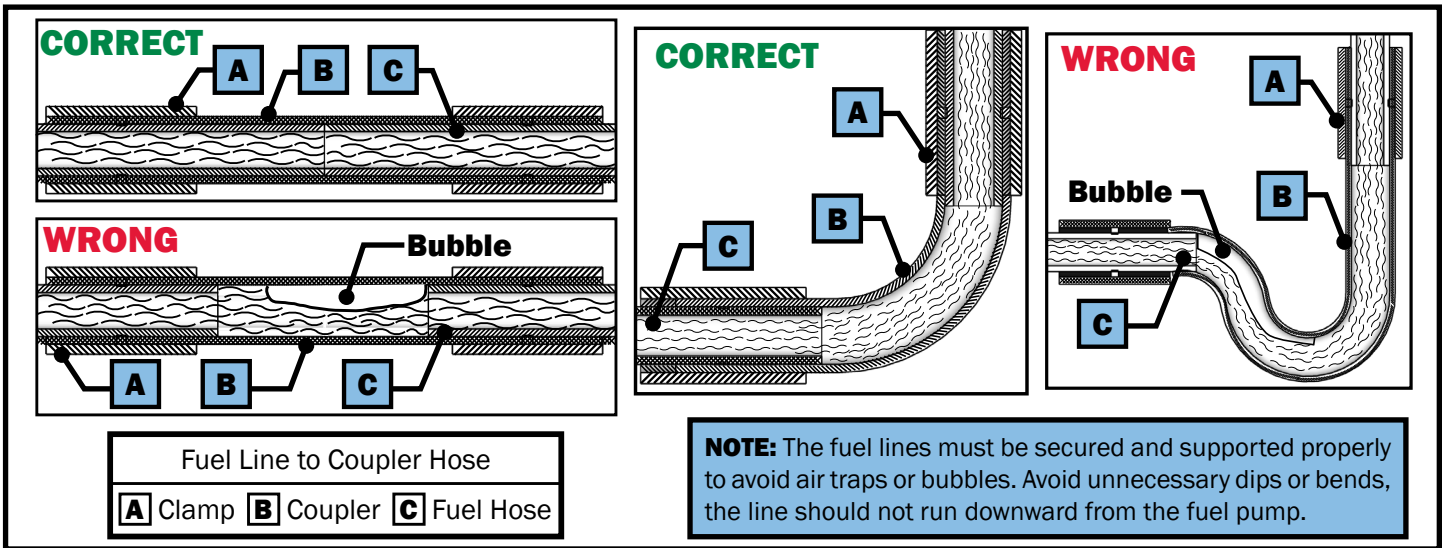

Figure 91

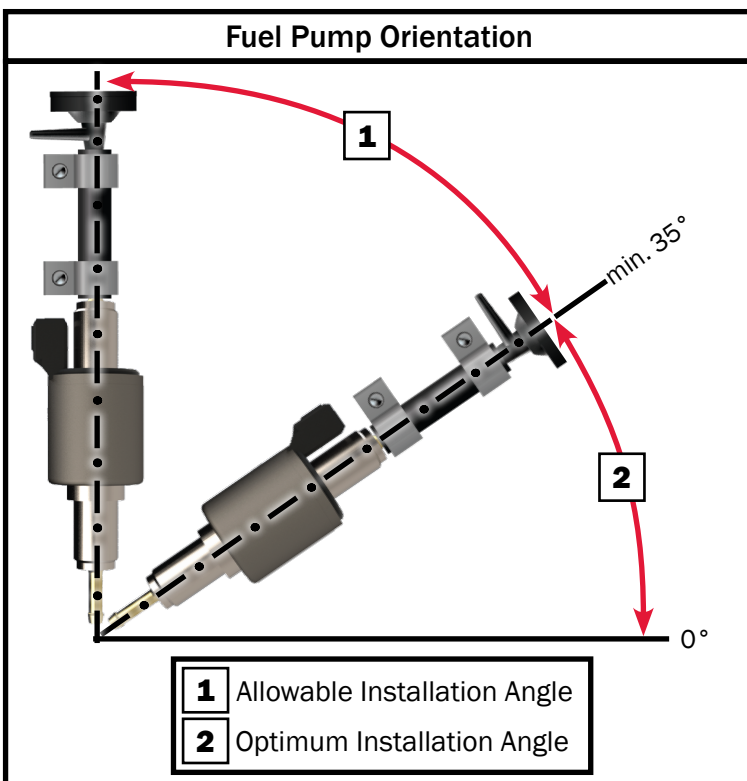

Figure 92

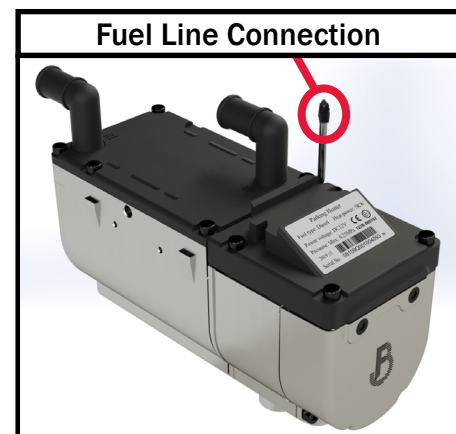

Figure 93

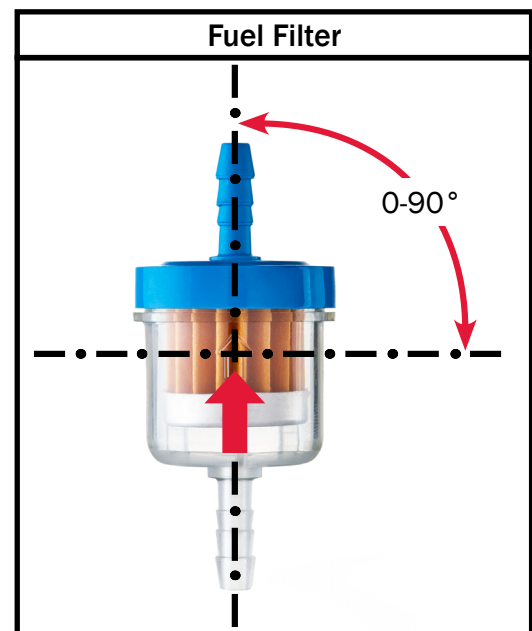

Figure 94

DANGER

Fuel can cause fire or explosion that can create severe personal injury or death. Do not store/transport a remote fuel tank *inside* the RV. Notice all applicable codes and regulations for storage, transporting, and handling of remote fuel tanks. Follow instructions to ensure safe operation and check for fuel leaks before operating the burner.

Fuel Clamps

The fuel lines and couplers must be properly crimped to avoid leaks or air in the fuel system. Below are images of what properly crimped cinch-clamps should look like.

The two types of clamps used are shown below in the install bags. The clamps are color-coordinated on the bags and also the diagram in Figure 90 to avoid any confusion.

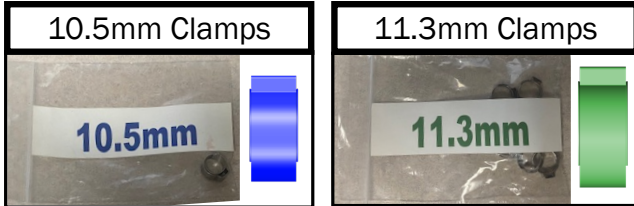

Figure 95

Fuel Couplers

Make sure to confirm the correct couplers and clamps are placed properly according to the diagram in Figure 90. The clamps must be crimped properly using the cinch clamp crimping tool as shown above in Figure 95. Using soapy water or PAM on the fuel lines can assist in sliding the couplers on.

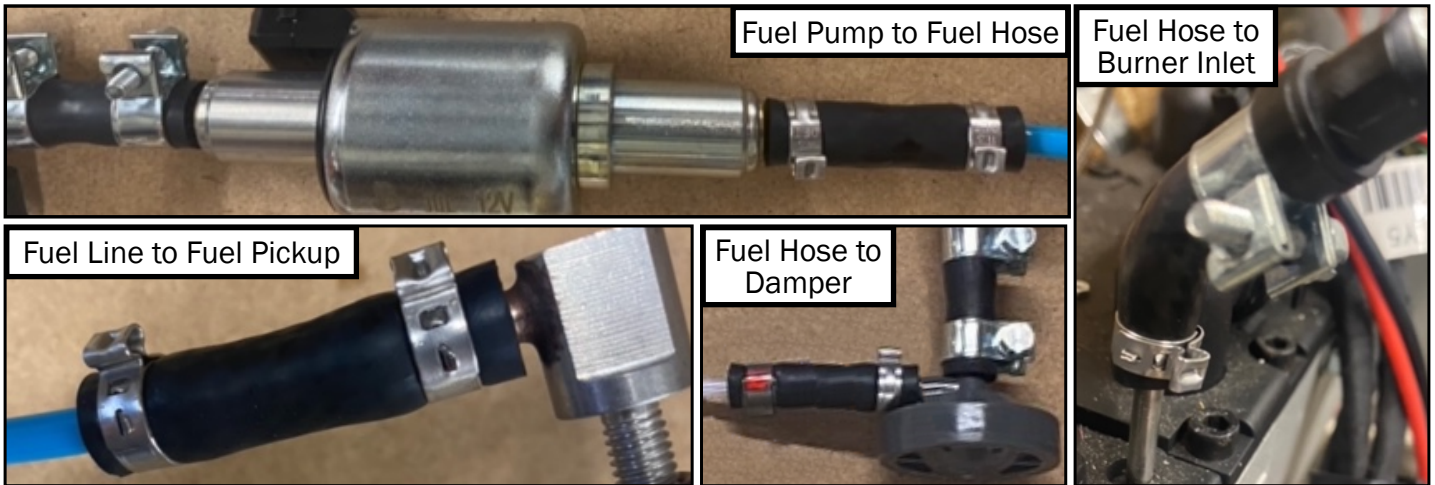

Figure 96

Fuel System Purge Procedure

Perform this procedure once the burner and Aqua-Hot are completely installed and the Aqua-Hot is adequately filled and purged.

The fuel lines should be automatically primed with the first operation of the burner. It may take 5-6 starts for the burner to ignite for the first start-up after installation, because the fuel pump needs to fill the fuel lines leading to the burner for ignition. An ignition failure may occur within the first 5-6 starts.

Perform this procedure once the burner and Aqua-Hot are completely installed and the Aqua-Hot is adequately filled and purged.

NOTE: DO NOT run the diesel burner without the coolant filled and purged as it will cause serious damage to the burner.

NOTE: The fuel lines can be fully primed by turning the burner ON/OFF via the LCD screen (Figure 99) without having to direct power and pulse the fuel pump. Once the burner starts and cycles, and any Ignition Failures/Faults are clear, the burner is ready for operation.

1. Connect a 12V power source to the fuel pump to pulse the pump. The power source must be able to be pulsed (turned on and off) rapidly for this process.



WARNING

Do NOT exceed 12V when powering the fuel pump. This can cause irreparable damage to the fuel pump.

- The pump can be powered with wire and gator clips. The Pin numbers are labeled below:



Figure 97

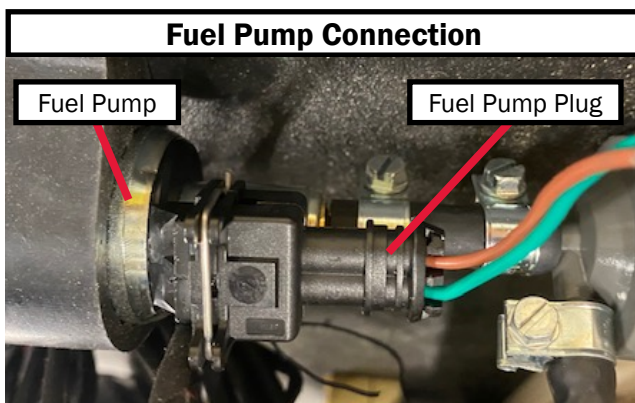

Figure 98

- Ground goes to Pin #1
- Power goes to Pin #2
- If you would rather use a plug instead of the wire and gator clips, the mating part numbers needed for the connector are:
 - Housing: 1-967644-1
 - Terminal; 0965906-1
 - Seal: 0-967067-1

2. Pulse the fuel pump at a steady 1-2 pulses per second until fuel begins to come out of the fuel line where it will connect to the burner.
3. Connect the fuel line to the burner.
4. Ensure all hose clamps and fuel fittings are tight and properly secured, and the exhaust is well ventilated.
5. Turn the burner on at the screen (see Figure 99). The burner should cycle on because of the primed fuel lines.
 - There may be smoke from the exhaust on initial start-up, this is normal.
6. If the burner does not cycle on with the first start up, it will try a second time.
 - If the second start-up fails, there will be a fault message on the LCD screen (Figures 100-101). Tap the burner OFF at the screen.
 - Repeat Step 6.
 - If fault occurs again, repeat Steps 4-6.
7. After a successful start up, run the burner for 5 minutes.

After a complete, successful first operation, the fuel lines should be purged of any air and ready for normal operation and use.

NOTE: Once the fuel lines are primed, the fault should clear, but the fault may need to be reset in the process. Just press the RESET button (Figure 101) to clear all the faults.

LCD Screen Burner Status on Fault Codes

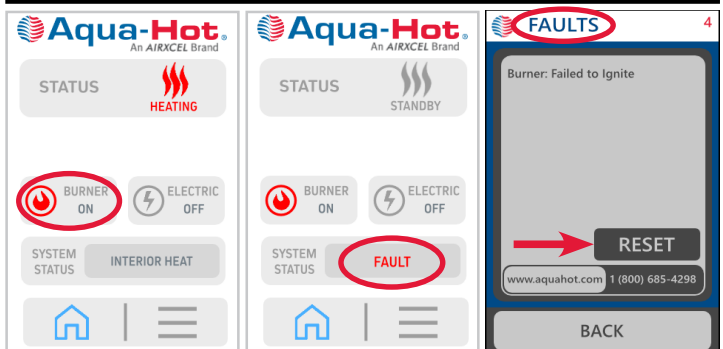

Figure 99

Figure 100

Figure 101

External Diesel Burner Troubleshooting

The troubleshooting procedures listed below are arranged in order of repair complexity. Do not replace parts without correctly determining the failure. Follow the directions below in order to troubleshoot the diesel burner. Do not skip through the troubleshooting steps, as this may needlessly complicate unit diagnosis and repair.

Troubleshooting Procedure:

- Ensure that the system is supplied with electrical power and there are no blown fuses.
- Ensure that there is at least ¼ tank of fuel in the vehicle fuel supply and the fuel filter is not clogged.
- Make sure all the electrical and plumbing connections are connected and secure.
- Ensure there are no faults for the burner. If there are, determine the fault and remedy.

The fault is indicated on the diagnostic screen by the Burner Status ON/OFF indicator as shown below. When the burner is turned ON, the LCD screen will show STATUS as “FAULT”. Tapping on FAULT will take you to the FAULTS screen which will display “Burner: Failed to Ignite”. After about a minute, the fault screen will show the specific fault code. Refer to the table on the next page for the fault codes and their remedies.

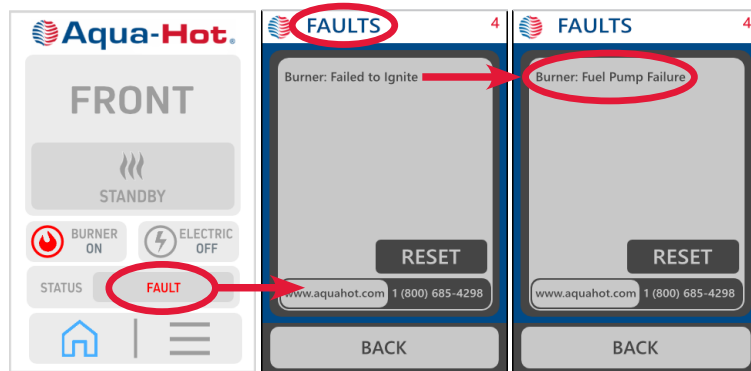

Figure 102

Triggering Overheating Fault:

If there is an overheat fault, the overheat failure is generally caused by the temperature in the Aqua-Hot.

A lack of antifreeze/distilled water solution may cause overheating failures, because the Aqua-Hot temperature cannot be carried away by the antifreeze/distilled water solution.

If the antifreeze/distilled water solution is sufficient and well-circulated, there will be no overheating failure as long as the antifreeze/distilled water solution does not exceed 203 °F.

NOTE: After the fault cause has been eliminated, the burner must be switched on again.

Heater Lock-out Reset Procedure

The control unit continuously monitors the heater operation. The control unit identifies errors on individual burner components and faults during operation. Should the control unit experience component errors and operational faults, the burner may be shut down and not restart.

The burner lockout reset must be done manually as shown below.

Troubleshooting Procedure:

- Turn on the burner, on the interior control panel.
- Remove the main power connection to the burner or pull the fuse for a minimum of 20 seconds.
- Turn the burner off on the interior control panel.
- Reconnect the main power connection that was previously disconnected.

External Diesel Burner Faults & Remedies

Fault Code	Fault Cause	Remedy	Fault Code	Fault Cause	Remedy
10	Burner: Voltage too high (exceeds 16V)	• Check power supply	51	Burner: Failed to Ignite Combustion chamber temperature is too high prior to ignition	• Wait for flame sensor cooling
11	Burner: Voltage too low (lower than 10.5V)	• Check power supply / battery voltage			• Replace flame sensor (normal resistance about 10K Ω)
12	Burner : Overheat (>228.2°F)	• Check coolant level, refill coolant if low after the heater cools down, restart • Check the circulation pump to see if working properly			52
13	Burner: Failed to Ignite		• Check whether air inlet pipe or exhaust pipe is blocked		
14	Burner: Over-Temp Coolant Overheat		• Check temperature sensor (normal temperature resistance about 10 Ω) • Replace temperature sensor		
17	Burner: Over-Temp - Hardware (>233.6°F)				
13	Burner: Failed to Ignite Second failure (burner failed to ignite 2 times)	• Check whether fuel pipe is blocked or fuel tank is low • Check whether air inlet pipe or exhaust pipe is blocked	60	Burner: Temperature sensor absent/broken circuit	• Check flame sensor (normal temperature resistance about 0.8 Ω) • Replace flame sensor
			61	Burner: Temperature sensor short-circuit	
20	Burner: Heat Plug Failure Absent/broken circuit	• Clean up carbon deposits • Replace glow plug • Replace controller	62	Burner: Coolant temperature is too high prior to ignition	
21	Burner: Heat Plug Failure Short Circuit		64	Burner: Flame sensor absent/ broken circuit	
22	Burner: Heat Plug Failure Poor/Reduced Performance		65	Burner: Flame sensor short-circuit	
23	Burner: Heat Plug Failure Heat Plug Voltage not detected		71	Burner: Overheat sensor absent/ broken circuit	• Check overheat sensor and wiring
30	Burner: Fan Speed too high	• Replace burner controller	72	Burner: Overheat sensor short-circuit	• Replace overheat sensor
31	Burner: Fan absent/broken circuit	• Check if fan wheel is binding • Replace fan motor assembly • Replace Controller			• Replace controller
32	Burner: Fan has short-circuited	• Check power voltage • Check if fan wheel is binding • Replace burner controller	84	Burner: Fan speed has not been detected	• Check if power voltage is too low
33	Burner: Fan Speed too low				• Check if fan wheel is binding • Replace burner controller
Burner: Communication Failure					
41	Burner: Circulation pump absent/ broken circuit	• Check pump wiring • Replace circulation pump	91	Burner: Crystal failed in the controller (crystal oscillator is the "heartbeat generator")	• Check burner harness & connections • Ensure terminals are making contact and wires are in place • Replace burner harness or burner connector if damage is found • Replace controller
42	Burner: Circulation pump short circuit				
47	Burner: Fuel Pump Failure Fuel pump short-circuit	• Check fuel pump wiring/connections • Replace fuel pump • Replace controller	E0	Burner: Signal at start-up was not detected	
48	Burner: Fuel Pump Failure Fuel pump absent/broken circuit		E1	Burner: Controller fault	
			E2	Burner: Glow Plug measurement circuit fault	

General Failure Symptoms of the Burner

This section will cover the typical failures of the diesel burner. Refer to the table more fails and their remedies.

Failure Symptom	Possible Cause	Remedy
Burner switches off automatically (fault lockout)	No combustion after start or automatic repeat start	Switch off burner and switch back on.
	Flame extinguishes during operation	<ul style="list-style-type: none"> Check coolant lines for obstructions, closed valves, and kinks. Check coolant level, purge any air. Allow burner to cool down. Check for failure codes.
	Burner overheats	<ul style="list-style-type: none"> Charge/replace batteries. Switch off burner and switch back on.
Heater is letting out black smoke from the exhaust	Combustion air and/or exhaust tube is blocked	Check combustion air intake and or/ exhaust tube.
Burner does not switch on	Heater is without electrical power	Check power supply to the unit and ground connections.
Burner switches off during operation (= fault lock-out)	Burner has overheated due to lack of coolant	Refill antifreeze and water mixture.

Service of the Burner

The service or maintenance should be done once a year to maintain the functional reliability of the burner. The service and any repairs must only be performed by trained technicians.

Proper preventive maintenance greatly improves the burner performance.

- Visual inspection of the burner for any external damage, fastening, and also external cleaning (make sure power is disconnected before any cleaning).
- Inspect electrical connections for corrosion, making sure they are all properly secured and free of any kinks, cracks, or damage.
- Check the exhaust and combustion air lines for signs of damage and make sure they are clear of debris or any blockages.
- Check fuel lines for any leaks, kinks, cracks, or damage.
- Check plumbing lines and circulation pump to make sure they are properly secured and free of any damage.
- Check the fuel pump and circulation pump for any damage.
- Run the burner for 20 minutes once a month.
- Clean the burner of any debris or dust with compressed air.
- Replace the fuel filter once a year, or after extended period of non-use.



Figure 103

System Checks

Please do the following checks prior to the first operation to confirm the installation was done properly and safely.

1. Confirm that the Aqua-Hot 125-DN2 is fully and properly installed. It must be adequately filled of fluid and purged of any excess air.
2. Confirm the burner is properly and securely mounted, all bracket fasteners are tightened.
3. Confirm that there is ample space between the burner and any heat-generating parts such as the exhaust.
4. Confirm that there is ample space between the burner and any moving vehicle parts during all system operations.
5. Make sure the burner is installed in location that is free from any splashing water or debris, and protected from other components installed in the same compartment.
6. There should be substantial separation from the burner and the ground.
7. There should be enough space between the vehicle body and any heat-generating components like the exhaust and burner.
8. Ensure there is protection on any sharp edges or objects.
9. Confirm that all of the plumbing and fuel lines are free from any kinks or sharp bends, and are not pinched or could be potentially cut.
10. Make sure all the hose clamps are properly positioned and secured.
11. Ensure that there is an adequate amount of fluid in the system, and it has been purged of any air.
12. Make sure there is more than a ¼ tank of fuel and the operating voltage is greater than 11.5V.
13. Confirm that the plumbing lines leading from the burner to the 125-DN2 are below the expansion bottle.
14. Ensure that all wiring is properly secured and away from any moving parts or heat sources.
15. Make sure the power and ground connections are properly secured and installed.
16. Check all plumbing connections for leaks.
17. Check that the fuses are in their proper, specified locations.
18. Make sure the fuse boxes are secure and protected from any water sources.
19. Ensure the vehicle battery is mounted properly and all connections are secure, and has a full charge.
20. Make sure the fuel standpipe is properly and securely mounted in the fuel tank.
21. The standpipe should not interfere with the vehicle fuel delivery system. Check the fuel gauge for proper operation.
22. Confirm all fuel lines are secured and spaced safely away from exhaust or other heat-generating components.
23. Make sure the fuel pump is installed in a cool place. It is recommended to install the fuel pump in the same location as the vehicle fuel tank.
24. Make sure the exhaust and clamps are properly secured.
25. The exhaust tube should be a safe distance from any flammable materials (at least 2in / 50mm).
26. Confirm there are holes drilled in any low points in the exhaust tube.
27. Exhaust opening should be a safe distance away from any vehicle interior openings and should be directed to not cause back pressure while driving.
28. The combustion air intake should get fresh air away from the direction of travel.
29. Ensure the air intake system is properly secured.
30. All plumbing and fuel lines should be purged of any air, as any air can cause a system lock-out.

NOTE: The burner must not be started until it has been properly checked by a professional technician. The burner must be installed professionally in accordance to the installation instructions - see burner checks below.

Please do the following checks prior to the first operation to confirm the burner installation was done properly and safely.

- Make sure the fluid temperature is below 122°F.
- Check all connections for leaks.
- CO₂ settings should be set to factory settings.
- Refer to the troubleshooting procedure if the burner switches to fault lock-out condition.

Once the system checks are complete and it has been confirmed that all is properly and safely installed, please continue to the first operation section.



WARNING

Never operate the burner in closed rooms such as garages or workshops that do not have proper ventilation. Please be sure to confirm all the system checks prior to the first operation.

Aqua-Hot First Operation

Activation Instructions (Electric Element):

1. Make sure power supply to the Aqua-Hot is on.
2. Confirm that the ethylene glycol and distilled water heating solution is adequately filled.
3. Confirm the system and heating loop has been properly purged of any air.
4. Make sure to flush the domestic water system thoroughly with clean water prior to use.
5. Tap the electric element to "ON" on the Aqua-Hot 3.5in LCD screen to supply the 120V AC electric element with power.

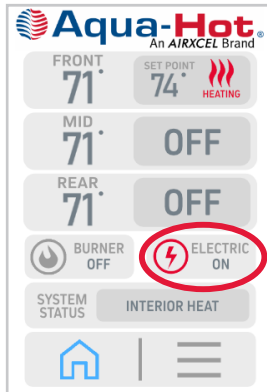

Figure 104

6. Allow approximately 20 minutes for the electric element to heat the tank. Turn on a hot water faucet, and allow to run until hot water flows. Once there is hot water, close the faucet. This will verify that the electric element is operating as it should.

Once these checks have been confirmed, the electric heating element is now ready for normal operation and use.

Continue to the next procedure to activate the external diesel burner.

<p>LDE-200-810</p>	<h1 style="margin: 0;">WARNING</h1>
	<p>Burn Hazard</p> <p>Hot Coolant Circuit with Hot Surfaces can cause severe burns.</p> <p>DO NOT touch or service until equipment has cooled.</p>

The first operation of the burner with the Aqua-Hot may not light up perfectly. It may take 5-6 starts for the burner to ignite for the first start-up after installation, because the fuel pump needs to fill the fuel lines leading to the burner for ignition.

NOTE: Make sure to perform the fuel line purge procedure on Page 43 prior to starting this initial start up of the burner.

Activation Instructions (Diesel Burner)

1. Make sure there are no blockages or debris to the exhaust outlet or combustion air inlet.
2. Make sure the plumbing lines and fuel lines are properly purged and free of air.
3. Make sure there is adequate fuel in the vehicle fuel tank (at the least ¼ tank).
4. Turn on the burner on the heater control screen.

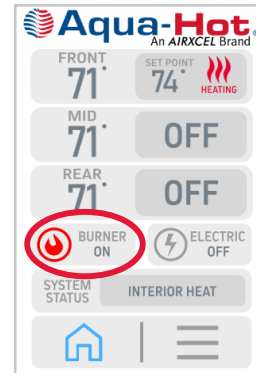

Figure 105

5. Once the burner turns on, the circulation pump and combustion air fan should run (can be determined by listening).
6. The burner should start up after approximately 120 seconds. This can be determined by the hot exhaust exiting from the exhaust tube.
7. Allow the burner to run a full cycle. Turn on the heat or hot water inside the RV to confirm the burner is properly operating.

Once these checks have been confirmed, the diesel burner is now ready for normal operation and use.

NOTE: It is recommended to run the burner for at least 20 minutes every month to ensure optimum heater condition.

NOTE: Both the electric heating element and the external diesel burner are thermostatically controlled. The element and/or burner will automatically maintain the temperature of the boiler tank's antifreeze and water heating solution.

Winterizing the Aqua-Hot

The Aqua-Hot's domestic water heating system must be completely drained of domestic water at any time the heater is stored where freezing temperatures may be experienced.

Please follow these instructions when winterizing the Aqua-Hot domestic water heating system. Reference Figure 106 for a system overview.

NOTE: The Aqua-Hot can continue to be used for interior heat once the domestic hot water system has been winterized.

1. Completely drain the fresh water storage tank.
2. Disconnect the domestic water demand pump suction line from the fresh water storage tank.
3. Attach an adequate piece of hose onto the suction side of the domestic water demand pump.
4. Place the opposite end of the hose into an adequate supply of non-toxic RV winterization antifreeze (FDA certified as "GRAS" Generally Recognized As Safe must be used) and allow the fluid to pump through.
5. Open and close all interior and exterior water faucets one at a time, until ONLY pure RV antifreeze is present. Perform this procedure for both cold and hot water faucets.
6. Remove the hose and reconnect the domestic water demand pump's suction line to the fresh water storage tank.



WARNING

Not winterizing the Aqua-Hot when freezing temperatures are present will result in serious damage to the Aqua-Hot domestic water heating system. Ensure that only non-toxic RV antifreeze (FDA approved "GRAS" antifreeze) rated for winterization is used when winterizing this unit. The warranty does not cover freeze damage.

NOTICE

Disinfecting the Domestic Water System

The Aqua-Hot Heating components are not compatible to prolonged exposure to sodium hypochlorite (bleach or liquid bleach). Using products containing bleach, including water refreshers, may cause corrosion of the domestic water lines, resulting in a catastrophic failure of the Aqua-Hot system by creating leaks that cannot be repaired. This damage is not covered by the Aqua-Hot warranty.

If disinfecting the hot water system, be sure to follow NFPA 1192 Standard of Recreational Vehicles "Instructions for Disinfection of Potable Water Systems" or any other applicable local standards for Potable Water Systems.

NOTE: Extended exposure to household bleach will corrode the components of the Aqua-Hot will potentially dramatically shorten the operational lifetime of the Aqua-Hot. Under no circumstances is the Aqua-Hot to be exposed to household bleach for extended periods of time.

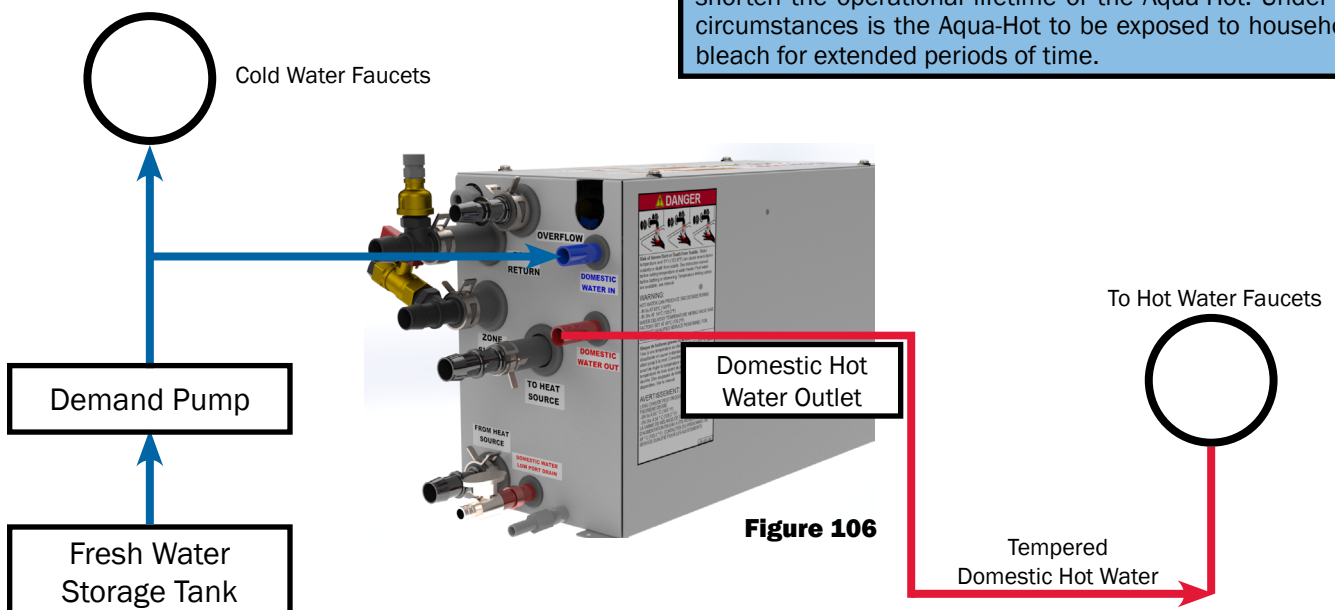
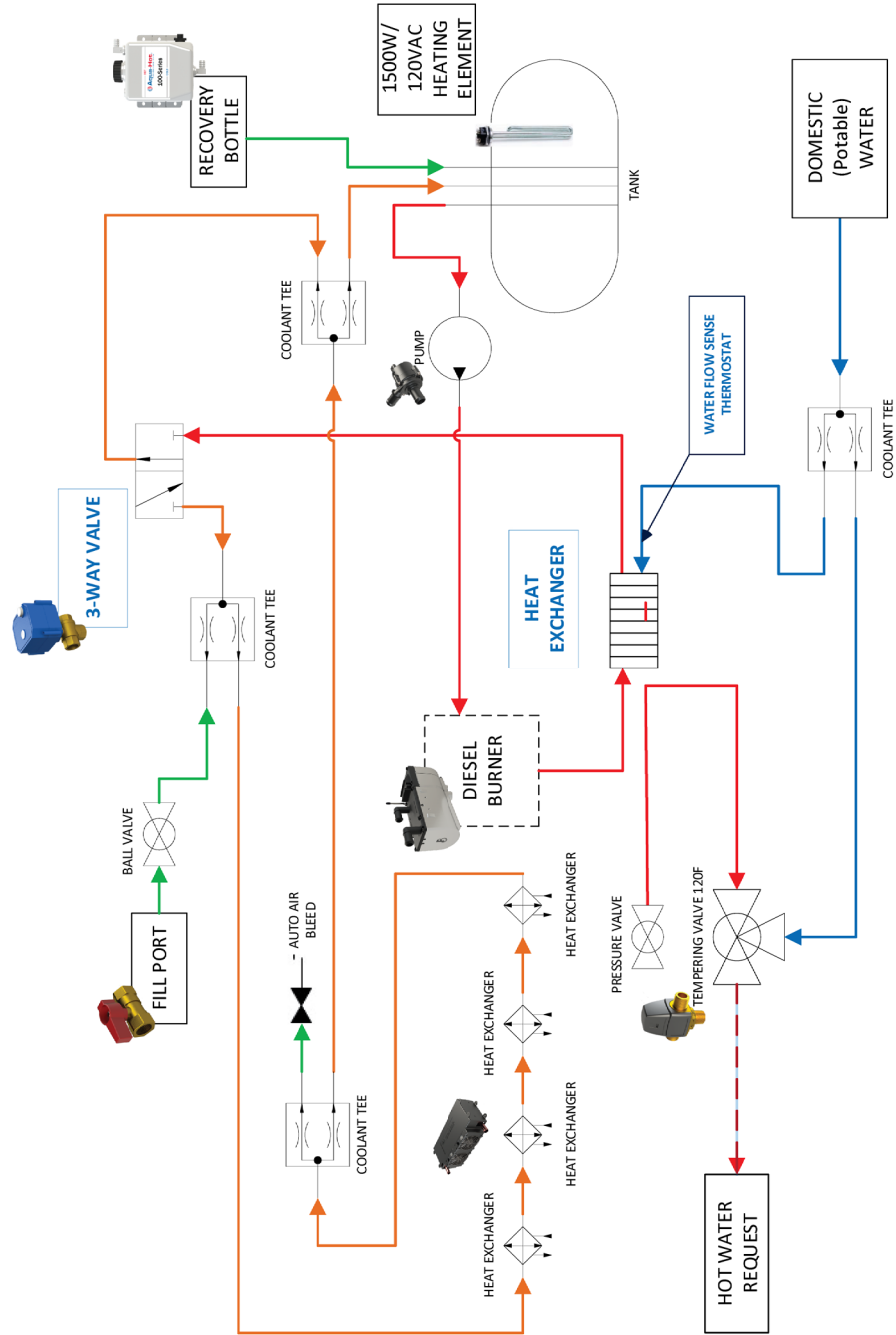

Figure 106

AH100 Series



With Standard 1.5kW / 120VAC Tank Heater and Diesel Burner



3-Way Valve Controls Coolant Flow Path For Interior or Hot Water Heating
 Interior Heat: Orange Path.
 Hot Water: Blue Path

During Interior Heat Operation when Domestic Water Flow is detected, the 3-Way Valve will switch automatically providing all heating power for heating the water.

PIN OUT INFORMATION

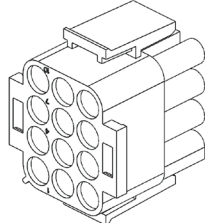
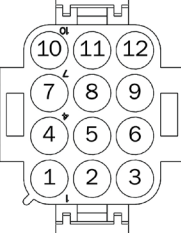
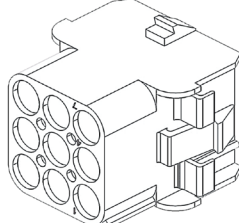
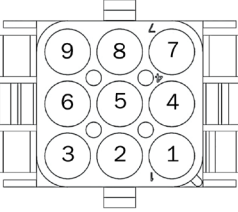
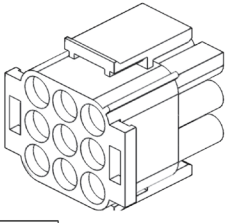
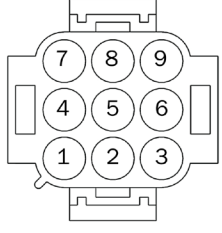
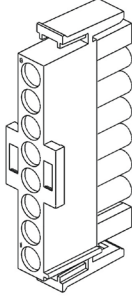
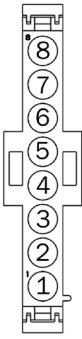
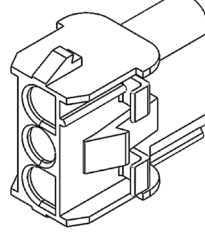
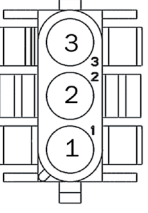
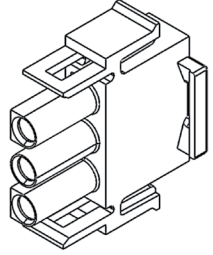
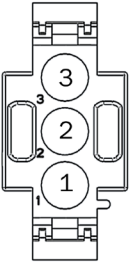
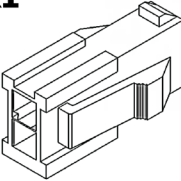
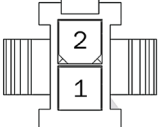
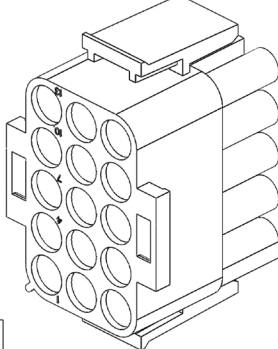
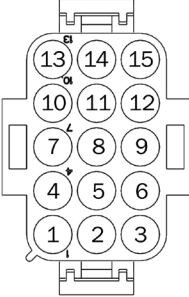
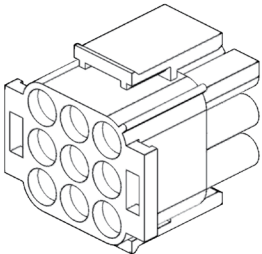
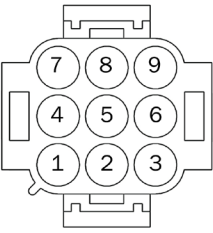
<p>J6</p>   <ul style="list-style-type: none"> 1 - ELECTRIC OUTPUT 2 - ELECTRIC GND 3 - BURNER ON SIGNAL TO HIGH-LIMIT T-STAT 4 - SPARE 5 - SPARE 6 - SPARE 7 - PUMP OUTPUT 8 - PUMP GND 9 - BURNER STATUS INPUT FROM HEATER 10 - VALVE A OUTPUT 11 - VALVE B OUTPUT 12 - SPARE 	<p>J7</p>   <ul style="list-style-type: none"> 1 - FAN 1 OUTPUT 2 - FAN 2 OUTPUT 3 - FAN 3 OUTPUT 4 - FAN 1 GND 5 - FAN 2 GND 6 - FAN 3 GND 7 - BOOST PUMP OUTPUT 8 - BOOST PUMP GND 9 - INPUT BURNER STATUS 	<p>J7-M</p>  
<p>J4</p>   <ul style="list-style-type: none"> 1 - LTCO INPUT 2 - LTCO OUTPUT 3 - LLS INPUT 4 - LLS OUTPUT 5 - ETS THERMISTOR INPUT 6 - ETS THERMISTOR OUTPUT 7 - SPARE 8 - SPARE 	<p>X3</p>   <ul style="list-style-type: none"> 1 - ON / OFF 2 - GROUND 3 - INPUT BURNER STATUS 	<p>X3 MATE FOR REFERENCE</p>  
<p>X1</p>   <p>TO MIXING VALVE</p>	<p>J8</p>   <ul style="list-style-type: none"> 1 - ZONE 1 INPUT FROM THERMISTOR/THERMOSTAT 2 - ZONE 1 OUTPUT TO THERMISTOR/THERMOSTAT 3 - SPARE 4 - ZONE 2 INPUT FROM THERMISTOR/THERMOSTAT 5 - ZONE 2 OUTPUT TO THERMISTOR/THERMOSTAT 6 - SPARE 7 - ZONE 3 INPUT FROM THERMISTOR/THERMOSTAT 8 - ZONE 3 OUTPUT TO THERMISTOR/THERMOSTAT 9 - HOUSE POWER SENSE <p>J8 END A</p>	<p>J8-B</p>   <p>J8 END B</p>

NOTE: All connectors are shown from Pin insertion side.

MATE-N-LOCK			MATE-N-LOCK		
CONNECTOR	MATE PART #	FLAMMABILITY RATING	CONNECTOR	SOCKET PART #	WIRE SIZE RANGE (AWG)
J4	640582-1	UL94V-0	J4	350550-1	20-14
J6	1-480708-0	UL94V-2	J6	350550-1	20-14
J7	1-480706-0	UL94V-2	J7	350550-1	20-14
J8	1-480710-0	UL94V-2	J8	350550-1	20-14

ZONE HEAT EXCHANGERS & ZONE THERMOSTATS

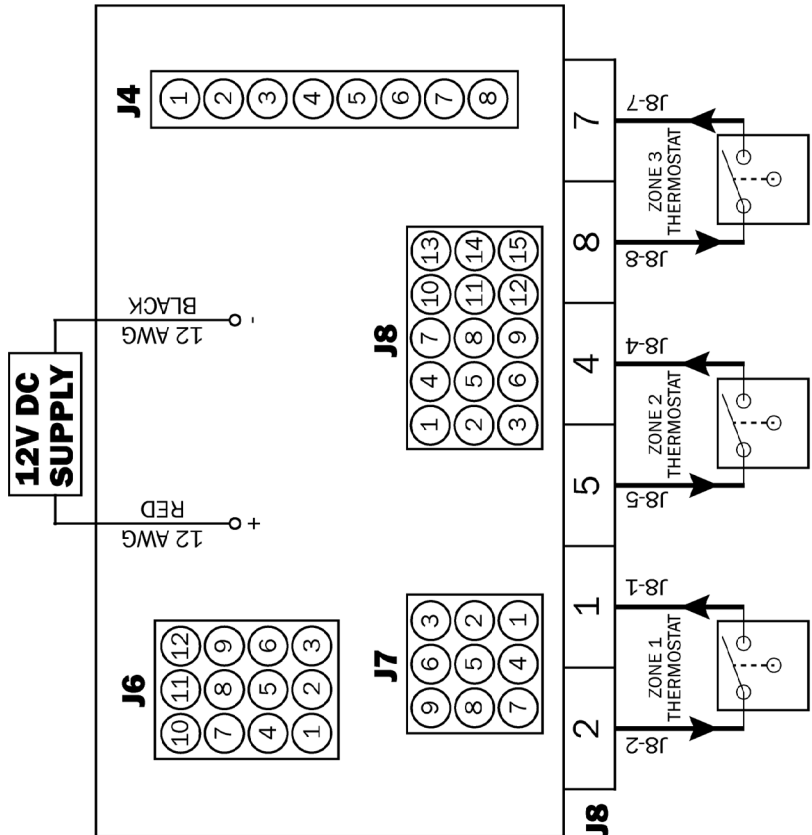
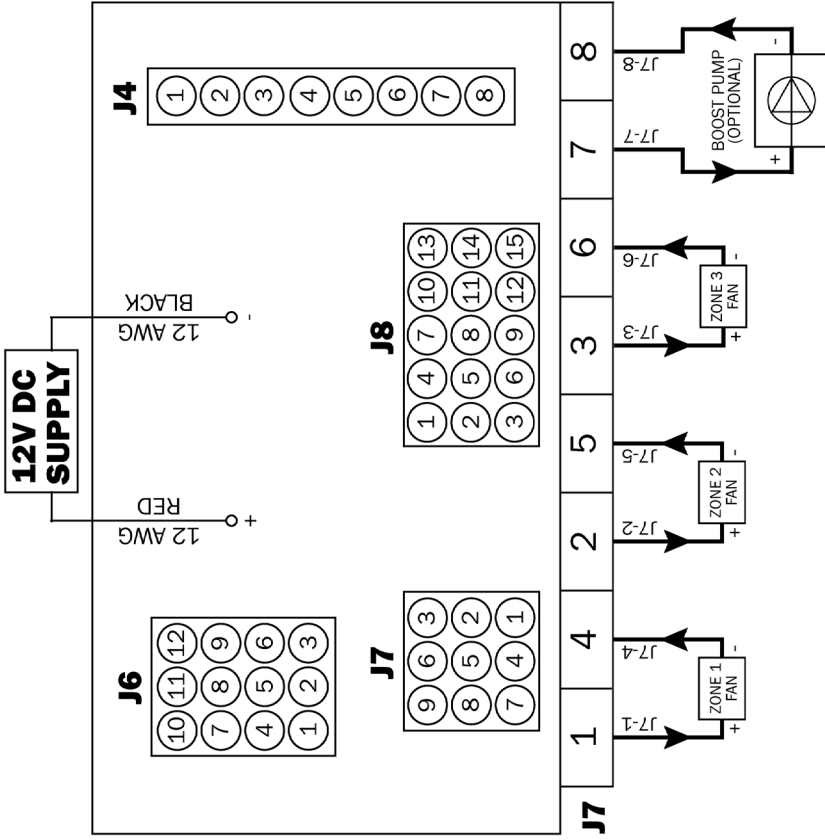

EXTERNAL DIESEL BURNER

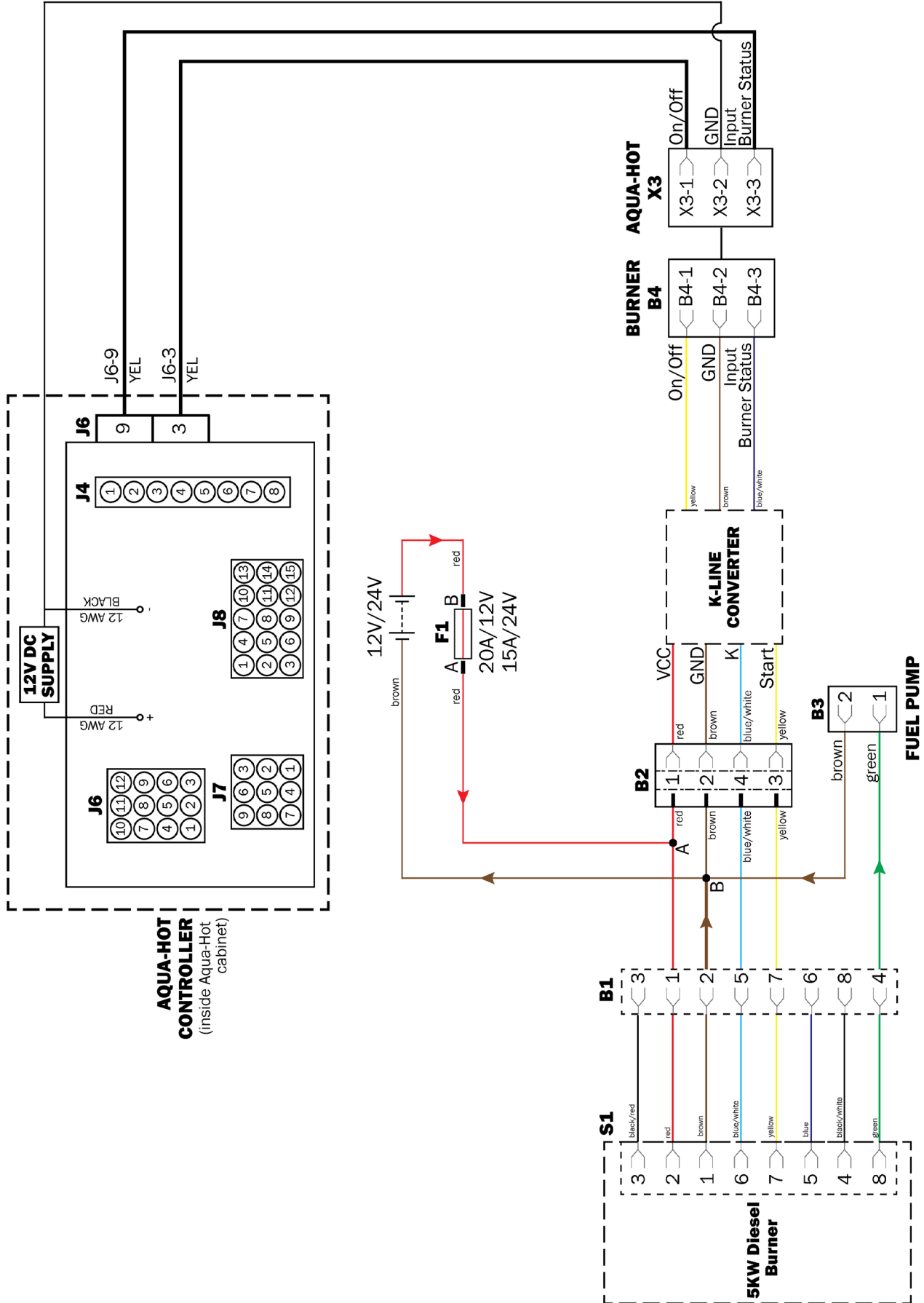

SENSORS, THERMOSTATS, ELECTRIC ELEMENT

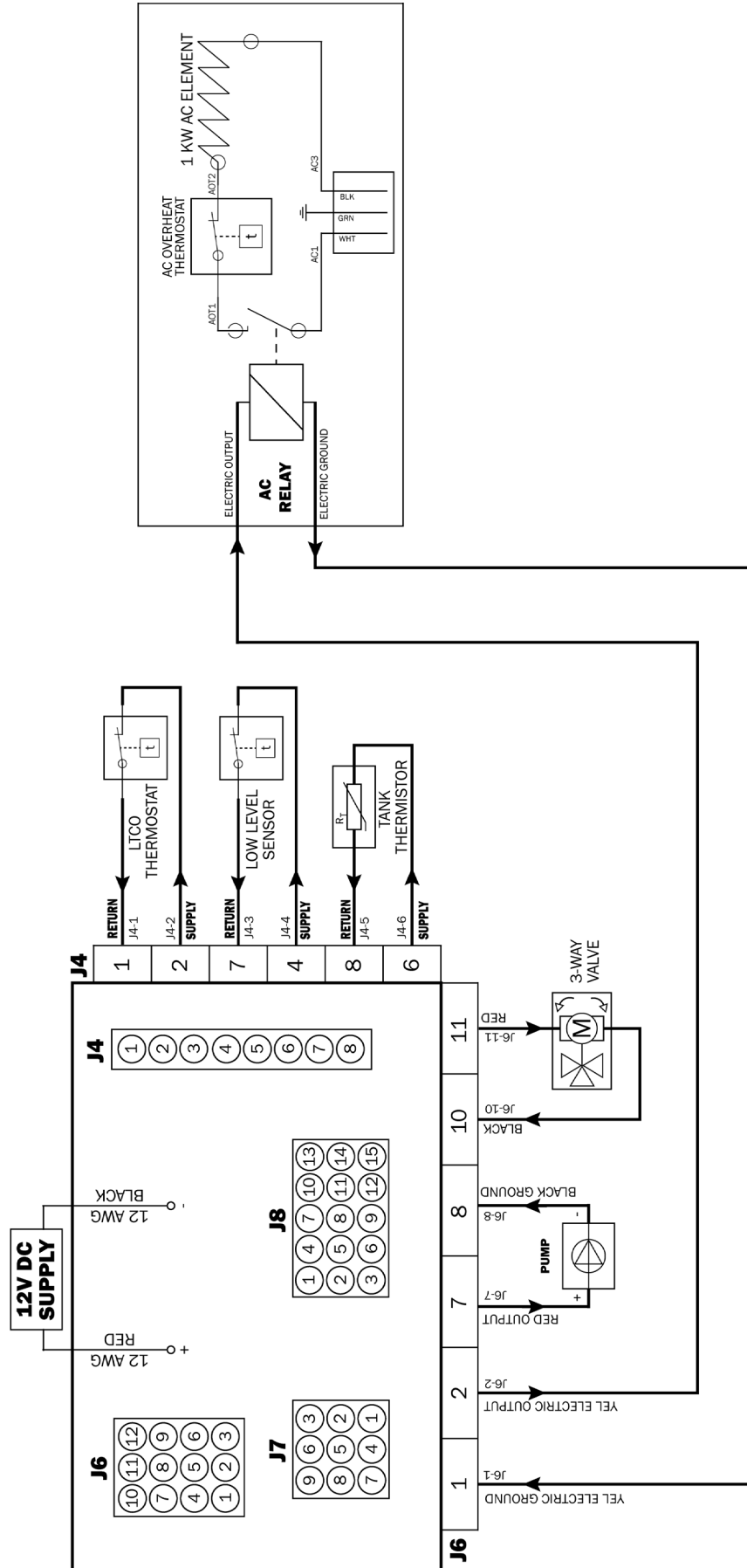

Measuring Antifreeze Using a Refractometer

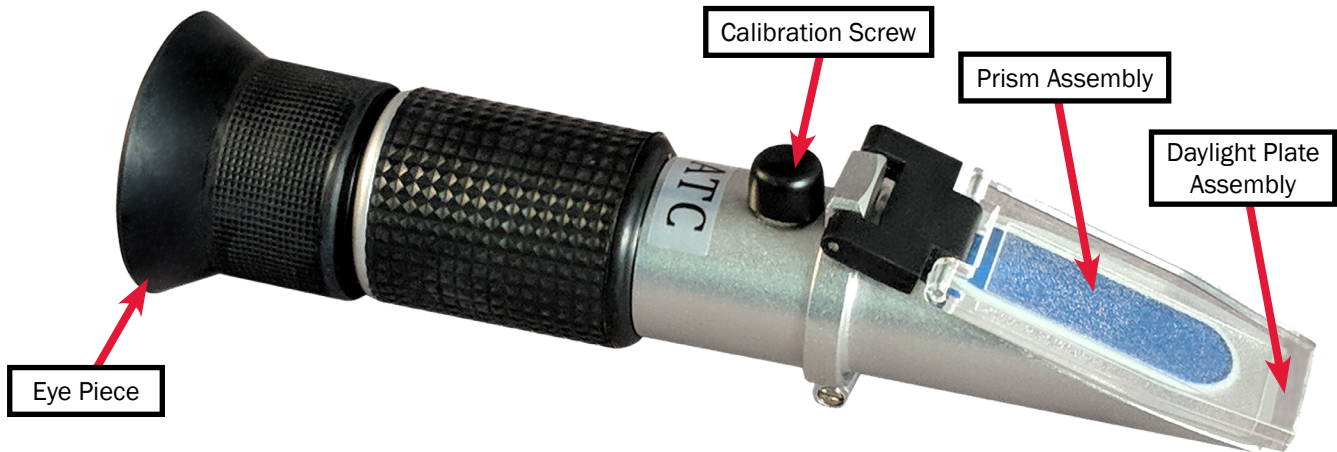

Properly Apply Antifreeze to the Prism Assembly

Use the guide below to properly apply the ethylene glycol mixture to the prism assembly of the refractometer. Once that is complete, peer through the eyeglass of the refractometer to continue to the next step.

Adjust the Boundary Line

Once the glycol solution has been properly applied, adjust the calibration screw until the boundary line labeled “Ethylene Glycol” is set to 32 ° F. The graphic to the right has been designed as an aid, but note that it may differ from what is shown in the refractometer sight glass.

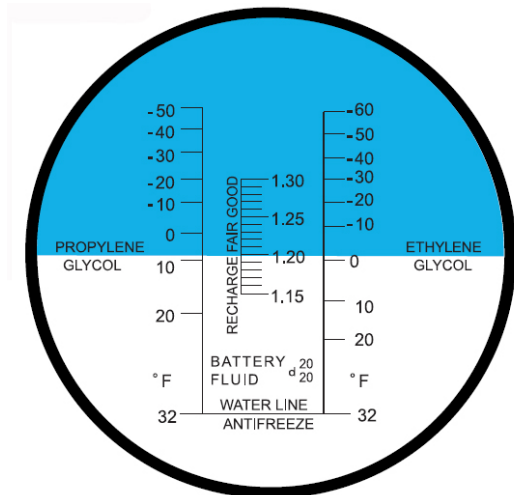

Application of Ethylene Glycol

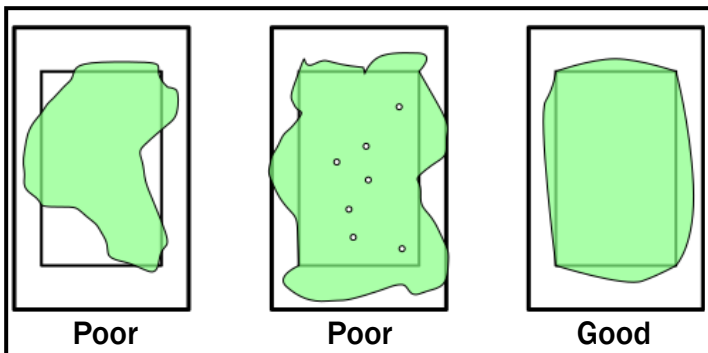

Refractometer Sight Glass

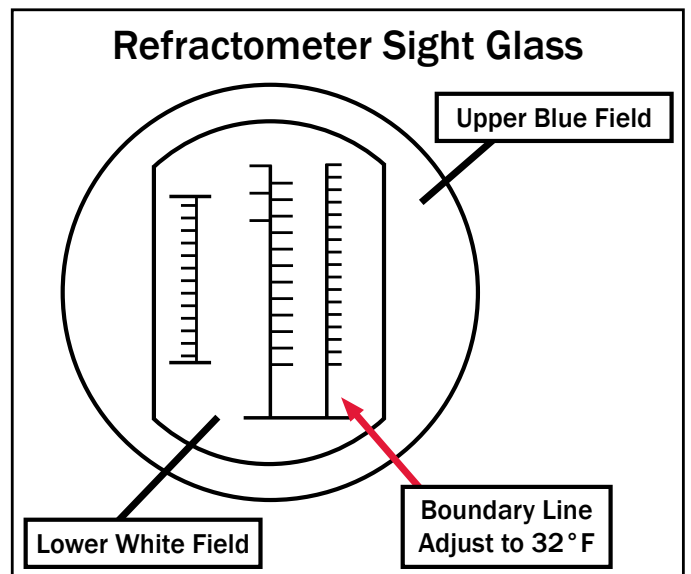



[AHE-125-DN2](#)

100 Series Diesel with Electric Element (1500W / 120V AC)

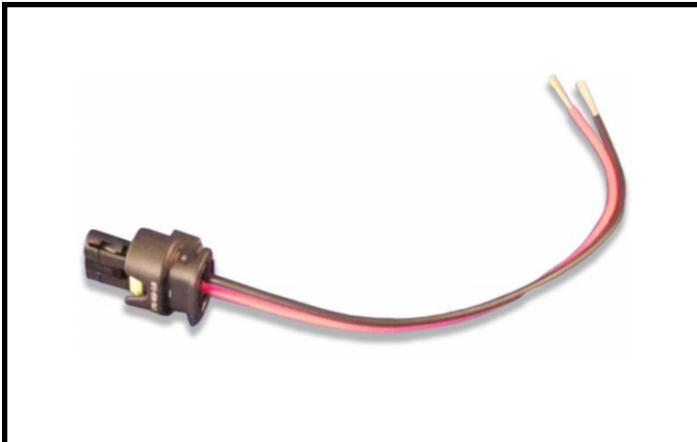

[ELE-400-900](#)

Boost Pump Harness



[ELX-THM-309](#)

Thermistor, 10K NTC, Room Temperature Sensor



[ELX-700-007](#)

Room Thermostat, Positive Off



[EXE-103-OEX](#)

Heat Exchanger, Cozy III



[EXE-505-65A](#)

Heat Exchanger, Whisper Silent, 12V DC.



[EXX-006-500](#)

Grille, Long, 3.5" x 21.5", Black

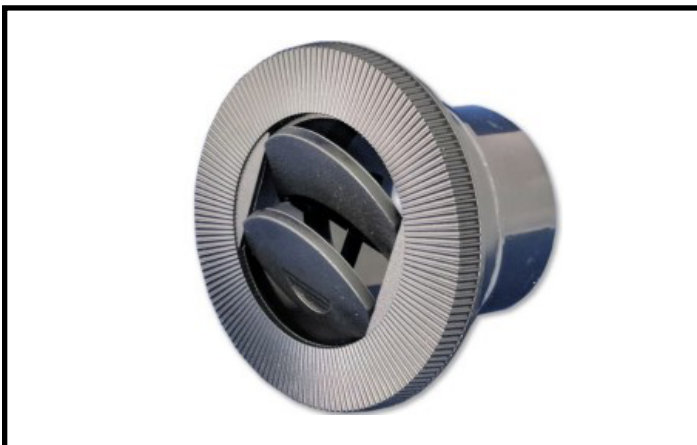

[EXX-013-100](#)

Nozzle, Round 4" w/o Connector, Black



[EXX-013-105](#)

Nozzle, 4" Round w/ 2-1/2" Connector, Black

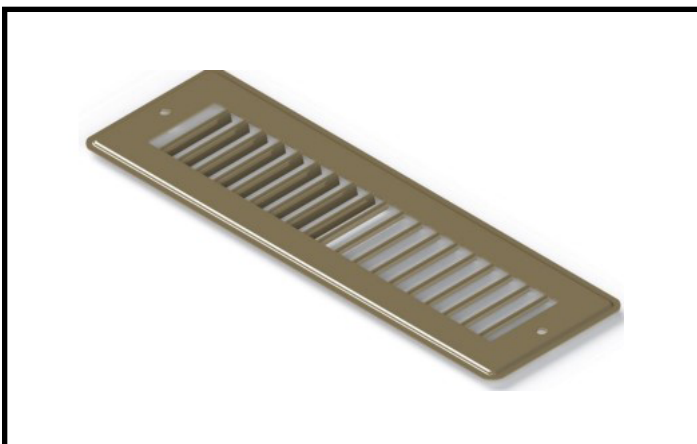

[EXX-950-411](#)

Grille, 10" x 2" Cozy



[EXX-006-501](#)

Grille, Medium, 3.5" x 15", Black



[ELE-125-200](#)
RV-Side Wire Harness (optional)



[PLX-000-200](#)
Tube, 5/8" Safety Stripe, 12ft.



[PLX-000-820](#)
Fitting, Elbow, 90°, 3/4", Barb, Black Nylon



[PLX-000-835](#)
Fitting, Reducer 3/4" to 5/8" Black Nylon



[PLX-100-900](#)
Boost Pump



[PLX-120-626](#)
Tube, 5/8", Red O2 Barrier PEX 100 Ft.



[PLX-200-103](#)

Fitting 1/2" (M) NPT x 3/4" Barb Black Nylon



[PLX-284-74V](#)

Hose, Molded, Elbow 90°



[PLX-432-000](#)

Fitting, Straight, 1/2" PEX x 1/2" (M) NPT PSF



[PLX-803-000](#)

Fitting, Straight, 1/2" PEX x 1/2" (F) NPT



[PLX-803-ELB](#)

Elbow Fitting, 90°, 1/2" PEX x 1/2" PSF



[PLX-803-FSE](#)

Elbow Fitting, 90°, 1/2" PEX Fitting



[PLX-CTB-270](#)

Clamp, Hose, Constant Tension, 0.75"



[PLX-A51-106](#)

Bend Support, 5/8"



[PLX-A65-200](#)

Fitting, Brass Barb, 3/4" x 1/2" (M) NPT



[PLX-A65-300](#)

Fitting, Brass Barb, 90°, 3/4" x 1/2" (M) NPT



[PLX-T44-006](#)

Fitting, Insert Modified Bras



[SME-102-000](#)

Cozy Plenum Assembly



Clamp Crimp Tool for Fuel Line Install
(Included with First Install Kit)



5kW Diesel Burner Fuel Kit
(Included with 125-DN2 Burner)



[ELE-102-111](#)

Clamp, (10.5mm), Soft Hose and Tube



[HDX-102-113](#)

Clamp, $\frac{3}{8}$ to $\frac{7}{16}$ (11.3mm), Soft Hose and Tube



[MSX-907-162](#)

Refractometer



AQUA-HOT™ (2) YEAR LIMITED WARRANTY

Aqua-Hot Heating Systems Inc. warrants the AQUA-HOT heater to the original owner to be free from defects in material and workmanship under normal conditions of designed usage and service as outlined in the installation and operator manuals for a period of two (2) years covering both parts and labor beginning on the date of purchase of the vehicle by the original owner. Replacement parts are covered for the remainder of the heating systems warranty. All purchased replacement parts will carry a six months, (180) days warranty.

This warranty does not apply to scheduled maintenances items such as fuel filters and fuel nozzles, damage or failure of the AQUA-HOT heater or the vehicle into which it was installed due to improper installation, assembly, maintenance, abuse, neglect, accident, or the use of parts not supplied by Aqua-Hot Heating Systems, Inc. Aqua-Hot Heating Systems is not responsible for incidental or consequential damages.

The intent of this warranty is to protect the end user of the heating system from such defects, which might have occurred in the manufacture of the product. The warranty is not intended to protect the end user from problems, which are outside the ability of Aqua-Hot Heating Systems control.

To obtain a warranty repair authorization or information, please contact the Tech Support Department at 1-800-685-4298 (7:00am to 4:00pm Mountain Standard Time).

My Comfort Zones are On-Board

Vehicle:

Purchased From:

Dealer Information:

Name:

Location:

Phone Number:

Heating System:

Serial Number:



Scan the QR code on the right with your mobile device to take you to the website to register your Aqua-Hot product.

Installation Manual

100_{SERIES}

 **Aqua-Hot**[®]
An AIRXCEL Brand



Aqua-Hot Heating Systems, LLC
7755 Miller Drive, Frederick, CO 80504

Visit us online at www.aquahot.com
Call us at (800) 685-4298 or (303) 651-5500

©2024 Aqua-Hot Heating Systems, LLC. Printed in the USA