

Service Manual

400 Series



AHE-450-DE5



Contents

Caution Notes.....1
 Introduction2
 Maintenance Schedule.....4
 System Features5
 Component Cut-Aways6
 Operational Flow Chart.....7
 Heating Solution.....8
 Measuring Antifreeze with Refractometer 10
 Interior Switch Controls11
 Exhaust System..... 13
 Interlock Switch.....14
 Fluid Level Sensor.....15
 ETS Module/Control Thermostat16
 AC High Limit Thermostat17
 DC High Limit Thermostats..... 18
 Low Temperature Cut-off Thermostat 19
 Check Valves 20
 Tempering Valve21
 Circulation Pumps 22
 Stir Pump/Circulation Pump #3.....24
 Engine Preheat Pump 25
 AC Electric Element.....27
 AC Relay 29
 Aqua-Hot Reporter..... 30
 Reporter Testing & Manual Mode 32
 Diesel Burner..... 34
 Diesel Burner Operation 40
 Detaching the Diesel Burner 44
 Reattaching the Diesel Burner47
Diesel Burner Components..... 50
 Motor..... 50
 Flame Sensor 54
 Ignition Electrodes 56
 Ignition Coil..... 58
 Fuel Nozzle 59
 Fuel Solenoid.....61
 Fuel Pump.....62
 Bearings..... 65
 Diesel Burner Controller 68
Troubleshooting..... 70
 Black Smoke..... 70
 White Smoke 71
 Lack of Heat 72
 Lack of Hot Water..... 73

Caution Notes

As you read this information, take particular note of the NOTICE, CAUTION, WARNING, and DANGER symbols when they appear. This information is important for safe and efficient use of the Aqua-Hot system.

NOTICE signals a situation where potential damage to the Aqua-Hot could occur.



CAUTION signals a situation where potential harm or risk of minor or moderate injury could occur if you do not follow instructions.



WARNING signals a hazardous situation where potential harm, risk of serious injury, or death could result if instructions are not followed.



DANGER signals a situation where immediate risk of serious injury or death will result if instructions are not followed.



NOTE: This manual will also use notes sections similar to this one to draw attention to features and practices which must be observed.

Antifreeze Leaking 74
 Wire Gauge Info..... 75
 Fuel Pressure.....77
 Cold Weather Operation 82
 Aqua-Hot Maintenance 83
 Winterizing the Aqua-Hot 95
 Filling the Aqua-Hot..... 96
 Purging/Draining the Aqua-Hot97
 Schematics 98
 Warranty 104

Introduction to this Document

Welcome to the Aqua-Hot 450D Service Manual. This manual will serve as a guide for diagnosing and repairing the Aqua-Hot, how to perform standard maintenance, and guide you through troubleshooting procedures to repair the Aqua-Hot. This service manual is designed to aid trained and qualified technicians to properly service and troubleshoot the Aqua-Hot 450D.

Each section in this manual is dedicated to the diagnosis of specific components within the Aqua-Hot which may be inhibiting the operation of the heater.

Troubleshooting and diagnosis of the Aqua-Hot is most efficiently and effectively accomplished with the Aqua-Hot Reporter, which will relay in plain-language, diagnosis of many Aqua-Hot related issues.

Aqua-Hot Reporter



Figure 1

If additional assistance is needed in diagnosing and repairing the Aqua-Hot, please contact our Technical Service Department at 574-AIR-XCEL (574-247-9235) from 7:00am to 4:00pm MST Monday through Friday.

NOTE: For networked control of the Reporter, Aqua-Hot requires system integrators ensure that individual commands are received and processed. Aqua-Hot requires that commands be repeated or confirmed so that if a single message were dropped, or if there is a brief network disturbance, the Reporter would get into the correct state as soon as the disruption was removed.

The Aqua-Hot Reporter monitors the heating system and handles all logic relating to safeties and heating control. As such, the system integrator is required to display all pertinent status information but not use that information to lock out operation or add additional safety layers that could impact the end of operation if a message from the Reporter was missed.



WARNING

If the information in this manual is not followed exactly, a fire may result, causing property damage, personal injury or death.

Read all instructions before servicing the Aqua-Hot unit. Aqua-Hot Heating Systems is not liable for damage resulting from failing to follow instructions contained in this manual, and any other Aqua-Hot documentation relevant to this unit.

- Read this manual before servicing the Aqua-Hot System to reduce the risk of injury to persons or damage to the equipment.
- The product identity label contains specifications of the unit, to what standards it has been tested, and important safety notices.
- Disconnect electric wiring to the Aqua-Hot System before welding or plasma cutting the coach to avoid damage to equipment.
- The Aqua-Hot tank and heating loop operate at 0 PSI (zero pressure system). Air pressure to the tank must not exceed 18 PSI. Exceeding this rating will cause internal damage to the Aqua-Hot.
- Use caution when working on or near any gas systems.



CAUTION

- DO NOT connect the 12-volt DC power to the Aqua-Hot if the vehicle requires welding.
- At maximum operating temperature, the coolant and vapor will be very hot and scalding that may result in serious burns or injury. Be aware of hot surfaces.
- Use special caution when children are present. Children must not be allowed to play with the heater or perform cleaning and/or maintenance.
- Installation and repairs may only be carried out by an authorized, factory-trained Aqua-Hot technician. The heating system must be serviced in accordance with local codes, or, in the absence of local codes, follow NFPA 1192. National safety regulations must be adhered to.



CAUTION

As with any appliance, allow the Aqua-Hot to completely shut down BEFORE disengaging the coach 12V power disconnect.

Aqua-Hot 450D

Introduction:

This service and parts manual is designed to aid trained and qualified service technicians with the process of troubleshooting and servicing the Aqua-Hot 450D Hydronic heating system.

About the Aqua-Hot:

The Aqua-Hot 450D heating system features a 12V DC powered diesel-burner and a 120VAC 1650 Watt electric heating element. These two heating sources are used in conjunction with an FDA-approved “GRAS” (Generally Recognized as Safe) **propylene glycol** based boiler antifreeze and water heating solution in order to provide a continuous supply of domestic hot water, interior/fresh water tank heating, independent interior zone heating, and engine preheating. Be sure to reference Figures 5 through 8 for a complete component overview.

Understanding the Aqua-Hot 450's Major Systems:

The basis for the Aqua-Hot heating system's functionality is the antifreeze and water heating solution, which is comprised of water that is distilled, deionized, or soft, as well as FDA-approved “GRAS” propylene glycol based boiler antifreeze. Through this solution's ability to maintain and transfer heat, the Aqua-Hot's three major systems: the domestic water system, engine preheat system, and interior heating system, are able to function effectively. This antifreeze and water heating solution is contained within the Aqua-Hot's boiler tank and is heated by the diesel-burner when its operating criteria are met and/or by the electric heating element when its operating criteria are met. In order for the diesel-burner to be considered as a heating source by the Aqua-Hot, it must have an adequate fuel supply, receive power from the Reporter, and be selected as a heating source from the interior switch panel. In order for the electric heating element to be considered as a heating source by the Aqua-Hot, it must receive power from either a generator or from shore power and be selected as a heating source from the interior switch panel. Once the antifreeze and water heating solution achieves operating temperature (as determined by the Aqua-Hot's control thermostat/ETS Module), the domestic water system, the engine preheat system, and the interior heating system are permitted to operate as needed.

Domestic Hot Water Priority System:

The Aqua-Hot 450D is a Hot Water Priority System. Meaning that the Aqua-Hot 450D cannot heat the interior of the motor home, and produce continuous hot water simultaneously. When

Domestic Hot Water is being used, the interior heating system will shut down, until no more Domestic Hot Water is called for.

The domestic hot water priority system is responsible for providing hot water whenever a hot water faucet is opened, such as with a shower or sink.

When hot water is requested, domestic water from the motor home's fresh water tank is transported through a copper coil in the Aqua-Hot's boiler tank where heat is transferred from the heated antifreeze and water heating solution to the domestic water flowing through the copper coil. The heated domestic water then flows through the tempering valve to be mixed with cool water from the fresh water tank to achieve an appropriate temperature before it flows to the faucet requesting hot water.

Engine Preheat System:

The engine preheat system is responsible for heating the motor home's engine block in order to make it easier to start-up when cool weather conditions exist.

When the engine preheat system is activated via the interior switch panel, the motor home's engine coolant is circulated through a dedicated copper coil in the Aqua-Hot's boiler tank, where heat from the antifreeze and water heating solution is transferred to the motor home's engine coolant. The heated engine coolant is then transported back to the engine where it transfers the heat to the engine to gradually warm it.

Additionally, the Aqua-Hot 450D includes a motor-aide feature, which uses the circulation of the motor home's engine to transport the engine's coolant from the Aqua-Hot's boiler tank to the motor home's warm engine and back to the boiler tank. Through this process, the boiler tank is kept heated, which reduces the time required to bring the tank to operating temperature for interior heat and continuous domestic hot water. This motor-aide feature is part of the engine preheating feature and plumbing system, and requires no action on the user's behalf to function.

Interior Heating System:

The interior heating system is responsible for providing heat to the motor home's interior in order to maintain the temperature at a comfortable level.

For interior heating, it is the room thermostats that trigger the Aqua-Hot's interior heating system. When a thermostat recognizes that heat is required in a particular area, it sends a signal to the Aqua-Hot's Reporter calling for heat. The Aqua-Hot responds by activating the circulation pump for that zone, which sends the heated antifreeze and water heating solution through the Heating Loop corresponding to the zone requesting heat. The fans on the heat exchangers in the zone calling for heat are also activated; therefore, as the heated solution flows over

the heat exchanger's fins, the heat is transferred to those fins and dispersed into the interior of the motor home by the fans. Until the thermostat signals that heat is no longer required, the Aqua-Hot will continue to send the heated antifreeze and water solution through the loop, which returns the cooled solution to the Aqua-Hot's boiler tank to be reheated before being sent back through the loop again. This process continues until the preset temperature of the interior is reached, and the interior room thermostat signals the Reporter that heat is no longer required.

AC Circuit:

Although the diesel-burner is the primary heating source for the Aqua-Hot and is necessary for providing continuous domestic hot water, an alternate heat source exists for moderate temperatures, which functions with an AC circuit. Whenever the motor home is connected to an AC power source, plugged into shore power or using a generator, the Aqua-Hot's electric heating element has the ability to function in order to provide heat for the boiler tank.

When the antifreeze and water heating solution falls below operating temperature (as determined by the control thermostat/ETS Module), a signal is sent to the Reporter requesting heat. Because the electric element switch is activated on the interior switch panel, the DC power from the Reporter is permitted to flow to the AC relay, which activates the relay in order to allow AC power to flow to the electric heating element. When the electric heating element receives power, it becomes active and supplies heat to the boiler tank until operating temperature is reached.



Figure 2

NOTE: Service parts and accessories are available through Aqua-Hot Factory Authorized Service Centers or at www.aquahot.com.

Maintenance Schedule

Monthly Maintenance

Check the Aqua-Hot's antifreeze and distilled water heating solution to ensure that it is at the proper level. This can be accomplished by visually checking the coolant level in the Aqua-Hot's expansion tank; reference Figure 140 on page 83.

Please note that the coolant level should be checked ONLY when the Aqua-Hot is at maximum operating temperature. This should be done immediately after the electric element disengages, or after the diesel-burner has completed a cycle.

At maximum operating temperature, the antifreeze and distilled water heating solution should be at the level marked "HOT" on the expansion tank.

The fluid concentration should be checked regularly to ensure the mixture is at 50/50 **propylene glycol** and distilled water.

Replenishing the Antifreeze and Water Heating Solution

If the antifreeze and distilled water heating solution needs replenishing, remove the cap for the expansion bottle and fill it to the "HOT" mark (only when the tank is to temperature). Replace the expansion bottle cap when this is complete. DO NOT operate the unit without first replacing the cap of the bottle. Reference Figure 140 for additional information. Excess air will escape through this bottle as the stir pump of the unit operates. While bleeding this system of air, it will be necessary to continue to fill the bottle until this process is complete.

Reference the Appendix on page 10 for the proper tool and instructions for usage in measuring the system's antifreeze mixture ratio.

The Aqua-Hot does not need regular replacement of the propylene glycol antifreeze and distilled water heating solution, but in the event that more antifreeze is required, contact Aqua-Hot Heating Systems to purchase antifreeze, or for guidance in selecting an appropriate antifreeze product for use with this unit.



DANGER

When the Aqua-Hot is at maximum operating temperature, the coolant is very hot. If the Aqua-Hot heating system is accessed, scalding by hot vapor or coolant may occur. Before cleaning or servicing, disconnect all power supplies.



For installation only in a compartment that is completely closed off from living quarters and accessible only from the outdoors. Exhaust system MUST NOT terminate beneath the vehicle and not less than 3 feet from an openable window. Combustion Air MUST BE supplied from outside the vehicle. THIS APPLIANCE OPERATES ON BOTH AC AND DC POWER. **USE COPPER CONDUCTORS ONLY!** Use a 25-Amp fuse for over-current protection for the DC power supply. Use a circuit breaker that cuts power at 20-Amps maximum for over-current protection for the 120-VAC power supply. Mount the Heater near a bay/storage door so that the Access cover can be easily removed for service.

For Detailed Information, reference the Owner's Manual or contact Aqua-Hot Heating Systems Inc. at 574-AIR-XCEL (574-247-9235.)

Minimum Heater Clearances
 Front - Open Access
 Back - 0 Inches
 Top - 0 Inches
 Sides - 0 Inches
 This appliance must be installed in accordance with local codes or, in the absence of local codes, the Standard for Recreational Vehicles, NFPA 1192 or CAN/CSA-Z240 RV.

For Direct Vent Installation in a Recreational Vehicle.
 Meets or Exceeds: UL 307A, UL 174
 CSA/CAN B140.0-03
 CAN/CSA-C22.2 No.110-94

Max Tank Pressure	0 PSI
Max Watts (DC)	174
Max Watts (AC)	1650
Nozzle Size/Angle	.35/60
Volts	12 VDC
Volts	120VAC, 60Hz
Pump Pressure	145 PSI / 10.0 bar
Input Firing Rate	56,000 BTU/hr / 16.4kW.
Diesel Burner Model	Webasto
Fuel Type	DIESEL

Diesel Burner Serial Number: 106642
 Model Number: AHE-450-DE5
 Heater Serial Number: A450D-1850005

7501 Miller Drive • Frederick, CO 80504 • 574-AIR-XCEL • www.aquahot.com

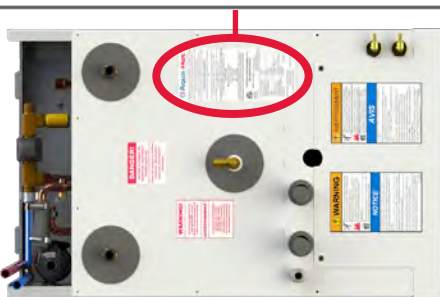

Figure 3

NOTE: This product label is attached to the top of the Aqua-Hot, and provides a ready reference to specifications, test standards, and important safety notices.



Figure 4

System Specifications

Diesel Burner

Heat Input (Firing Rate) 56,000 BTU/hr
 Fuel Consumption 0.40 gal/hr

Electric Element

Power Consumption 1650 W (maximum)
 Voltage 120V AC

DC Power

Consumption 174 W (maximum)

Zone Heat Circulation

Pumps 2
 Power Consumption (max)..... 21 W (each)
 Voltage 12V DC

Heating Zones

Maximum 5 + Engine Preheat

Domestic Water Heating

Maximum 1.5 GPM On-demand

Physical Specifications

Dimensions (US)..... 12" H x 18.5" W x 29.5" L
 Dry Weight 127lbs.
 Wet Weight..... 185lbs.

All vehicle installations must comply with the requirements listed in the Recreational Vehicle Industry Association's (RVIA) ANSI/NFPA 1192 Handbook for Recreational Vehicle Standards. To receive a copy of this handbook and other Pertinent RVIA Standards, write to: Recreation Vehicle Industry Association, 1896 Preston White Drive, PO Box 2999, Reston, VA 22090-0999. Call them at (703) 620-6003 or visit online at www.rvia.org.

Component Cut-Aways

- | | |
|-----------------------------|-------------------------------------|
| 1. Drain Valve | 14. Wiring Harness Port |
| 2. Zone 1 Circulation Pump | 15. Aqua-Hot Reporter |
| 3. Zone 2 Circulation Pump | 16. Heating Loop Coil |
| 4. Diesel Burner Controller | 17. Domestic Water Coil |
| 5. Combustion Air Sleeve | 18. Engine Preheat Outlet |
| 6. Diesel Burner | 19. Air Release Valve |
| 7. Diesel Fuel Lines | 20. Engine Preheat Circulation Pump |
| 8. Interlock Switch | 21. Engine Preheat Inlet |
| 9. VAC Access Panel | 22. Domestic Cold Water Inlet |
| 10. AC Terminal Block | 23. Domestic Hot Water Outlet |
| 11. AC Terminal Port | 24. Tempering Valve |
| 12. Heating Zone 1 Outlet | |
| 13. Heating Zone 2 Outlet | |



Figure 5

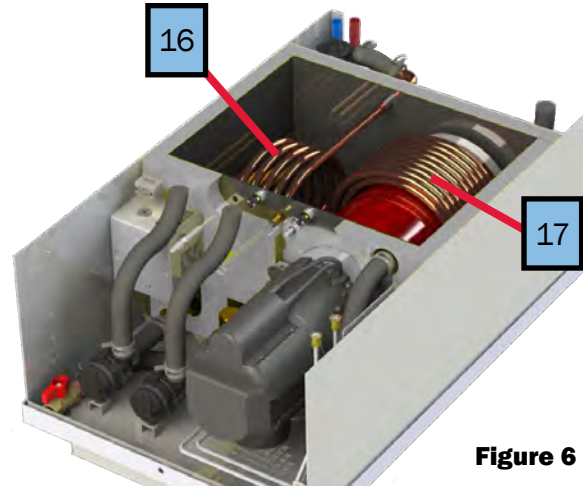

Figure 6

NOTE: The top panel has been made transparent in the view above to aid in the explanation of the heater. DO NOT remove the top panel. Doing so risks irreparable damage to the Aqua-Hot. Only remove the service panels.

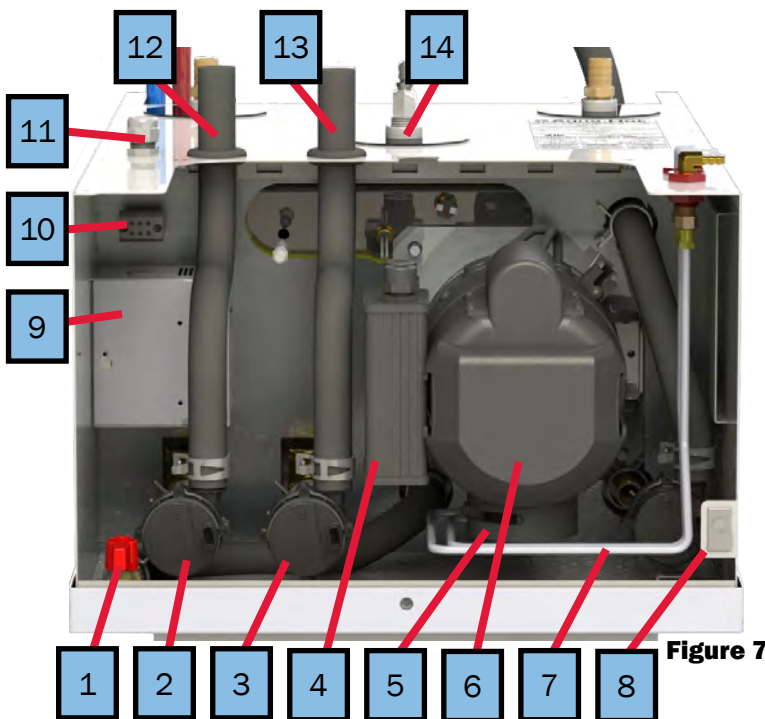

Figure 7

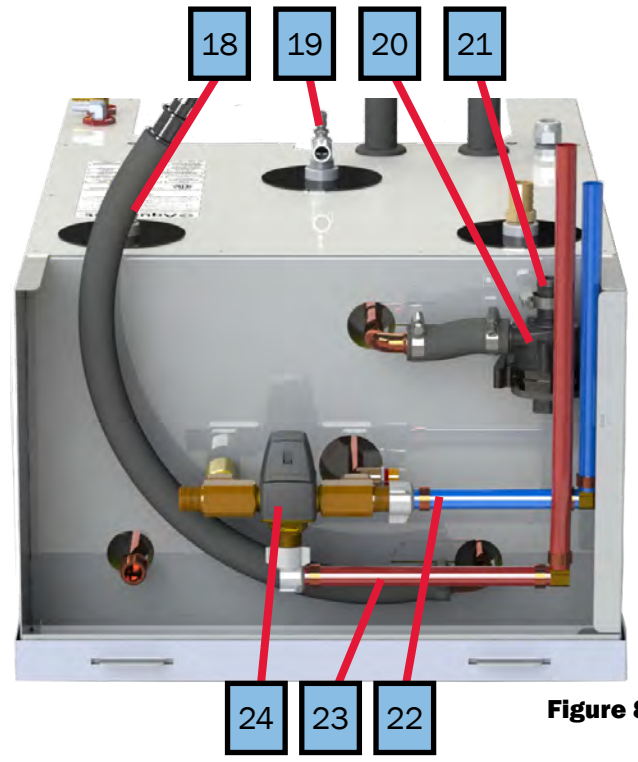
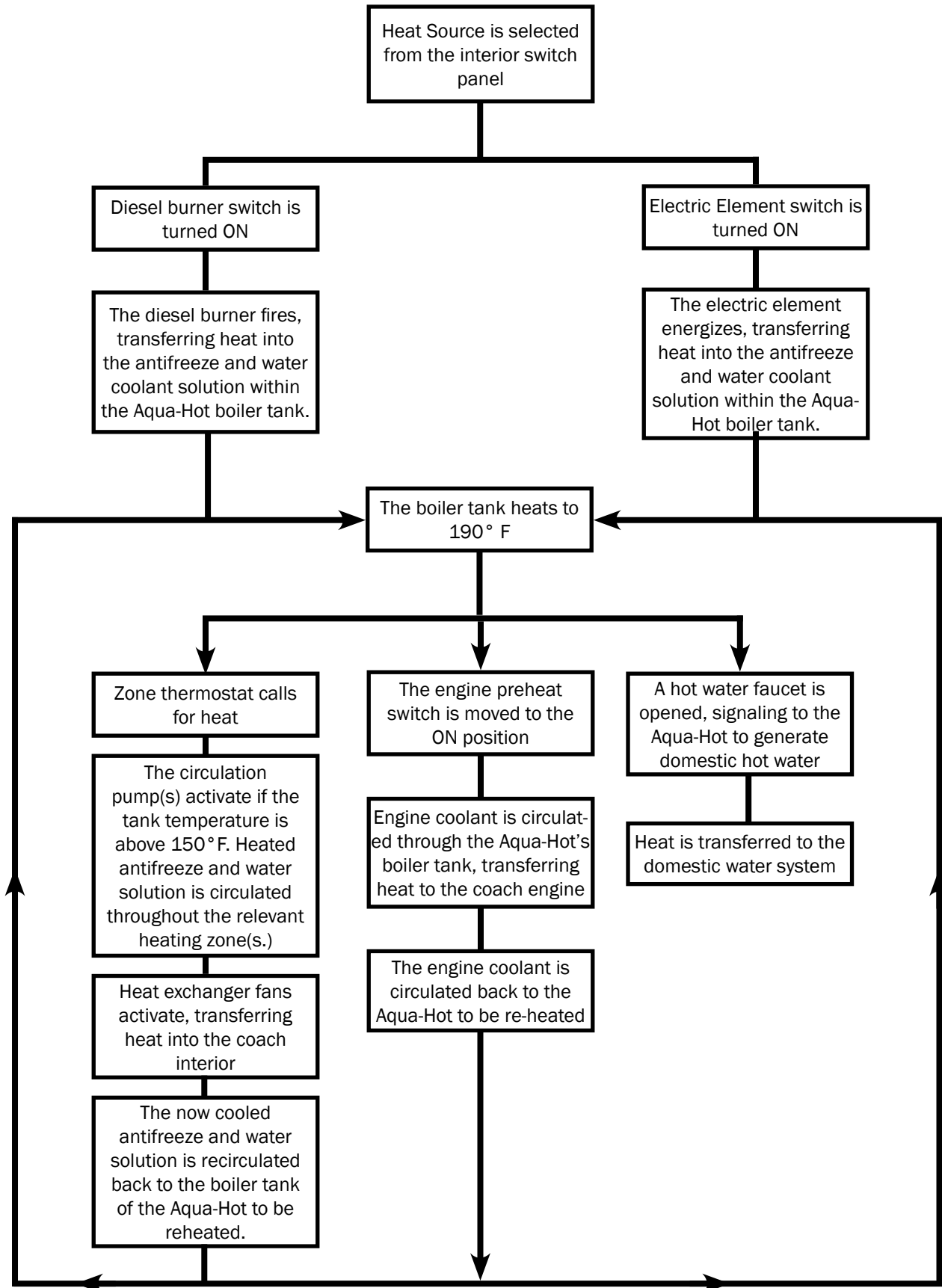

Figure 8

Operational Flow Chart



Antifreeze and Water Heating Solution

Introduction:

As the antifreeze type and mixture ratio is essential to the Aqua-Hot's performance and ability to comply with regulations, the following information is being supplied to understand various types of antifreeze, the quality of water necessary, and the mixture ratio. Aqua-Hot Heating Systems recommends Century Transfer Fluid.

Antifreeze Types:

The following information addresses the necessary usage of a propylene glycol based "boiler" type antifreeze in the Aqua-Hot. Propylene glycol is a safer alternative to the more toxic ethylene glycol antifreeze; however, as mandated by IAPMO (International Association of Plumbing and Mechanical Officials), only those propylene glycol based "boiler" type antifreezes deemed "Generally Recognized as Safe" (GRAS) by the FDA should be utilized.

Because of the significant impact various types of antifreeze can have on a Hydronic heating system, including the level of safety provided, it has been recognized that there is a need to provide an explanation regarding two additional prominent types of antifreeze/coolant available. The following information should be utilized as an educational means of ensuring that the proper type of propylene glycol based anti-freeze is selected.

RV and Marine Antifreeze:

These types of propylene glycol based antifreeze products are formulated specifically for "winterizing" applications only. Although RV & Marine antifreeze is often "Generally Recognized as Safe" by the FDA, it should never be used in the Aqua-Hot's Hydronic Heating System. This type of anti-freeze is not formulated to transfer heat, which is essential to the heating system's functionality and does not contain rust inhibitors. Please note, however, that RV & Marine anti-freeze can be utilized to winterize the Aqua-Hot's domestic water heating system.

Automotive Antifreeze/Coolant:

These types of propylene glycol based antifreeze products are formulated specifically to protect automotive engines against corrosion, freezing temperatures, and overheating. They also have excellent heat transfer and thermal conductivity characteristics. Although these types of antifreeze products are considered less toxic and safer than ethylene glycol for people, pets, and the environment, they are not "Generally Recognized as Safe" (GRAS) rated by the FDA. Therefore, they must be

marked with a "harmful if swallowed" warning. This additional warning is required because these types of antifreeze products contain high levels of chemical inhibitors. Due to their potentially hazardous properties, they should never be used in the Aqua-Hot's Hydronic Heating System.

Antifreeze Mixture Water Quality:

In order to ensure maximum performance and longevity of an Aqua-Hot heating system's boiler tank and associated components, it has been determined that there is a need to use distilled, deionized, or soft water in combination with concentrated propylene glycol for the Aqua-Hot's antifreeze and water heating solution,. Please note that this is only necessary when mixing concentrated propylene glycol antifreeze with water; suppliers of premixed antifreeze are responsible for the use of high quality (distilled, deionized, or soft) water when preparing their antifreeze for sale.

Hard water possesses a high-level of calcium and magnesium ions, which deplete the propylene glycol antifreeze's corrosion inhibitors. This, in turn, causes the antifreeze and water heating solution to begin turning acidic, which can corrode the Aqua-Hot's boiler tank and associated components prematurely. Therefore, concentrated propylene glycol should be diluted with distilled, deionized, or soft water that is 80 PPM or less in total hardness. The local water agency should have up-to-date water quality reports that should indicate if the local tap water is within this guideline.

Antifreeze Terms and Mixture Ratio:

The following information addresses the process of selecting an antifreeze and water mixture ratio that provides adequate freeze, boiling, and rust/anti-corrosive protection. A 50/50 mixture of propylene glycol/water ratio is recommended, which will result in a freeze point of approximately -28°F and a boil point of approximately 222°F.

The following information should be utilized for the purpose of clarifying some terms commonly associated with antifreeze.

Freeze Point and Burst Point:

Antifreeze lowers the freezing point of any liquid, to which it has been added, by preventing the formation of ice crystals; however, as the ambient temperature continues to decline, the water in the solution will attempt to attain a solid state. The point in which the water begins to solidify is termed the "Freeze Point." Although the water in the solution has begun to freeze, producing a "slushy" consistency, the anti-freeze in the solution will continue to combat the normal expansion of the solution as it freezes. The point in which the

solution can begin to expand, due to colder temperatures, is called the “burst point.” Once the solution reaches the burst point, the potential is present for ruptured pipes to exist. The burst point of the antifreeze and water heating solution is dependent upon the brand of propylene glycol employed.

Boiling Point:

The Aqua-Hot utilizes the antifreeze and water heating solution as a transportation means for the heat produced from the internal processes. The antifreeze absorbs the heat created until its boiling point is reached; it is at this point that the liquid turns to a gas and is expelled to prevent the heating system from overheating. Each time the boiling point is reached, a loss of efficiency occurs because the heat produced is expelled rather than used for the function of the heating system. Therefore, a higher boiling point is desired in order to combat the loss of efficiency, which allows the antifreeze to transport the heat created from the internal process throughout the motor home where it can be used productively rather than dissipating due to its change from a liquid to a gas.

Rust and Corrosion Inhibitors:

Another major function of antifreeze is to provide protection to the internal metal components of the Aqua-Hot Hydronic heating system from corrosion and rust. Antifreeze is able to perform this function by the addition of rust-and anti-corrosive inhibitors, which are designed specifically to activate in a water solution.

Summary:

Antifreeze has three basic functions: freeze protection, boil-over protection, and anti-corrosion and rust protection. Antifreeze is also primarily responsible for heat transfer characteristics. Therefore, as water is an excellent heat conductor, it is added to the mixture. A 50/50 solution of propylene glycol antifreeze and water is recommended to provide the best performance combination of the aforementioned functions. If excess propylene glycol exists within an antifreeze and water heating solution, the water’s heat absorption properties are compromised, which could ultimately inhibit the Aqua-Hot from providing adequate domestic hot water and interior heating.

Additionally, if the antifreeze and water heating solution contains over 70 percent antifreeze, the freezing point is actually raised, resulting in less freeze protection.

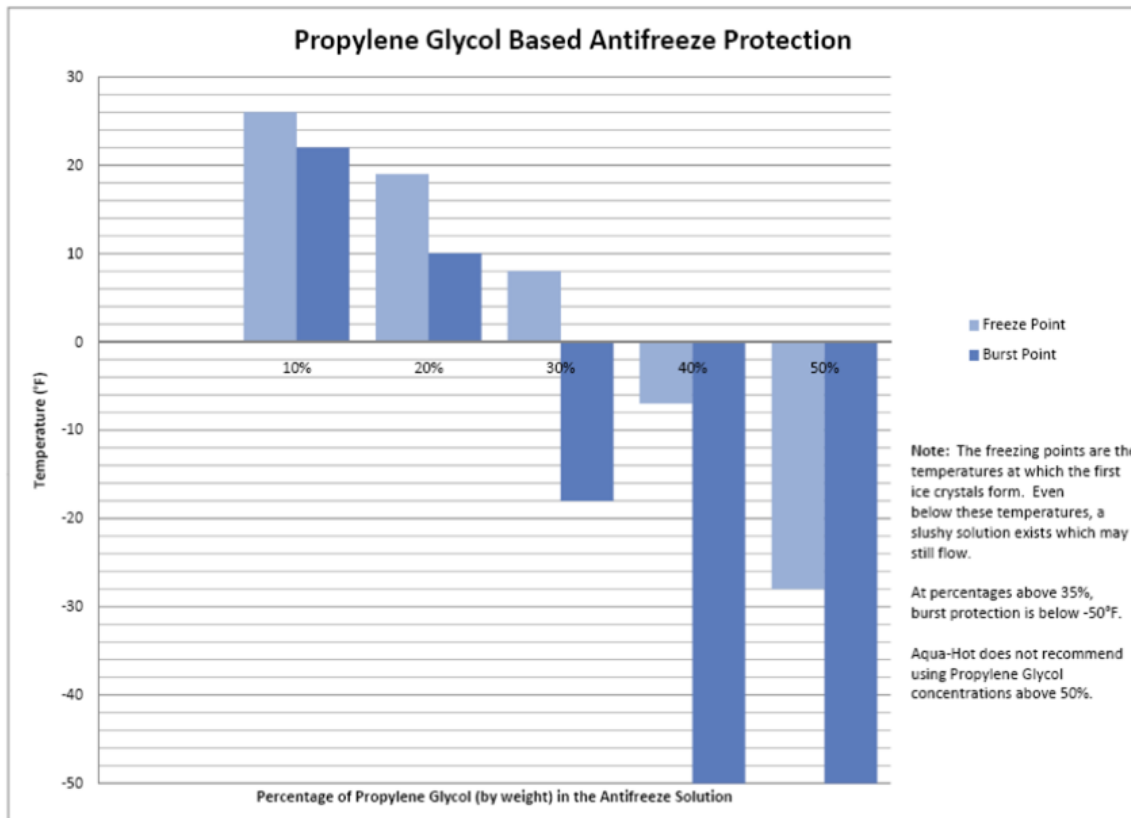

Measuring Antifreeze Using a Refractometer

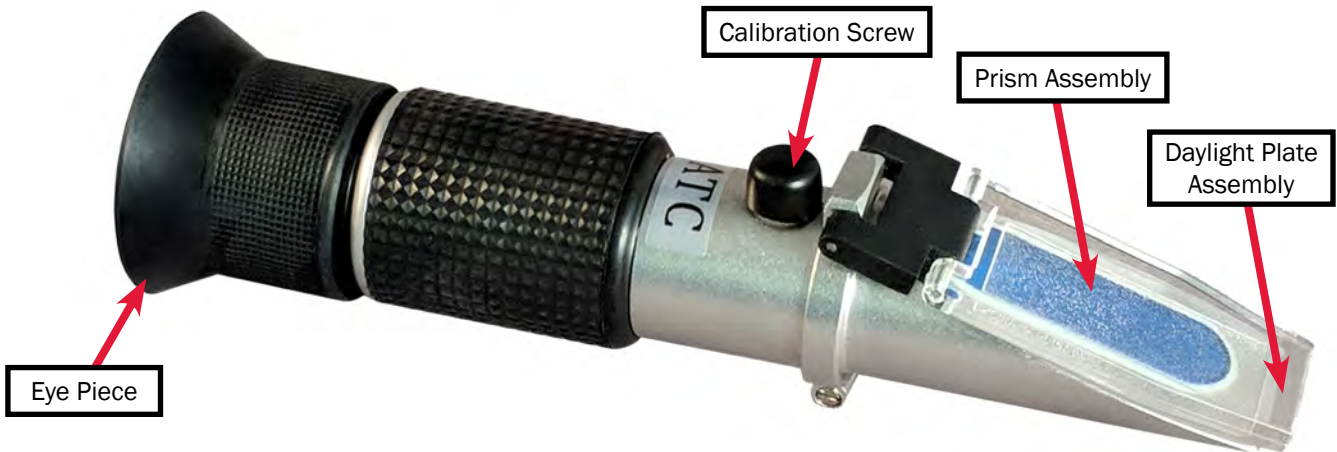

Properly Apply Antifreeze to the Prism Assembly

Use the guide below to properly apply the propylene glycol mixture to the prism assembly of the refractometer. Once that is complete, peer through the eyeglass of the refractometer to continue to the next step.

Adjust the Boundary Line

Once the glycol solution has been properly applied, adjust the calibration screw until the boundary line labeled "Propylene Glycol" is set to 32 °F. The graphic to the right has been designed as an aid, but note that it may differ from what is shown in the refractometer sight glass.

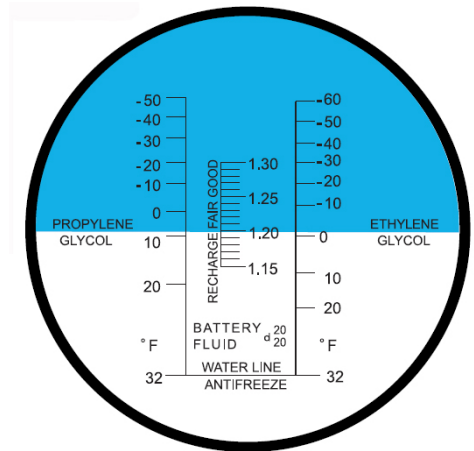

Refractometer Sight Glass

Application of Propylene Glycol

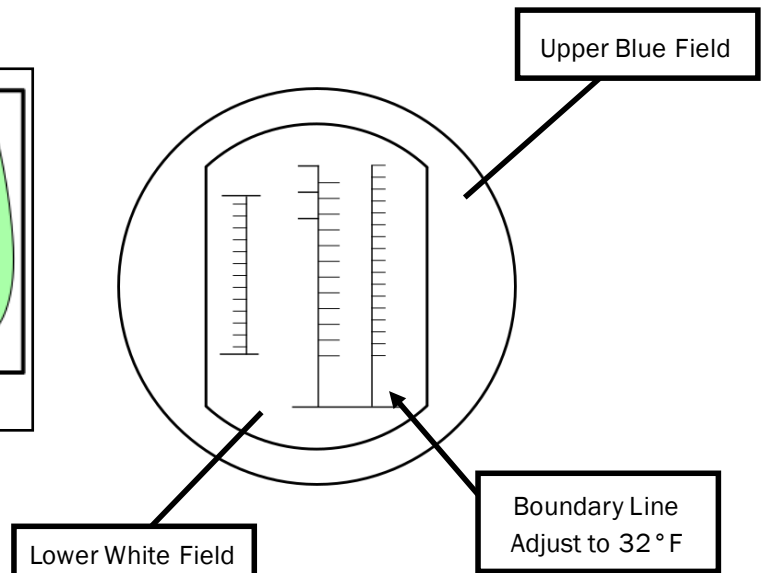
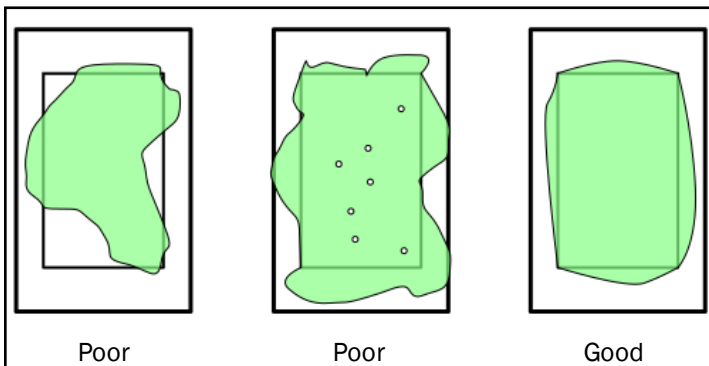

Interior Switch Panel

Introduction:

The interior switch panel is used to control the two potential heating sources for the Aqua-Hot's boiler tank, as well as to control the engine preheat feature. When a switch is activated, the indicator light on the switch will illuminate.

Coach Control Panel Screen:

Newer Aqua-Hot units that come equipped with the Reporter may have a coach touch-screen display instead of the interior switch panel. Please confirm with your coach dealer or vehicle manufacturer the location and functionality of your interior control screen.

Diesel-Burner Switch:

When the diesel-burner switch is in the ON position and the control thermostat or ETS Module tells the Reporter that heat is needed for the boiler tank, the diesel-burner will respond by firing up and providing heat. A cold boiler tank can expect to be brought to operating temperature by the diesel-burner in approximately 10 to 20 minutes. In order to obtain continuous hot water, the diesel-burner switch must be activated.

Additionally, the diesel-burner switch can be used to reset a low-voltage condition. This is accomplished by turning off the diesel-burner switch for 30 seconds, then turning it back on, or by resetting the Reporter.

Electric Element Switch:

When the motor home is plugged into an AC power source (e.g., shore power, generator, etc) and the electric element switch is on, the electric heating element will be used to provide heat to the boiler tank if the need arises. A cold boiler tank can expect to be brought to operating temperature by the electric heating element in approximately 1 to 2 hours. The electric element, alone, will not be able to provide continuous hot water.

Engine Preheat Switch:

The engine preheat switch activates the engine preheat pump, which draws the motor home's engine coolant through the boiler tank to heat it before returning it to the engine block to transfer the heat there. Either the diesel-burner switch or the electric element switch must also be activated in order for the engine preheat feature to function. The engine preheat switch does not need to be activated for the motor-aid feature to work and should be shut off when traveling.

NOTE: If the diesel burner fails to ignite, it will trigger a fault on the Aqua-Hot Reporter (DE5 and newer).



Figure 9

Switches Rear View

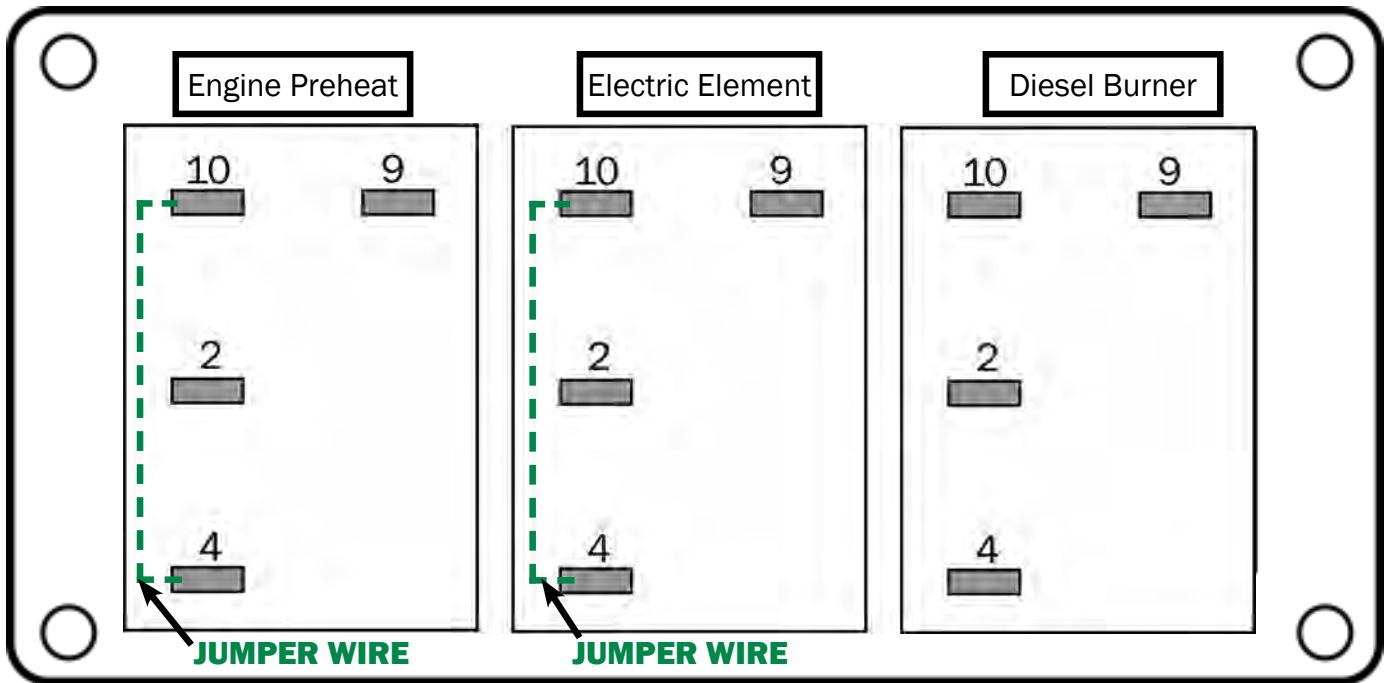

Switch Pin	Wire Harness
#2	J9-1
#4	J1-4
#9	Chassis Ground

Switch Pin	Wire Harness
#2	J9-2
#4	J1-2
#9	Chassis Ground

Switch Pin	Wire Harness
#2	J1-1
#4	J9-3
#10	J7-3
#9	Chassis Ground

NOTE: The Engine Preheat and Electric Element switches possess jumper wires that advance from terminal 4 to terminal 10.

Exhaust System Requirements

Introduction:

The following section will detail the specific Exhaust System Requirements of the Aqua-Hot 450D. Follow these requirements without deviation to ensure optimal unit operation.

Because the Aqua-Hot's exhaust is hot and must be kept away from any heat-sensitive material, the exhaust system should be checked to ensure that it continues to meet the following requirements:

Installation Guidelines:

- The exhaust must NOT be directed downwards, as a fire could result under certain conditions
- The exhaust must NOT terminate beneath the vehicle, beneath an open-able window
- The exhaust must NOT vent in the awning area of the motor home or near the slide-out areas
- The exhaust must be able to freely exit away from the vehicle without any obstructions
- 2-in standard automotive-type exhaust pipe should be used
- Total exhaust length must NOT exceed 20 feet, and shall contain no more than two 90° bends
- The 3-in and 4-in black pipe nipples and the exhaust elbow - originally supplied with the Aqua-Hot must be present

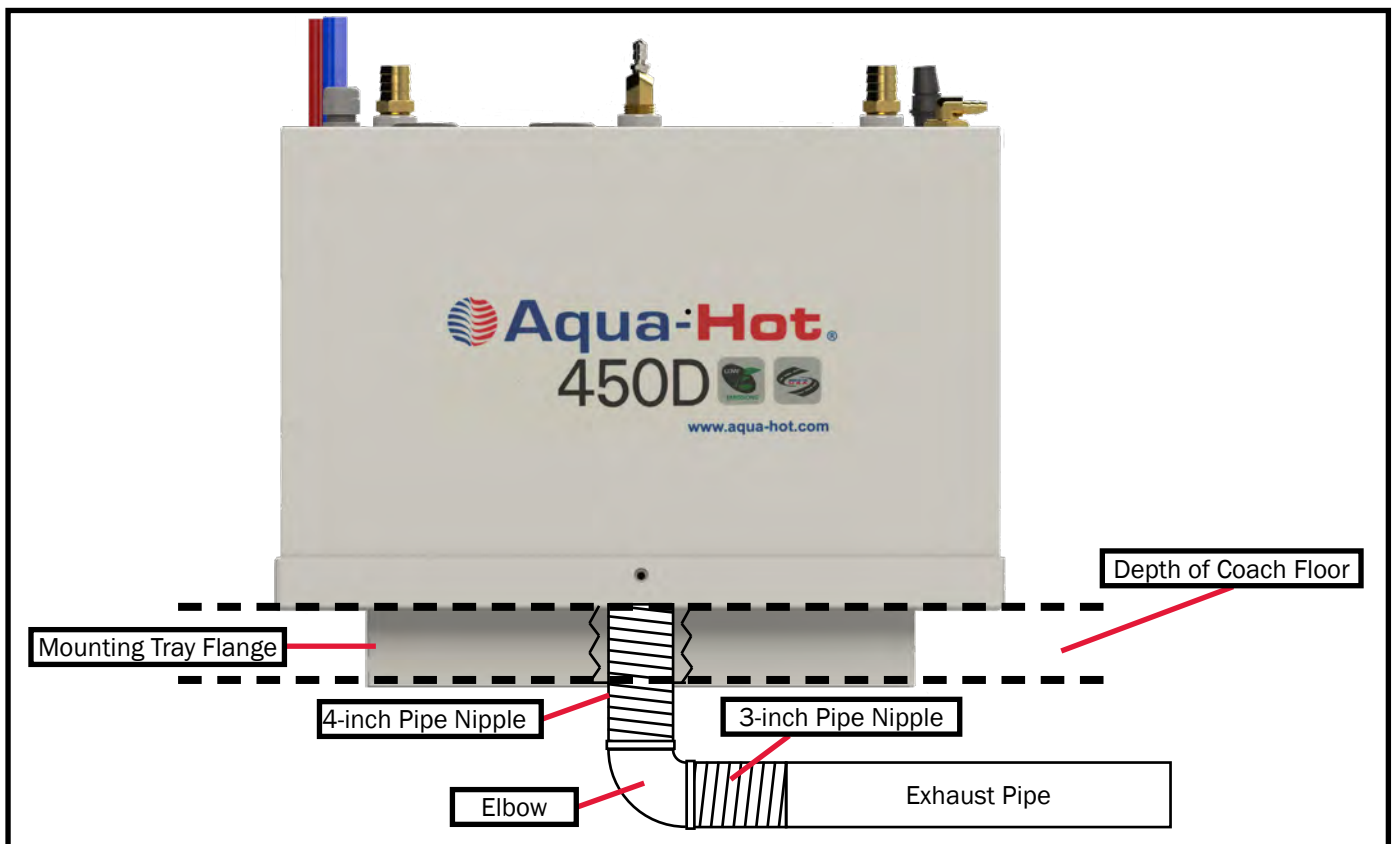

Figure 10

Interlock Switch

Introduction:

The interlock switch is a safety device designed to ensure that the Aqua-Hot's access cover is securely installed before allowing the diesel-burner to operate.

If the Aqua-Hot fails to operate, and shows no illuminated lights or displays, it is possible that the interlock switch is faulty. Follow the directions below to troubleshoot, and if necessary, replace the interlock switch.

Troubleshooting:

NOTE: The interlock switch will prevent the diesel-burner from operating without the access cover intact; therefore, the switch will need to be manually pressed during testing for the switch's functionality.

1. Turn the diesel-burner switch on from the interior switch panel and ensure that the boiler tank has sufficiently cooled in order to require heat from the diesel burner.
2. Verify that the "Diesel-Burner Status" is ON on the Reporter, and that the tank temperature is below 190 °F.

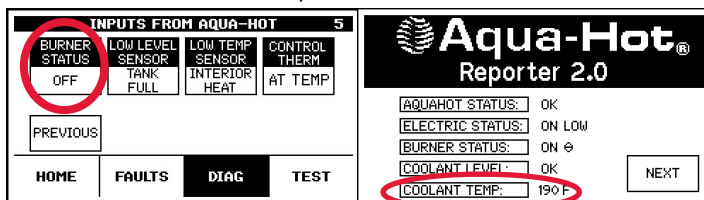

3. Disconnect the two yellow wires from the interlock switch noting that wire #24 is connected to the terminal labeled "NO" and wire #25 is connected to the terminal labeled "COM."
4. Using an ohmmeter, check the interlock switch for continuity while the button is pushed in.

If continuity is not present with the button pushed in, follow the instructions in this section to replace the interlock switch.

DANGER

FAILURE TO DISCONNECT ALL POWER SUPPLIES AND/OR TO ALLOW THE HEATER TO COOL BEFORE SERVICING COULD CAUSE SERIOUS DAMAGE OR PERSONAL INJURY.

Replacement Procedure:

1. Disconnect the Aqua-Hot from all power sources.
1. Disconnect the interlock switch's wires by pulling the quick connectors from the switch's spade terminals.
2. Release the interlock switch from the Aqua-Hot cabinet by pushing in on the locking tabs and pulling the interlock switch.
3. Remove the defective interlock switch from the Aqua-Hot.
4. Install the replacement interlock switch onto the Aqua-Hot ensuring that the locking tabs snap into place.
5. Connect the Aqua-Hot's wires to the replacement interlock switch with yellow wire #24 connected to the terminal labeled "NO" and yellow wire #25 connected to the terminal labeled "COM."

NOTE: If the interlock switch wires are reversed, the interlock switch will only allow the diesel-burner to operate when the access cover is removed and the button on the switch is released.

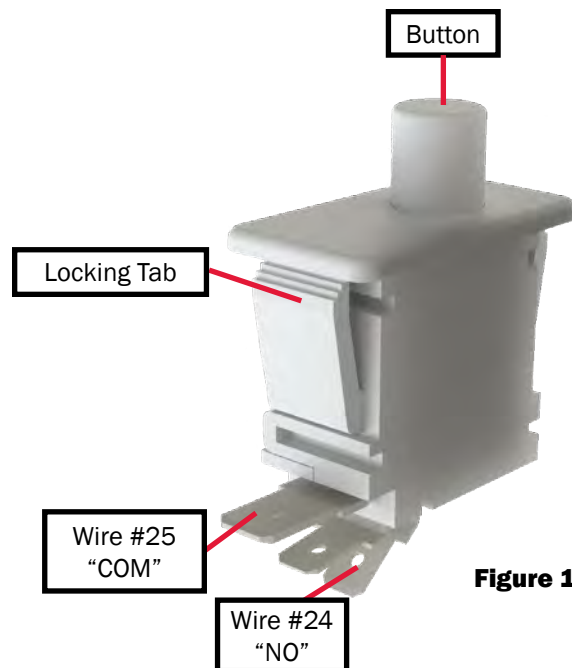

Figure 11

Fluid-Level Sensor

Introduction:

The fluid-level sensor monitors the level of antifreeze and water heating solution within the Aqua-Hot's boiler tank to ensure that an adequate volume exists.

Troubleshoot the fluid-level sensor if the Reporter has issued a low fluid level fault and the Aqua-Hot is adequately filled.

The fluid-level sensor operates by relaying a continuity signal to the Reporter while it is wet. If this signal does not exist, then there may be an issue with the Reporter, OR the fluid level sensor may be physically damaged. Follow the directions below to troubleshoot the fluid level sensor.



Figure 12

Troubleshooting Procedure:

1. Verify that the wires terminating at the fluid level sensor are not damaged, corroded, or otherwise faulty.
2. Verify that the wires terminating at the Reporter are not damaged, corroded, or otherwise faulty.
3. Clamp the zone hoses shut to prevent the zones from draining into the Aqua-Hot.

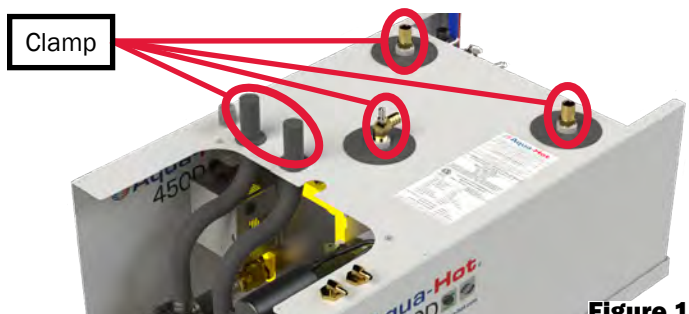

Figure 13

4. Drain approximately 2 gallons of fluid into an external container to be reused.
5. Using a $\frac{3}{16}$ " wrench, or deep socket, loosen and remove the fluid level sensor from the tank face.

6. If the sensor is corroded or the stainless steel rod is corroded, rusted, or otherwise damaged the fluid level sensor will need to be replaced.

Please note that if the sensor is covered in residue, it may be functioning improperly. If this occurs, clean the sensor off and retest the Aqua-Hot for functionality BEFORE replacing the fluid level sensor.

Replacement Procedure:

1. Clamp the zone hoses shut to prevent the zones from draining into the Aqua-Hot.

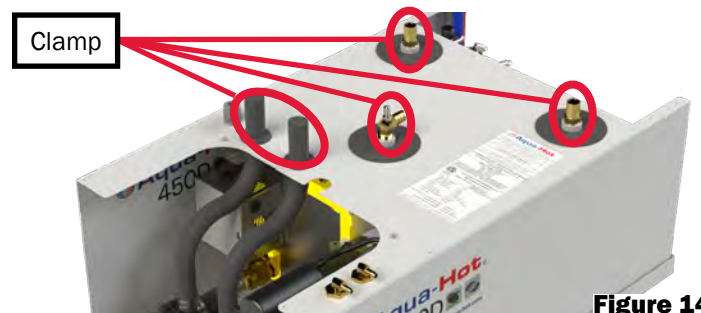

Figure 14

2. Drain approximately 2 gallons of fluid into an external container to be reused.
3. Remove the nut securing the wire in place on the fluid level sensor.
4. Using a $\frac{3}{16}$ " wrench, or deep socket, loosen and remove the fluid level sensor from the tank face.
5. Discard this sensor.
6. Place the new sensor in position on the tank face and finger tighten it into place.
7. Using a $\frac{3}{16}$ " wrench or deep socket, tighten the sensor until it is snug. DO NOT OVER TIGHTEN THIS SENSOR.
8. Reconnect the previously disconnected wire to the new fluid sensor.
9. Test the Aqua-Hot for normal operation.

Coolant Temperature Sensor (ETS)

Introduction:

The ETS module precisely measures the temperature of the coolant inside of the Aqua-Hot boiler tank. This allows for very granular control of the unit to deliver precise heating and hot water as needed.

The ETS module went live on the Aqua-Hot 450-DE5 series. Older units utilized the control thermostat.

The ETS module should be diagnosed if the Reporter is displaying an incorrect temperature when accompanied by issues such as lack of interior heat or hot water.

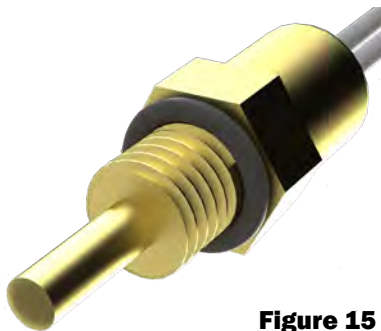

Figure 15

Troubleshooting Procedure:

1. Locate the thermostat within the Aqua-Hot and its associated wires.
2. Verify that these wires are not corroded, cut, or otherwise damaged.
3. Check the J8-6 and J8-3 pins on the Reporter to check for cut, corroded, or otherwise damaged wiring.
4. Using a meat thermometer, measure the temperature of the tank face of the Aqua-Hot.
5. Record this temperature on a notepad.
6. Locate the Reporter, and access the home page.
7. Find the element entitled "COOLANT TEMP".

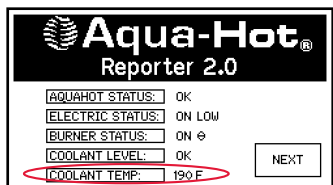

Figure 16

8. If the temperature displayed is not approximately the same as the temperature recorded earlier, the ETS module will need to be replaced.

Replacement Procedure:

1. Clamp shut the zone hoses to prevent the zone from draining.
2. Open the unit drain valve located on the bottom left of the heater, and allow approximately 2 gallons to drain from the unit.
3. Disconnect the wires of the existing ETS module.
4. Using a 10mm socket deep-well socket, remove the defunct ETS module and discard it.
5. Place the new ETS module onto the tank face, and finger tighten it.
6. Using a 10mm deep-well socket, tighten the ETS module until it is snug. **DO NOT OVER-TIGHTEN THE ETS MODULE.**
7. Reconnect the wires of the ETS module.
8. Test the Aqua-Hot for normal operation.

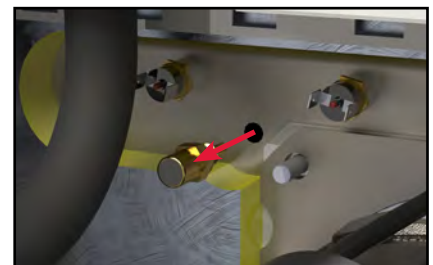

Figure 17

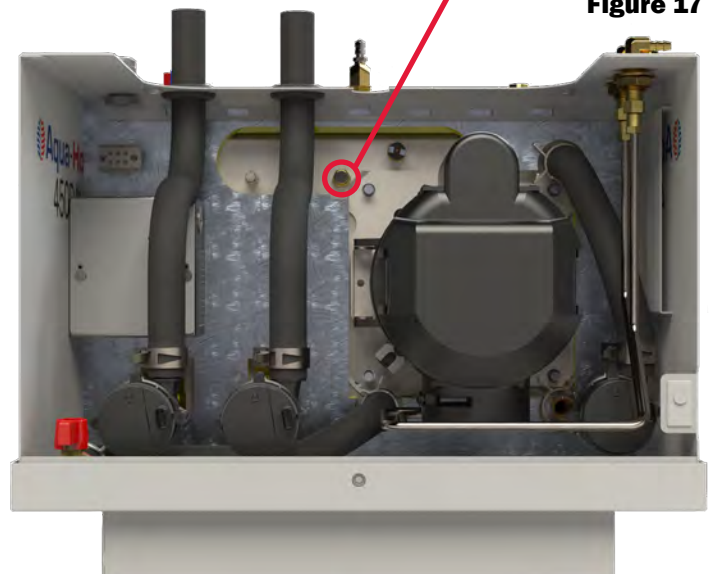

Figure 18

AC High-Limit Thermostat

Introduction:

The AC High-Limit thermostat serves as a safety measure in the event that the electric heating element continues to operate after the maximum operating temperature is reached. The high-limit thermostat allows the current for the heating element to pass through it until the boiler tank reaches a temperature of 215°F. Should this temperature be reached, the high-limit thermostat blocks the current to the element, which prevents it from continuing to provide heat to the boiler tank.



Figure 19

Begin troubleshooting the AC High-Limit Thermostat if the Reporter issues an overheat fault, or the electric heating element fails to operate correctly.

Troubleshooting Guidelines:

The following conditions must be met before the AC High-Limit Thermostat can be diagnosed, and if necessary, repaired.

- The fluid expansion bottle is filled to at least the “COLD” mark.
- Verify that all in-line fuses are functional.
- Ensure that the unit is completely cool.
- Ensure that DC electrical power is supplied to the Aqua-Hot.
- Ensure that AC electrical power is supplied to the Aqua-Hot’s electric element.

If any of the above conditions are not met, correct them before continuing with troubleshooting. Results of the troubleshooting procedure cannot be verified if the conditions listed above are not fulfilled.

Troubleshooting Procedure:

1. Disconnect all power supplies.

NOTE: If the High-Limit Thermostat is tripped, it is recommended to test the control thermostat/ETS Module for proper operation.

2. Remove the AC access cover.
3. Verify that the boiler’s tank temperature is below 215°F.
4. Locate the AC high-limit thermostat and remove its wires.
5. Using an ohmmeter, check the thermostat for continuity.
 - If there is no continuity, press the white reset button on the thermostat and recheck for continuity.
 - If continuity is still not present after the reset button has been pressed, follow the instructions in this section to replace the AC high-limit thermostat.

Replacement Procedure:

1. Ensure that the Aqua-Hot has been completely shut down, and that all power supplies have been disconnected.
2. Remove the AC access cover.
3. If applicable, remove the heat shrink insulation covering the wires and terminals on the defective high-limit thermostat.
4. Disconnect the high-limit thermostat from the electric element and AC relay by removing the screws with a Philips screw driver.
5. Using a $\frac{5}{8}$ ” wrench or socket, remove the defective high-limit thermostat from the Aqua-Hot’s boiler tank.
6. Install the replacement high-limit thermostat into the port on the Aqua-Hot’s boiler tank and finger tighten only (15 in-lbs).
7. Connect the wires on the replacement high-limit thermostat in the same configuration as they were removed.

NOTE: One wire will attach to the electric heating element and one wire will attach to the AC relay.

8. Secure the AC access cover back into place.
9. Test for proper operation.

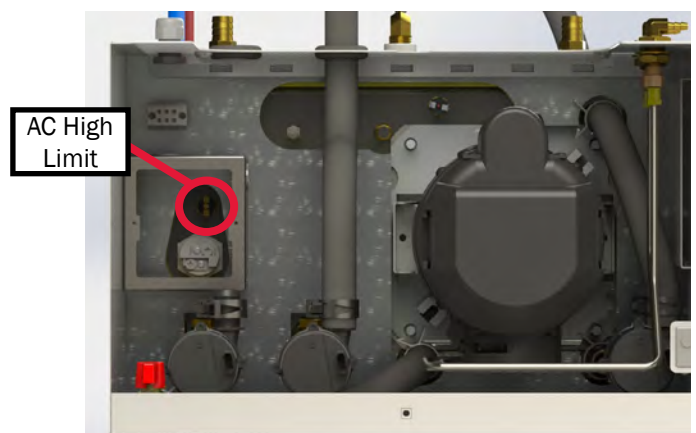

Figure 20

DC High-Limit Thermostats

Introduction:

The DC high-limit thermostats serve as a safety measure in the event that the diesel-burner continues to operate after the maximum operating temperature is reached. The high-limit thermostats allow the current for the diesel-burner to pass through them until the boiler tank reaches a temperature of 215°F. Should this temperature be reached, the high-limit thermostat blocks the current to the diesel-burner's fuel solenoid valve, which prevents the diesel-burner from operating.

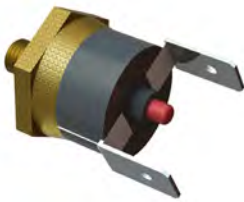

Figure 21

Begin troubleshooting the DC High-Limit Thermostats if the Reporter issues an overheat fault, or the diesel-burner or fuel solenoid fails to operate correctly.

Troubleshooting Guidelines:

The following conditions must be met before the High-Limit Thermostats can be diagnosed, and if necessary, repaired.

- The fluid expansion bottle is filled to at least the "COLD" mark.
- Verify that all in-line fuses are functional.
- Ensure that the unit is completely cool.
- Ensure that DC electrical power is supplied to the Aqua-Hot.

If any of the above conditions are not met, correct them before continuing with troubleshooting. Results of the troubleshooting procedure cannot be verified if the conditions listed above are not fulfilled.

Troubleshooting Procedure:

1. Place a jumper wire between the blue and purple wires on the diesel-burner's wire harness to bypass the high-limit thermostats. Check the Aqua-Hot for normal operation.

NOTE: Bypassing the high-limit thermostats is for testing only and must not be used for the Aqua-Hot's normal functioning.

2. Disconnect the DC high-limit thermostats' wires, then with an ohmmeter, check each thermostat for continuity.

If there is no continuity, complete the following:

- Press the reset button on the high-limit thermostat, then recheck for continuity.
- Disconnect the wires from each thermostat and recheck each thermostat for continuity, as well as each of the thermostats' individual wires.
- If an individual wire does not have continuity, that wire must be replaced.
- If a thermostat with the wires removed that has been reset does not have continuity, follow the instructions in this section to replace the high-limit thermostat.

NOTE: If the high-limit thermostats continue to trip, troubleshoot the control thermostat/ETS Module, and verify the boiler tank is full of the heating solution.



DANGER

Failure to disconnect all power supplies and/or to allow the heater to cool before servicing could cause serious damage or personal injury.

Replacement Procedure:

1. Ensure that the Aqua-Hot has been completely shut down, and that all power supplies have been disconnected.
2. Remove the two wires from the defective high-limit thermostat by pulling firmly on the wires.
3. Using a 5/8" wrench or socket, remove the defective high-limit thermostat from the Aqua-Hot's boiler tank.
4. Install the replacement high-limit thermostat into the port on the Aqua-Hot's boiler tank and finger tighten only (15 in-lbs).
5. Connect the wires removed from the defective high-limit thermostat to the replacement high-limit thermostat.

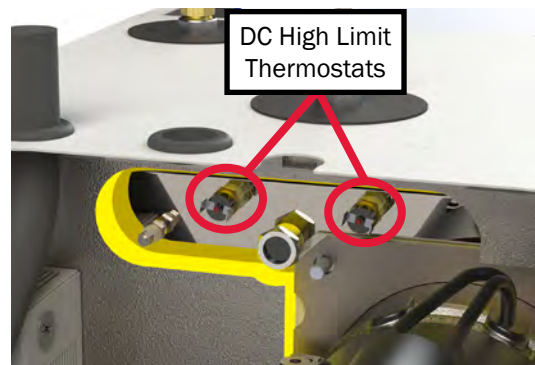

Figure 22

Low-Temperature Cutoff Thermostat

Introduction:

The low-temperature cutoff thermostat (LTCO) operates the domestic hot water priority system by blocking the interior heating feature when domestic hot water is being used. This ensures that even heat is provided for domestic hot water, which avoids the possibility of cold water pockets during showers, etc.



Figure 23

Begin troubleshooting the Low-Temperature Cutoff Thermostat if the following conditions have occurred:

- There is a lack of interior heat
- There is a lack of hot water

Troubleshooting Procedure:

1. Locate the Reporter and navigate to “INPUTS FROM AQUA-HOT”

INPUTS FROM AQUA-HOT			
BURNER STATUS	LOW LEVEL SENSOR	LOW TEMP SENSOR	COOLANT TEMP
OFF	TANK FULL	INTERIOR HEAT	190 F
PREVIOUS			
HOME	FAULTS	DIAG	TEST

Figure 24

2. Turn on a hot water faucet within the coach. Monitor the Reporter screen.
3. Confirm the Low Temp Sensor element displays “HOT WATER”. If it displays “INTERIOR HEAT”, locate the LTCO in the Aqua-Hot cabinet.
4. Using a multimeter, test the LTCO for continuity.
5. If the LTCO does not have continuity while hot water is running, follow the procedure to replace the LTCO.



Replacing the Low-Temperature Cutoff Thermostat:

1. Disconnect the wires from the LTCO by separating the quick-disconnect terminals.
2. Remove and discard the defunct LTCO thermostat using a 5/8” wrench.
3. Position and secure the new LTCO thermostat into place. Hand tighten only to **15 in-lbs**. Do NOT over-tighten.
4. Connect the replacement low-temperature cutoff thermostat’s wires in the same configuration as the removed thermostat’s wires.

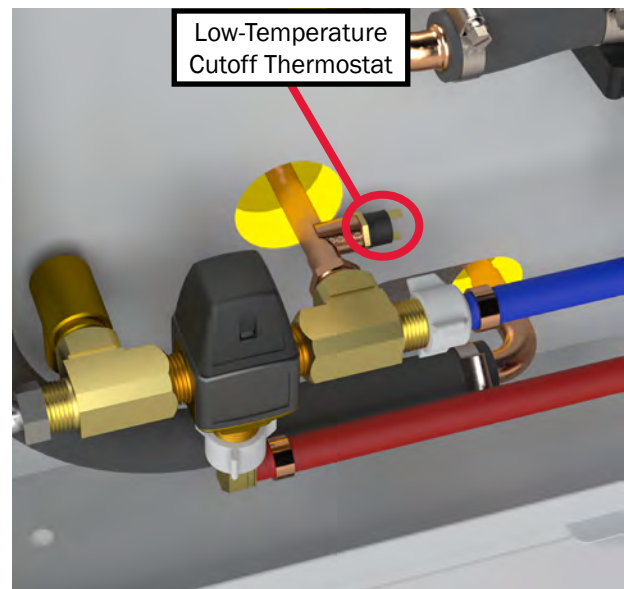

Figure 25

Check Valves

Introduction:

Check valves are installed into the zone outlet ports for each heating loop to ensure that the antifreeze and water heating solution only flows in one direction. If the heating solution attempts to back flow into the boiler tank, the check valve closes to prevent that from happening.



Figure 26

Troubleshoot the check valves if there is a lack of interior heat in a particular zone.

Troubleshooting Procedure:

1. Verify that the heating zone is operating properly by checking the following:
 - Check the Reporter “DIAG” screen on OPERATING MODE to ensure that the heating zone is on.

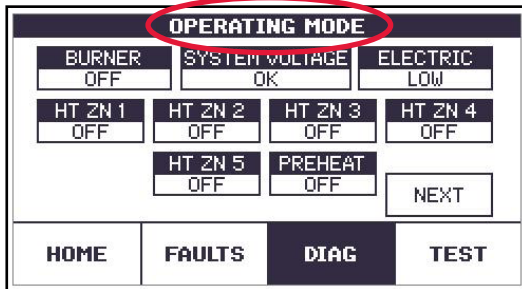

Figure 27

- Check the “OUTPUTS TO AQUA-HOT” to ensure the corresponding pump is on.

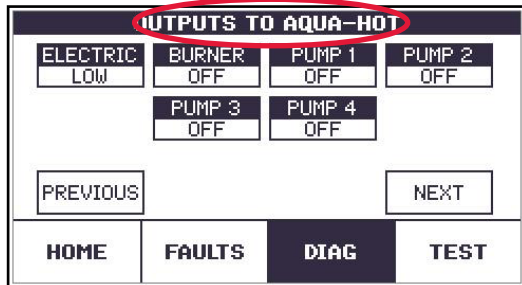

Figure 28

2. With the circulation pump operating, tap on the check valve and wait five minutes to evaluate if interior heat is now present.
 - If interior heat is present after tapping the check valve, the check valve was stuck closed and no further action is needed.
3. Check the Aqua-Hot’s antifreeze and water heating solution’s ratio of water to propylene glycol. The mixture ratio should be approximately 50/50. If the solution is comprised fully of antifreeze (100%), the check valves will continue to stick.

NOTE: Storing the motor home for an extended period of time can cause the check valves to stick. If after the initial release of the stuck check valve, it continues to stick, follow the instructions in this section to replace the check valve.

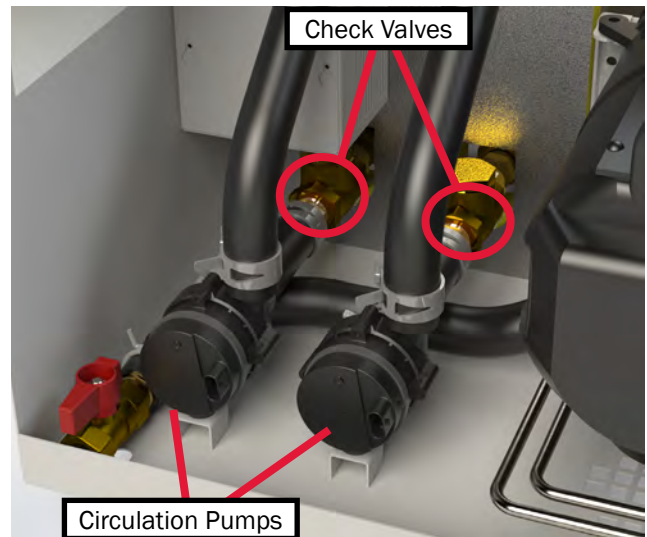

Figure 29

Replacing the Check Valve:

1. Ensure that the Aqua-Hot has been completely shut down and that all power sources have been disconnected. Be sure the boiler tank has adequately cooled.
2. Drain the antifreeze and water heating solution from the boiler tank using the drain valve.
3. Using constant tension pliers, loosen and slide back the constant tension clamp securing the hose to the defective check valve.
4. Remove the hose from the defective check valve.
5. Unscrew the defective check valve from the Aqua-Hot’s boiler tank.

- Remove the hose barb and the ½” coupler from the defective check valve.

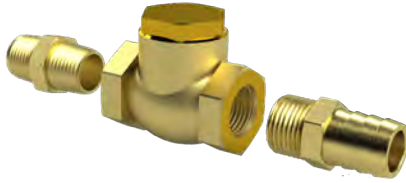

Figure 30

- Clean the hose barb and coupler, then wrap the hose barb and ½” coupler pipe threads with Teflon tape.
- Install the hose barb and ½” coupler on the replacement check valve, ensure that they are installed properly with the hose barb on the arrow side of the check valve.
- Install the replacement check valve onto the boiler tank. The arrow on the check valve must point away from the tank.
- Slide the hose back onto the replacement pump and set the constant tension clamp back into place.
- Refill the Aqua-Hot’s boiler tank with the antifreeze and water heating solution.

Tempering Valve



Figure 31

Introduction:

The tempering valve for the Aqua-Hot mixes the heated domestic water from the boiler tank with cold domestic water from the coach’s fresh water tank to reduce the risk of scalding.

Testing Procedure:

Follow the testing procedure to the right in order to diagnose the tempering valve. Troubleshoot the tempering valve if the following conditions have occurred:

- A lack of hot water.
- Hot water supply is uneven.
- Hot water is too hot.

NOTE: Adjusting the mixing valve beyond 120°F (49°C) will result in a lack of hot water and may result in scalding. Do NOT attempt to adjust the tempering valve without assistance from Aqua-Hot Technical Support or a qualified Aqua-Hot technician.

- Inspect the tempering valve to ensure that is not leaking.
- Test the temperature of the hot water using a digital thermometer at one of the hot water faucets. Water temperature should range between 115°F - 123°F. If the proper range cannot be set follow the instructions in this section to replace the tempering valve.
- Test the tempering valve’s functionality by turning the knob. If the tempering valve knob does not turn freely, follow the instructions in this section to replace the tempering valve.

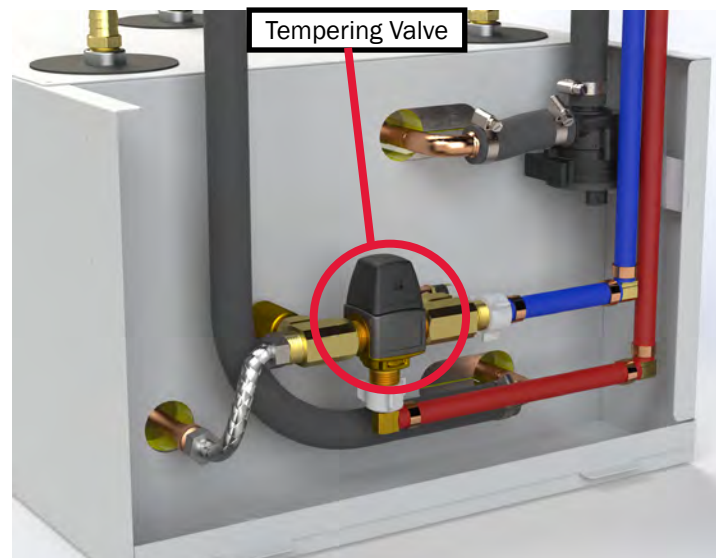

Figure 32

Replacement Procedure

- Turn the motor home’s water pump off.
- Drain the water pressure by opening the faucets and allowing the water drain.
- Disconnect the motor home’s water lines from the tempering valve assembly.
- Disconnect the PEX pipe and fittings from the tempering valve assembly.
- Remove the pressure relief valve assembly from the tempering valve assembly as the tempering valve cannot

be removed from the Aqua-Hot with the pressure relief valve still attached.

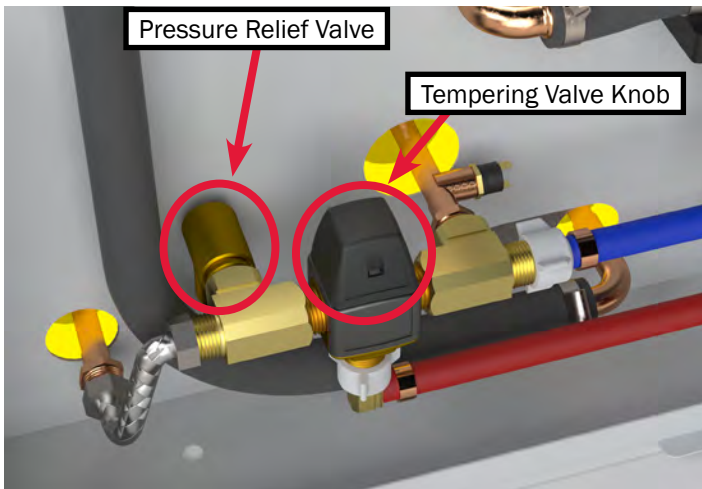

Figure 33

- Using a back-up wrench, unscrew the tempering valve from the Aqua-Hot.
- Remove the brass fittings from the defective tempering valve.

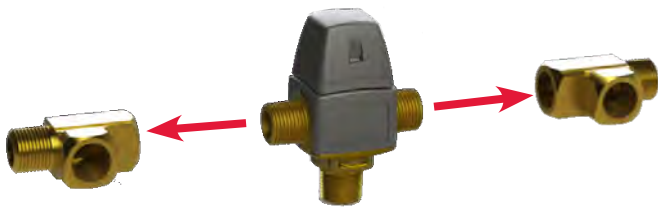

Figure 34

- Clean the brass fittings if necessary, then wrap the threaded fittings with Teflon tape.
- Install the brass fittings onto the replacement tempering valve.
- Install the replacement tempering valve onto the Aqua-Hot using a back-up wrench to tighten.
- Install the pressure relief valve onto the replacement tempering valve.
- Reconnect the PEX tube and fittings to the tempering valve and the Aqua-Hot. Be sure to inspect the rubber seals and replace if necessary.
- Reconnect the motor home's water lines to the tempering valve assembly.
- Turn the motor home's water pump back on and check for leaks and for any presence of hot domestic water.
- Verify that the replacement tempering valve has been set to the proper setting by taking a digital thermometer to a hot water faucet and set the water temperature between 115°F - 123°F.

Circulation Pumps

Introduction:

The circulation pumps first draw the heated antifreeze and water heating solution from the Aqua-Hot's boiler tank, then propel it through the Hydronic heating system's interior heat plumbing.



Figure 35

Troubleshoot the circulation pumps if the pump is not operating with the status ON on the Reporter, or the Reporter is showing an OVER-CURRENT fault for that pump.

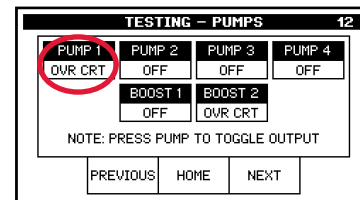

Figure 36

Troubleshooting Procedure:

- Verify the Low Temp Cutoff (LTCO) is showing on the Reporter, as it will be whenever the boiler tank is at operating temperature and domestic hot water is not being used.

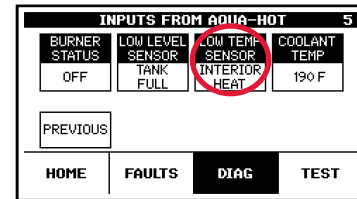

Figure 37

- Turn on the interior room thermostat corresponding to the circulation pump not operating (heating zones 1 & 5 operate with pump #1, and heating zones 2, 3, & 4 operate with circulation pump #2). Check the Zone status on the Reporter as shown below.

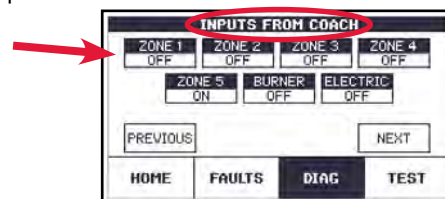

Figure 38

- Test the pump directly to determine that the Reporter is sending a signal to the pump to operate. Follow the steps to test that the pump is receiving power from the Reporter.

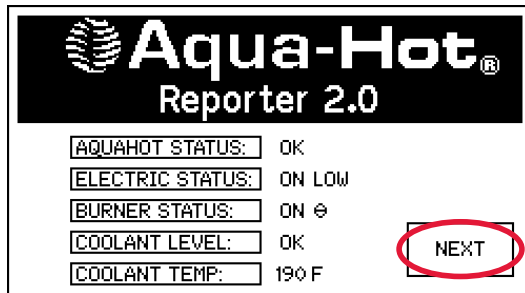

Figure 39

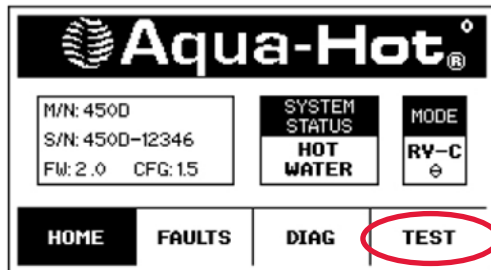

Figure 40

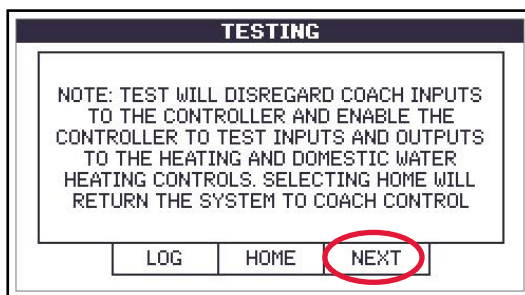

Figure 41

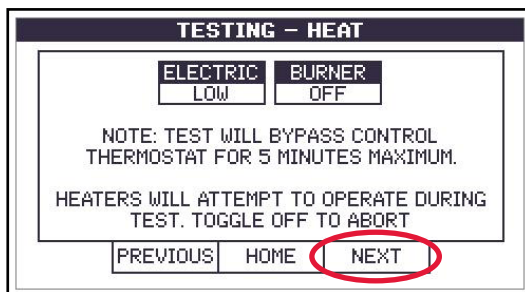
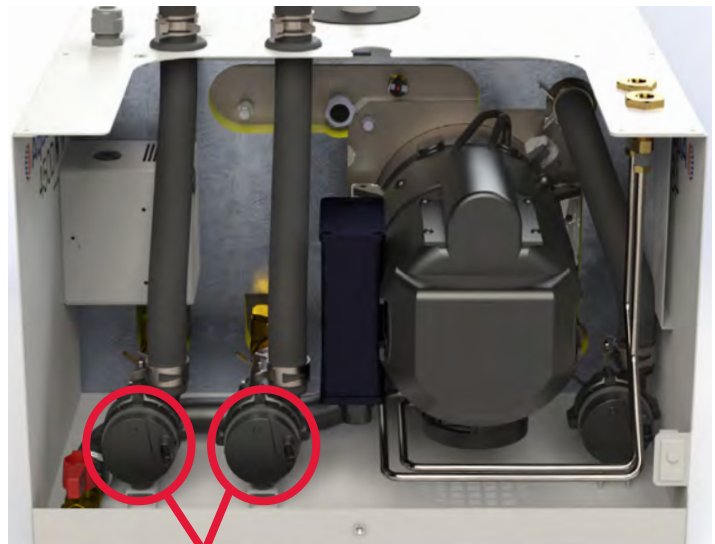

Figure 42



Zone Circulation Pumps

Figure 43

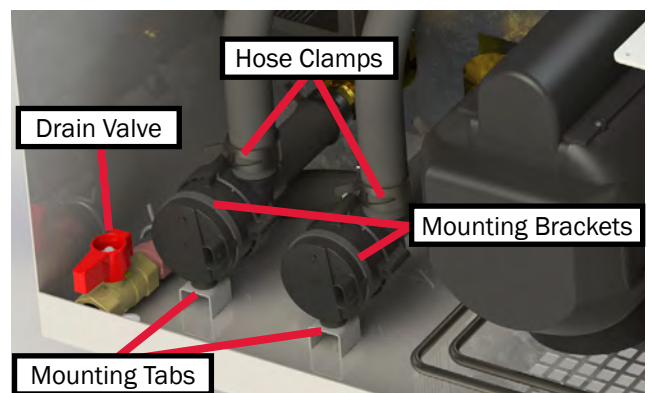

Figure 44

4. If the pump does not operate after testing, use a voltmeter to check for 12V DC power at the Reporter, on J2 (pin # will depend on which pump is faulty - refer to the schematic on page 98).
 - If the pump testing is ON and there is not 12V DC power at the J2 pin, the Reporter will need to be replaced.
 - If the Reporter is sending 12V DC power to the pump, and the pump is not operating, follow the replacement procedure to replace the defective pump.

Replacement Procedure

1. Ensure that the Aqua-Hot has been completely shut down and that all power sources have been disconnected. Be sure the boiler tank has adequately cooled down.
2. Drain the antifreeze and water heating solution from the boiler tank using the drain valve.
3. Disconnect the defective pump's wires by pulling out on the "Red Locking" tab on the harness plug, and separate the harness plug from the defective pump.

- Using constant tension pliers, loosen and slide back the constant tension clamps securing the hoses to the pump.
- Remove the hoses from the defective pump.
- Release the pump from the mounting bracket by inserting an AWL between the locking teeth and gently prying the locking teeth apart. Remove the defective pump.
- Slide the hoses onto the replacement pump and set the constant tension clamps back into place.
- Install the replacement pump onto the mounting bracket, and squeeze the pump bracket together with a pair of channel lock pliers to secure the pump.



Figure 45

- Reconnect the harness plug into the replacement pump. Be sure to push in on the red locking tab to secure the plug into place.
- Refill the boiler tank with the antifreeze and water heating solution previously drained.

Stir Pump /Circulation Pump #3

Introduction:

The stir pump circulates the antifreeze and water heating solution within the Aqua-Hot's boiler tank in order to ensure even heating of the solution. To accomplish this, the stir pump draws the solution from the bottom of the tank and immediately deposits it back into the top of the tank.

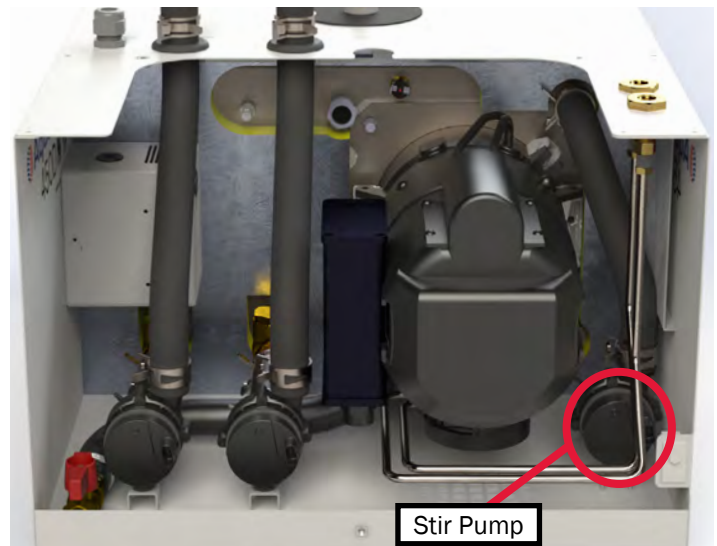

Figure 46

Troubleshoot the stir pump if there is a lack of hot water or the Reporter is showing an OVER-CURRENT fault for the pump.

NOTE: In order for the stir pump to operate, the diesel burner switch must be on and the "LOW TEMP SENSOR" must be OFF on the Reporter.

Troubleshooting Procedure:

- Verify the Low Temp Cutoff (LTCO) is showing on the Reporter, as it will be whenever the boiler tank is at operating temperature and domestic hot water is not being used.
- Power cycle the Aqua-Hot to clear any current faults.
- Navigate to the TESTING page on the Reporter and activate the stir pump. If the pump does not activate, test for voltage on the Reporter on pins J2-7 & J2-8.
 - If no voltage is present, the Reporter will have to be replaced.
 - If there is voltage, follow the steps to replace the stir pump.

Engine Preheat Pump

Introduction:

The Engine Preheat circulation pump draws the cold antifreeze and water heating solution from the motor home's engine and then transports it through the Engine Preheat heat exchanger that is located inside the boiler tank.

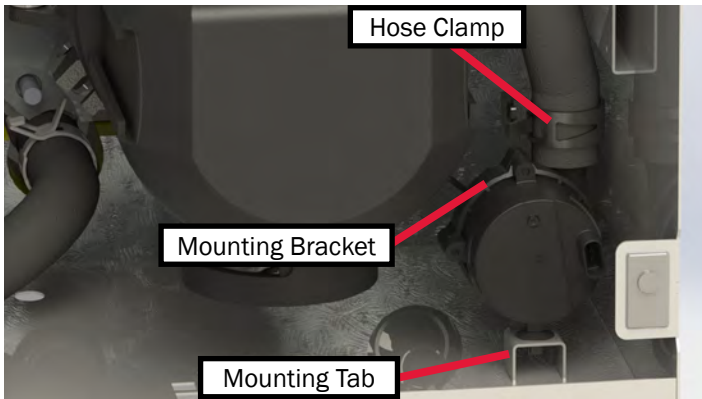

Figure 47

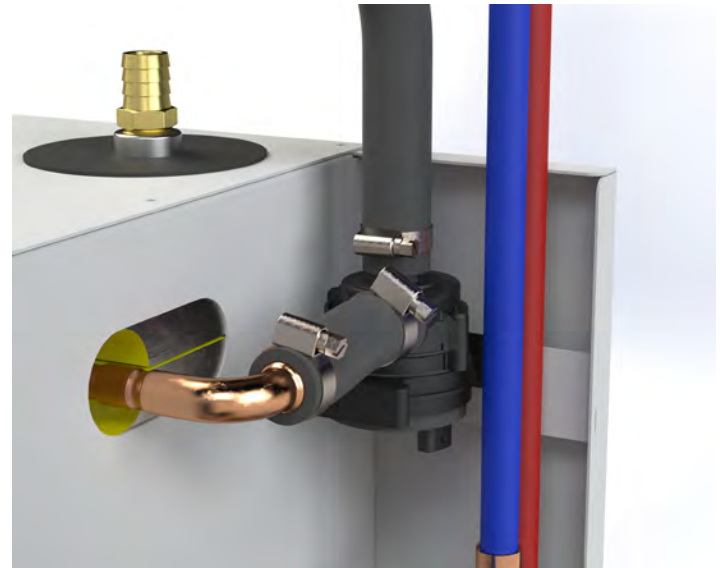

Figure 48

Troubleshoot the Engine Preheat pump if the pump is not operating, the Engine Preheat switch is on, Pump 4 is showing ON on the Reporter, and the "Low Temp Cutoff" indicator is showing on the Reporter.

Replacement Procedure

1. Ensure that the Aqua-Hot has been completely shut down and that all power sources have been disconnected. Be sure the boiler tank has adequately cooled down.
2. Drain the antifreeze and water heating solution from the boiler tank using the drain valve.
3. Disconnect the defective stir pump's wires by pulling out on the "Red Locking" tab on the harness plug, and separate the harness plug from the defective pump.
4. Using constant tension pliers, loosen and slide back the constant tension clamps securing the hoses to the pump.
5. Remove the hoses from the defective stir pump.
6. Release the pump from the mounting bracket by inserting an AWL between the locking teeth and gently prying the locking teeth apart. Remove the defective pump.
7. Slide the hoses onto the replacement pump and set the constant tension clamps back into place.
8. Install the replacement pump onto the mounting bracket, and squeeze the pump bracket together with a pair of channel lock pliers to secure the pump.
9. Reconnect the harness plug into the replacement pump. Be sure to push in on the red locking tab to secure the plug into place.
10. Refill the boiler tank with the antifreeze and water heating solution previously drained.

Troubleshooting Procedure:

NOTE: The diesel burner and/or electric element switch must be ON in order for the Engine Preheat feature to function.

1. Verify the Low Temp Cutoff (LTCO) is showing on the Reporter, as it will be whenever the boiler tank is at operating temperature and domestic hot water is not being used.
2. Verify that the Engine Preheat switch is in the ON position on the interior switch panel. Either the burner or electric switch need to be on as well.
3. On the Reporter, verify that PUMP 4 is on, along with the Low Temp Sensor, and the Electric or Burner.

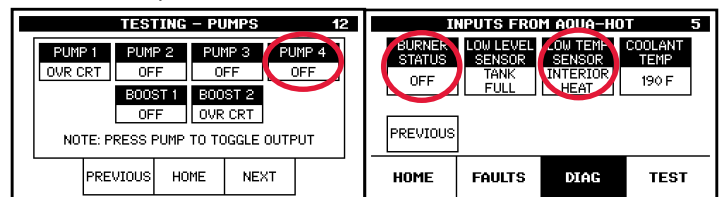

Figure 49

- If not, make sure the boiler tank is up to temperature and the burner/electric is turned on. If they are, there

may be an issue with the Reporter.

4. Navigate to the TESTING page on the Reporter and activate PUMP 4. If the pump is not operating after activating it on the Reporter, check for 12V DC power at the J2 Pins, J2-10 & J2-11. If voltage is present, follow the replacement procedure to replace the Engine Preheat pump. If no voltage is present, the Reporter will need to be replaced.

Replacement Procedure

1. Ensure that the Aqua-Hot has been completely shut down and all power sources have been disconnected. Make sure the heater is adequately cooled.
2. Using hose pinch off pliers, clamp both hoses attached to the engine preheat pump closed.
3. Disconnect the defective pump's wires by pulling on the "Red Locking" tab on the harness plug, separating the harness plug from the defective pump.
4. Using constant tension pliers, loosen and slide back the constant tension clamps securing the hoses to the engine preheat pump.
5. Remove the hoses from the defective pump.
6. Release the pump from the mounting bracket by inserting an Awl between the locking teeth and gently pry the locking teeth apart. Remove the defective pump from the Aqua-Hot.
7. Slide the hoses onto the replacement pump and set the constant tension clamps back into place.
8. Install the replacement pump onto the mounting bracket and squeeze the pump bracket together with a pair of channel lock pliers to secure the pump.
9. Reconnect the harness plug into the replacement pump. Be sure to push in on the red locking tab to secure the plug into place.
10. Remove the hose pinch off pliers previously installed on both hoses.
11. Test the Aqua-Hot for normal operation.

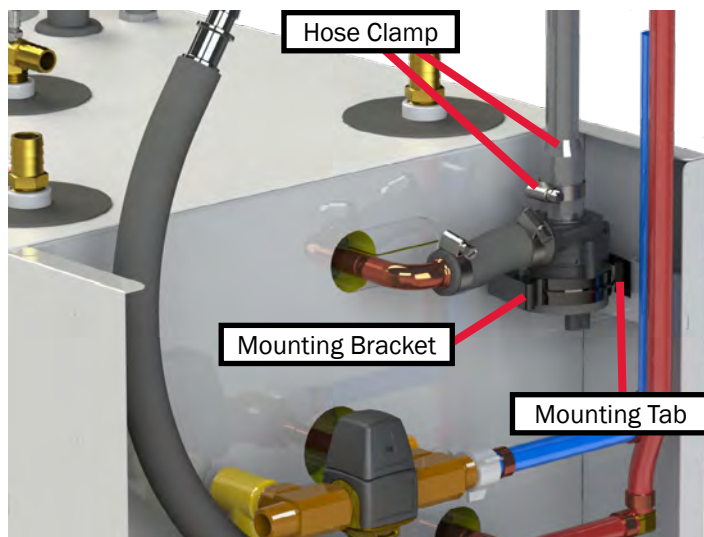

Figure 50



Figure 51

AC Electric Element

Introduction:

The electric heating element uses AC power as an alternate power source for heating the Aqua-Hot's boiler tank.

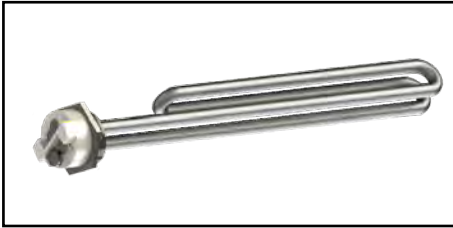

Figure 52

Begin troubleshooting the electric element if there is a lack of hot domestic water and/or interior heat when the electric element is selected as the heating source.

NOTE: For continuous domestic hot water, the diesel burner must be selected as a heating source as well. The element is not able to provide continuous hot water.

Troubleshooting Guidelines:

The following conditions must be met before the electric heating element can be diagnosed, and if necessary, replaced.

- The fluid expansion bottle is filled to at least the "COLD" mark.
- Verify that all in-line fuses are functional.
- The AC high-limit thermostat is operating and not tripped.
- Ensure that the unit is completely cool.
- Ensure that DC electrical power is supplied to the Aqua-Hot.
- Ensure that AC electrical power is supplied to the Aqua-Hot's electric element.

If any of the above conditions are not met, correct them before continuing with troubleshooting. Results of the troubleshooting procedure cannot be verified if the conditions listed above are not fulfilled.

Troubleshooting Procedure:

1. Verify that the motor home is either plugged into shore power or that the generator is running to provide AC power and the electric switch is ON on the interior switch panel.

2. Verify that the Electric shows ON on the Reporter.

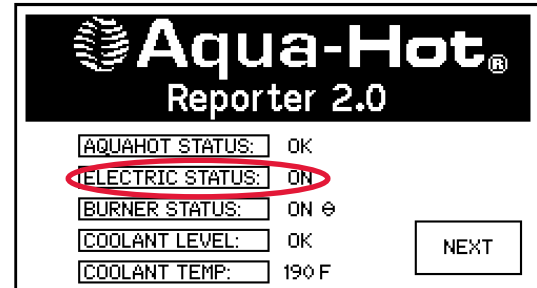

Figure 53

- If the interior switch is on, the Reporter is not showing the electric as ON, and the tank is below 215°F, the Reporter will need to be replaced.

3. Verify that the boiler's tank temperature is below 215°F.

- If the boiler tank temperature is below 158°F, test the control thermostat/ETS Module.
- If the boiler tank is above 158°F, the Aqua-Hot is at operating temperature and requires no heat.

4. Verify the Reporter is sending 12V DC to the AC relay by going to the TESTING page and see if the AC relay makes a "click" sound. The AC electric relay should let out an audible click from within the Aqua-Hot cabinet

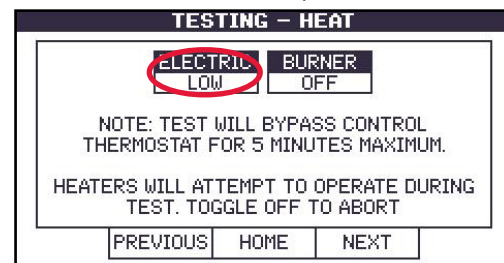

Figure 54

- If no "click sound", the AC relay and Reporter will need diagnosing.
- If there is "click" sound, continue troubleshooting the element.

5. Verify the electric element is receiving adequate AC power with an AC voltmeter. Remove the AC access cover and test for 110V AC power at the terminal block. If there is no voltage at the terminal block, there is an issue inside the motor home.

6. Verify the element's amp draw is between 11.2 - 13 amps.

7. Check the element's wires for continuity:

- Disconnect the motor from shore power, or shut off the generator.
- Disconnect the wires from the element and the AC

Electric Element

terminal block.

- Check the black and white wires at the terminal block for continuity.
8. Check the element for functionality by testing resistance. Using an ohmmeter, the element should be between 8.5 - 9.5 ohms. If not, follow the replacement procedure to replace the element.

Replacement Procedure:

1. Ensure that the Aqua-Hot has been completely shut down and that all power sources have been disconnected. Make sure the boiler tank is adequately cooled.
2. Drain the antifreeze and water heating solution from the boiler tank using the drain valve.
3. Remove the AC access cover.
4. Remove the two wires secured to the defective electric element by releasing the screw terminals.
5. Using a 1-½" socket, remove the defective element from the Aqua-Hot's boiler tank.
6. Install the replacement 1650W element into the boiler tank ensuring that the "up" lettering on the element is installed in the proper position.
7. Connect the wires removed from the defective element to the replacement element and tighten the screw terminals.
8. Reinstall the AC access cover.
9. Refill the boiler tank with the previously drained antifreeze and water heating solution.

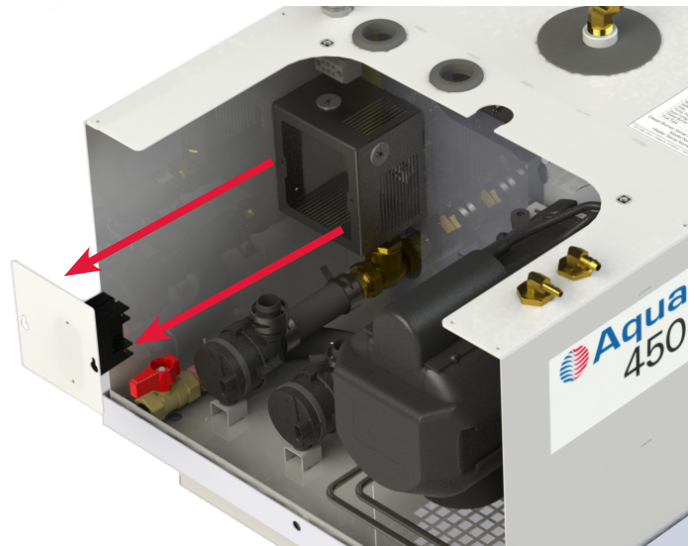

Figure 56

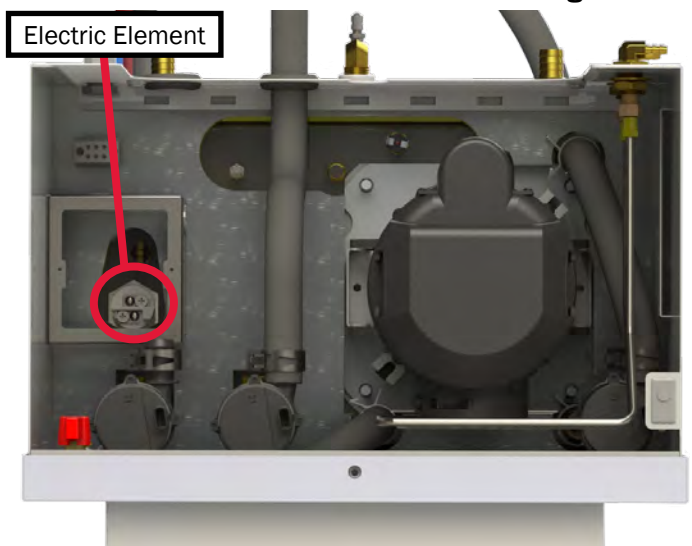

Figure 57

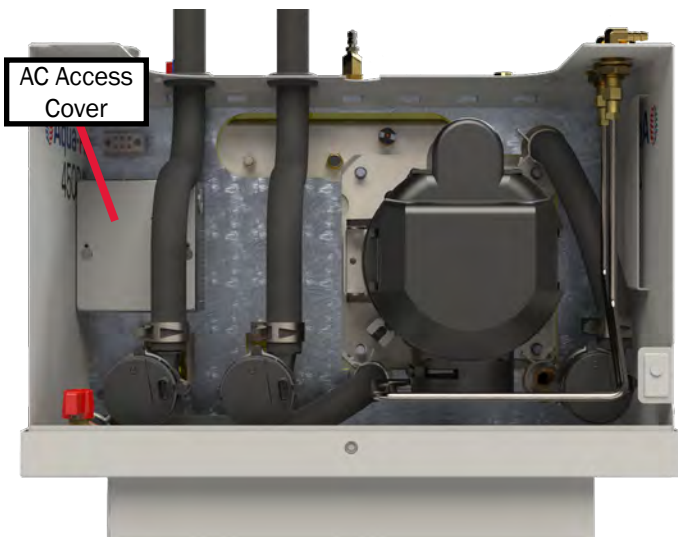

Figure 55



Figure 58

AC Relay

Introduction:

The AC relay is an electric where DC circuit from the Reporter determines whether AC power is permitted to flow to the electric heating element. This allows the Reporter to switch the electric heating element on and off in conjunction with the interior switch panel and ETS Module/control thermostat even though the electric heating element is on a separate circuit.



Figure 59

Begin troubleshooting the AC relay if the electric heating element fails to operate.

Troubleshooting Guidelines:

The following conditions must be met before the electric heating element can be diagnosed, and if necessary, replaced.

- The fluid expansion bottle is filled to at least the “COLD” mark.
- Verify that all in-line fuses are functional.
- The AC high-limit thermostat is operating and not tripped.
- Ensure that the unit is completely cool.
- Ensure that DC electrical power is supplied to the Aqua-Hot.
- Ensure that AC electrical power is supplied to the Aqua-Hot’s electric element.

If any of the above conditions are not met, correct them before continuing with troubleshooting. Results of the troubleshooting procedure cannot be verified if the conditions listed above are not fulfilled.

Troubleshooting Procedure:

1. Disconnect the AC power source to the motor home (unplug from shore power or shut off the generator).
2. Verify that the Electric shows ON on the Reporter.
 - If the interior switch is on, the Reporter is not showing the electric as ON, and the tank is below 215°F, the Reporter will need to be replaced.

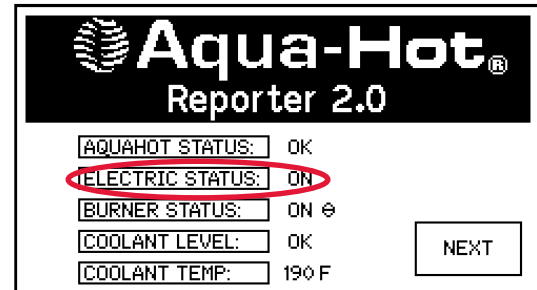

Figure 60

3. Using a voltmeter, check for 12V DC on pins 12 & 13 on the J2 plug of the Reporter.
 - If 12V DC are not present with the Electric status ON and the tank is below temperature, the Reporter will need to be replaced.
 - If 12V DC are present, locate the AC wires connected to the AC relay and remove the AC wires from the relay
 - Using an ohmmeter, check the AC relay pins for continuity. If no continuity exists, the AC relay will need to be replaced.

Replacement Procedure:

1. Ensure that the Aqua-Hot has been completely shut down and all power sources have been disconnected.
2. Make sure the motor home is not connected to shore power and the generator is not connected during this procedure.
3. Remove the AC access cover.
4. Release the wires from the defective AC relay by removing the corresponding screw terminals.
5. Remove the defective relay by drilling the rivets that hold the defective relay in place.

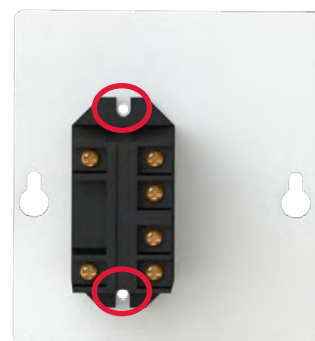

Figure 61

6. Rivet the replacement AC relay to the AC access cover.
7. Using the schematic on page 100, connect the wires previously removed to the replacement AC relay.
8. Reinstall the AC access cover and test for proper operation.

Aqua-Hot Reporter

Introduction:

The Aqua-Hot Reporter is a new generation of command and control module which manages all functions of the Aqua-Hot from start-up to shutdown. The previously used electronic control board has been retired on new units in favor of the Reporter.



Figure 62

Electrical Specifications:

The Reporter contains a single Amphenol ATP family connector that serves as the power connection to the coach side 12V DC power system. Mating connection components are not supplied by Aqua-Hot. Compatible part numbers and manufacturers are supplied below. The Reporter must be operated to the below listed specifications.

Minimum Voltage.....	11.0V DC
Maximum Voltage.....	15.0 V DC
Minimum Current.....	75mA
Maximum Current.....	15A

Please note that the minimum current rating is the minimum requirement for what will operate the Reporter. Operating at this current rating will not provide sufficient power to any components dependent upon the Reporter.

Input Load currents

Zone Thermostats (each).....	appx. 1mA
Diesel Burner Switch.....	appx. 1mA
Electric Element Switch.....	appx. 1mA
Low-Level Cutoff Switch.....	appx. 1mA
Control Thermostat (Reporter 1.0).....	appx. 1mA
Tank Temperature Sensor (Reporter 2.0).....	appx. 1mA
Low-Temperature Cutoff Thermostat.....	appx. 1mA

Output Load currents

Zone Fans (Reporter 1.0/all).....	3.0A max
Zone Fan 1 (Reporter 2.0).....	8.0A max
Zone Fans 2-5 (Reporter 2.0).....	5.0A max
Zone Fans (all).....	0.25A max
Circulation Pumps (each).....	2.0A max
AC Relay.....	0.5A max
Burner Power.....	6.0A max
Burner Master Control.....	2.0A max
Burner Thermostat Control.....	1.0A max

Connection Terminal Information

RV-C Mating Connection		
Mfg.	Part Number	Description
3M	37104-A165-00E-MB	RV-C Connection Housing

Reporter Power Connection		
	Deuthsche	Amphenol
Pins	1060-12-0222	AT60-12-0222
Housing	DTPO4-2P	ATPO4-2P
Wedge	WP-2P	AWP-2P

Harness Connections			
Mfg.	Part Number	Description	Mate
TE	1-480706-0	09P UMNL Plug	J1
TE	1-480710-0	15P UMNL Plug	J2
3M	37104-2165-000 FL 100	CONN Plug 2MM 4POS 20-22 AWG	J3
TE	1-480708-0	12P UMNL Plug	J7
TE	1-480704-0	06P UMNL Plug	J8
TE	640582-1	08P UMNL Plug	J9

Sockets			
Mfg.	Part Number	Description	Mate
TE	350550-1	UMNL SOK 20-14 TIN/PHBZ L/P	J1 J2 J3 J7 J8 J0

Socket Crimping Tool		
Mfg.	Part Number	Description
TE	90547-1	ASSY Pro-Crimper M-N-L

NOTE: For networked control of the Reporter, Aqua-Hot requires system integrators ensure that individual commands are received and processed. Aqua-Hot requires that commands be repeated or confirmed so that if a single message were dropped, or if there is a brief network disturbance, the Reporter would get into the correct state as soon as the disruption was removed.

The Aqua-Hot Reporter monitors the heating system and handles all logic relating to safeties and heating control. As such, the system integrator is required to display all pertinent status information but not use that information to lock out operation or add additional safety layers that could impact the end of operation if a message from the Reporter was missed.

Replacement Procedure:

1. Ensure that the Aqua-Hot has been completely shut down and that all power sources have been disconnected.
2. Remove the four screws that are securing the Reporter.
3. Disconnect the positive and ground wires from the back of the Reporter.
4. Disconnect the Aqua-Hot terminal plugs by pushing on the tabs and pull away from the Reporter.
5. Disconnect the coach-side connections by loosening the screws on each plug and pull away from the Reporter.
6. Install each terminal strip and plug back to the Reporter and tighten the screws for the coach-side connections.
7. Connect the ground wire, followed by the main 12V DC power wire to the replacement Reporter.
8. Reinstall the replacement Reporter and secure with the four screws previously removed.
9. Ensure that all electrical connections are made with the Aqua-Hot and the onboard RV-C system (if applicable) and that power is supplied to the new Reporter.

10. Tap the Reporter screen to wake the unit. Select “NEXT”.

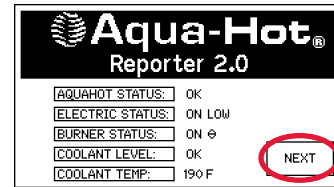

11. Press and hold “S/N” for 6 seconds and release. You will be displayed with an option screen.

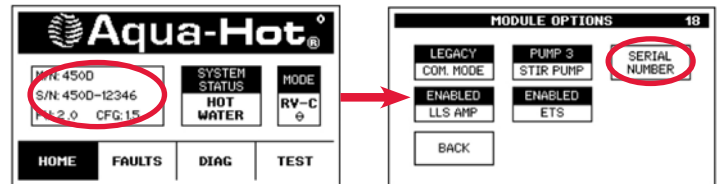

12. Tap “SERIAL NUMBER”. The data entry pad will be displayed and here you can enter the serial number shown on the Aqua-Hot Identification label. Tap “ENTER”. The Reporter will not accept invalid serial numbers.

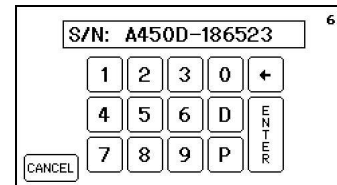

Reporter Back Side

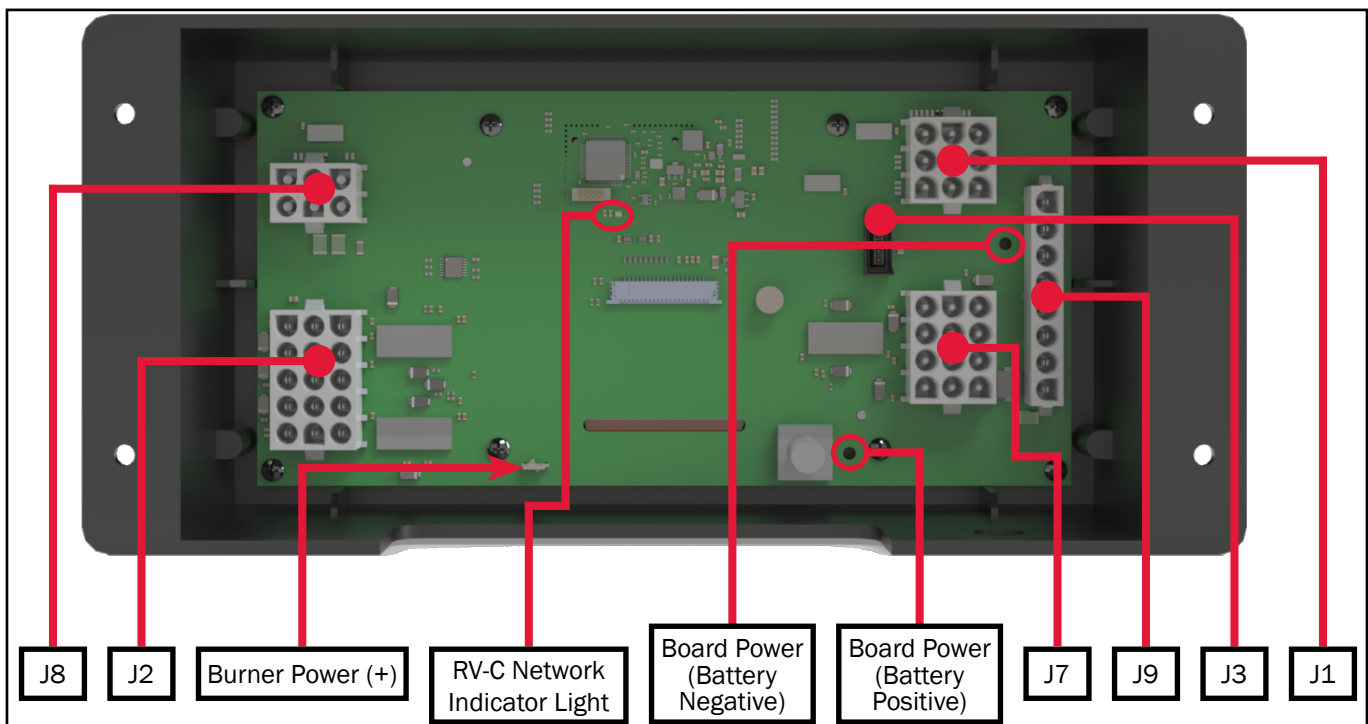

Figure 63

Fault Conditions

Introduction:

The Reporter contains five distinct categories of fault conditions which will assist in diagnosing and repairing the Aqua-Hot should problems arise. Low-voltage, over-temperature, and over-voltage fault conditions will be accompanied by the component which triggered the fault. It is best practice to record all conditions at the “FAULT” screen. Fault conditions are also recorded in the fault log on the “TEST” tab. When using the fault log, it is important to know that this log cannot be cleared, and may contain information on faults not pertaining to a present issue.

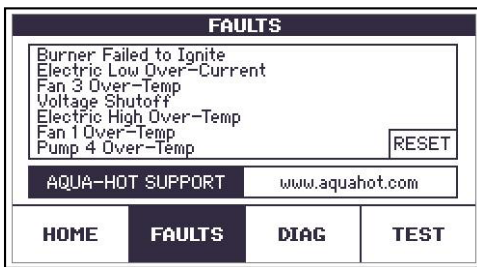

Figure 64

Reset Feature

The RESET button shown above on the Reporter fault screen can be used to reset the Reporter after a component has been changed or modified. Some components will require a full power-cycle in order to fully reset the Aqua-Hot system.

Over-Current

An over-current fault condition occurs when too much current is drawn by a component (output channel), usually a fan or pump. When an over-current condition occurs, the Reporter will deactivate the over-current component as a safety measure to prevent damage. This fault can only be cleared once the Reporter has been reset. Please note, that if the responsible component is not repaired or replaced, it can continually cause over-current fault conditions, thereby impacting the functionality of the Aqua-Hot unit.

NOTE: An overheat issue can also be caused by the engine pre-heat loop, especially if towing over mountain passes.

Over-Temperature (Reporter 2.0)

The Over-Temperature fault condition occurs when the tank temperature sensor indicates that the unit has overheated. An overheat is realized when the antifreeze and water heating solution within the Aqua-Hot exceeds 210°F.

Low-Voltage

The Reporter is designed to operate between 11V Direct Current (DC) and 16V DC. If the Reporter detects that it is receiving less than 11.8V DC, it will display a low-voltage fault. If the Reporter drops below 11.2V DC for more than 30 seconds, a safety mechanism will activate, shutting down the Aqua-Hot.

Low-Level Cut Off

Aqua-Hot units require a minimum amount of antifreeze in order to function correctly. Keep in mind that the exact fluid volume may differ depending on the layout of your coach. If the heater drops below the minimum fill level as indicated on the expansion bottle, the Reporter will shut down all fans, pumps, and heat sources until the unit has been refilled and the Reporter has been reset.

Ignition Failure

Ignition failure fault conditions will occur if the burner inside the heater fails to ignite. This is all the fault condition will display. Precise diagnosis herein will require in-depth troubleshooting.

Testing

The Reporter retains the functionality to independently activate certain components and sub-systems within the Aqua-Hot heater. The systems that can be independently activated are the burner, electric element, and burner indicator light. For testing procedures, only one system can be activated as independent components. These components and sub-systems will remain active for only five minutes, and are NOT a substitute for normal operation. Aqua-Hot Heating Systems is not liable for damages resulting from attempting to use testing functions in place of standard operation.

Pumps

Pumps on your heater can be independently activated using the Reporter. These can be used to verify functionality, or to purge fluid lines of air. Select each pump from the screen to activate. Keep in mind that these testing screens will ignore input from the fluid level sensor. On Reporter units with firmware version 1v7 and earlier, pump 3 will serve as the stir pump on the 400 Series.

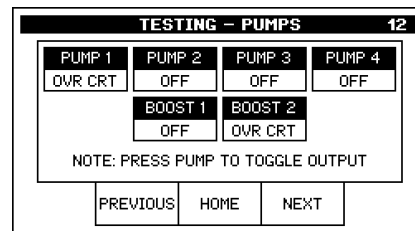

Figure 65

Fans

Using the “FANS” screen, it is possible to activate fans in each zone to test for functionality. This is similar to the pumps screen, allowing you to activate one or multiple fans at the same time by selecting the desired fan.

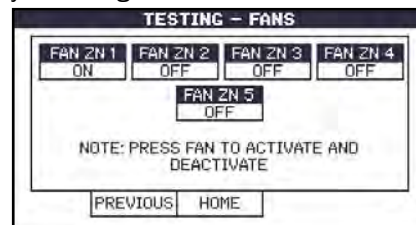

Figure 66

Heating

The heating tab will allow the burner, the burner indicator light, and the electric element to be activated and run for five minutes to test for functionality. During this time, inputs from the control thermostat are ignored to allow the test to take place. Do NOT activate the burner heat test without allowing the unit to cool. Not doing so could complicate further diagnosis and may cause irreparable damage to the Aqua-Hot.

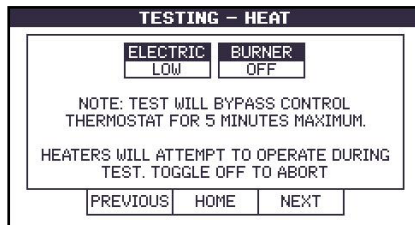

Figure 67

Diagnostic

The “DIAG” tab of the Reporter allows the user or technician to access input and output information to record communication information within the Aqua-Hot heater, and between the heater and the coach. This tab is read-only and will not allow the manipulation of the elements listed. There are four screens maintained under this tab: Inputs from Coach, Outputs to Coach, Inputs from Aqua-Hot, and Outputs to Aqua-Hot.

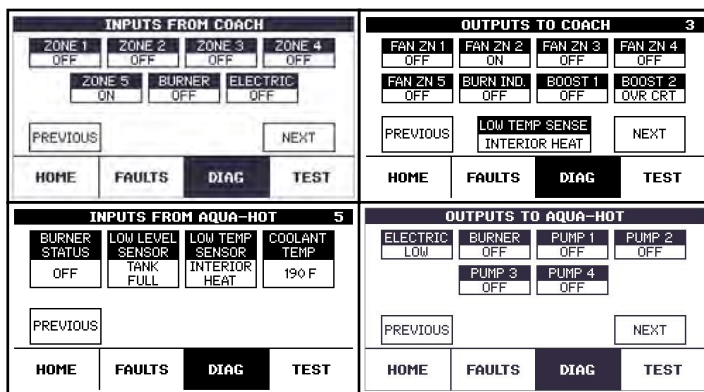

Figure 68

Manual Mode

The 2.0 Reporters with CFG 1.9 and greater come with a manual mode in case the general coach RV-C network fails. It will allow for limited operation while the larger network/module problem is addressed.

To determine the version of Reporter, the Reporter 2.0 modules are shipped with version decals affixed to the back of the circuit board, OR shown on the home screen - “FW: 2.0”.

This mode can be accessed under the test page of the Aqua-Hot Reporter (see below).

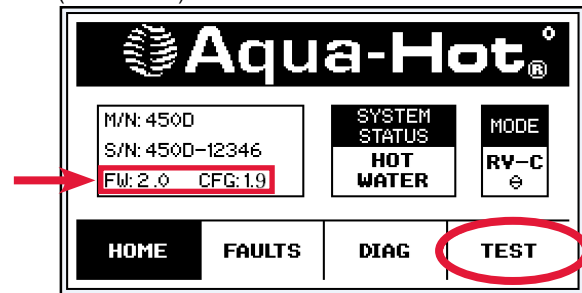

Figure 69

Once the test page is open, select the MANUAL MODE and select “NEXT”. Manual mode will continue to run for up to 3 days without any user intervention. Pressing the reset button at any time while enabled will reset the timer, and run for an additional 3 days.

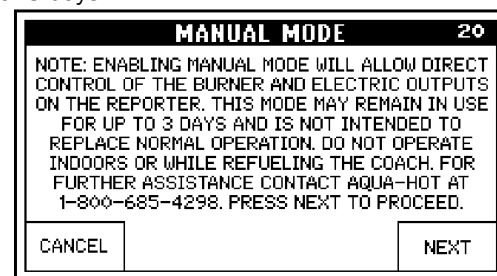

Figure 70

All heating zones are linked together and can be run at 25%, 50%, 75%, and 100% (as shown below). The burner and electric can be enabled or disabled. For all levels, there is a 10 minute duty cycle period that will allow Cozy fans to be on for the specified percentage of 10 minutes. Example, 25% would be on for 2.5 minutes, and then off for 7.5 minutes. It always starts with the on-cycle, then shuts off for the remainder of the 10 minute period.

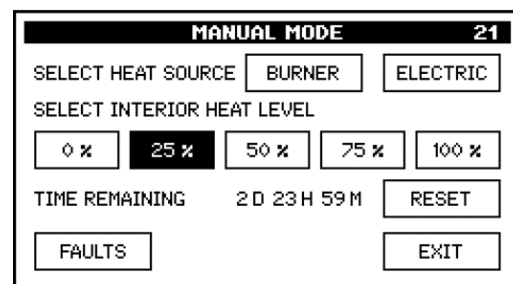

Figure 71

If the system power is cycled, the manual mode will be disabled and must be manually reactivated. Leaving the manual mode page will also disable manual mode and restore normal operation. Leaving manual mode should be done once the system failure has been resolved and normal operation can resume.

NOTE: If using the rocker switches, burner & electric switches must be toggled on/off after leaving Manual Mode.

Diesel Burner

Introduction:

The Aqua-Hot's diesel burner is a device that ignites a mixture of diesel fuel and air within a controlled setting to serve as a heat source. The flame is established in a combustion chamber within the Aqua-Hot's boiler tank, and the heat from the flame is transferred to the antifreeze and water heating solution where it can be used for each system of the Aqua-Hot - domestic hot water, interior heat, and engine preheat.

Diesel Burner ID Label

5000015A		Webasto <i>Feel the Drive</i>
Assembled in USA		
Heater Model	DBW2010.75	
Voltage/Power	12V/60W	
Output	13.2kW-45000Btu/h	
Fuel Type	Diesel No. 1/No. 2 and Artic	
Max. Operating Pressure	2 bar-29PSI	
		
Heater No. 90915E Vers. 75 Serial No.		727107
Year of Installation	18 19 20 21 22	

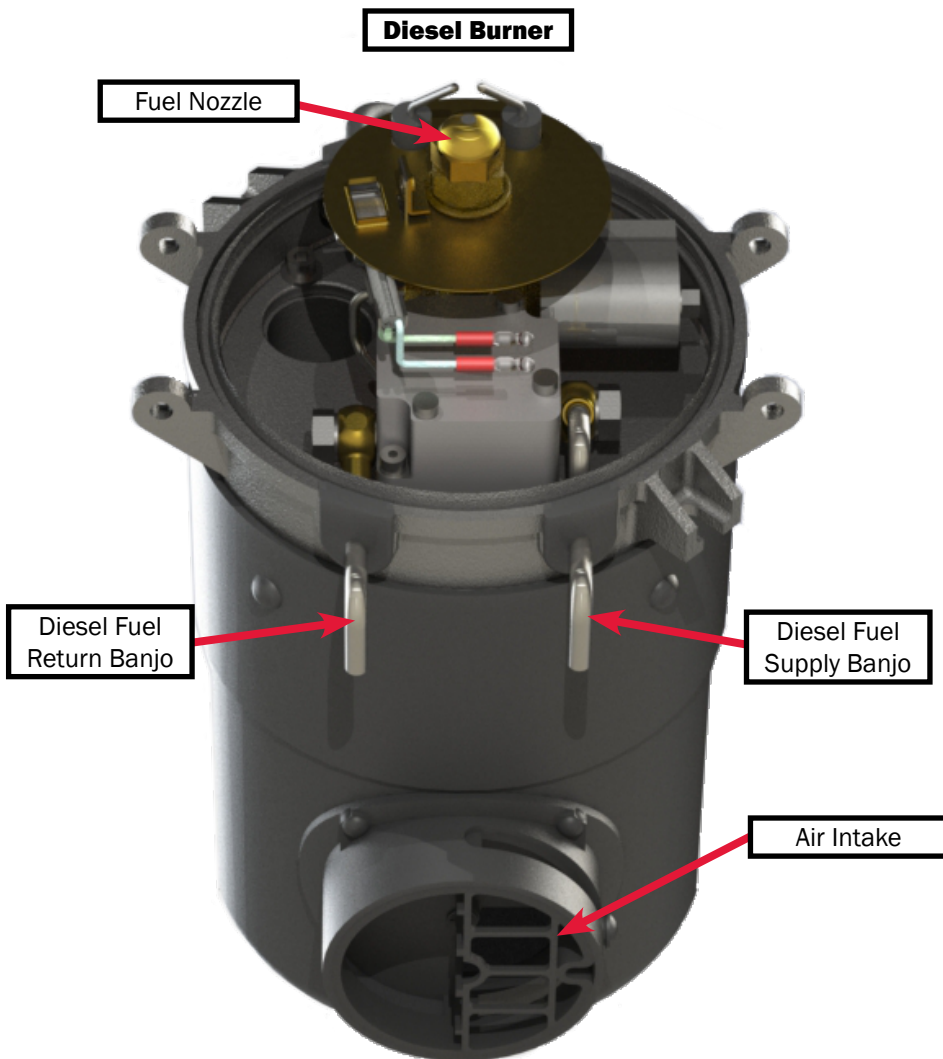
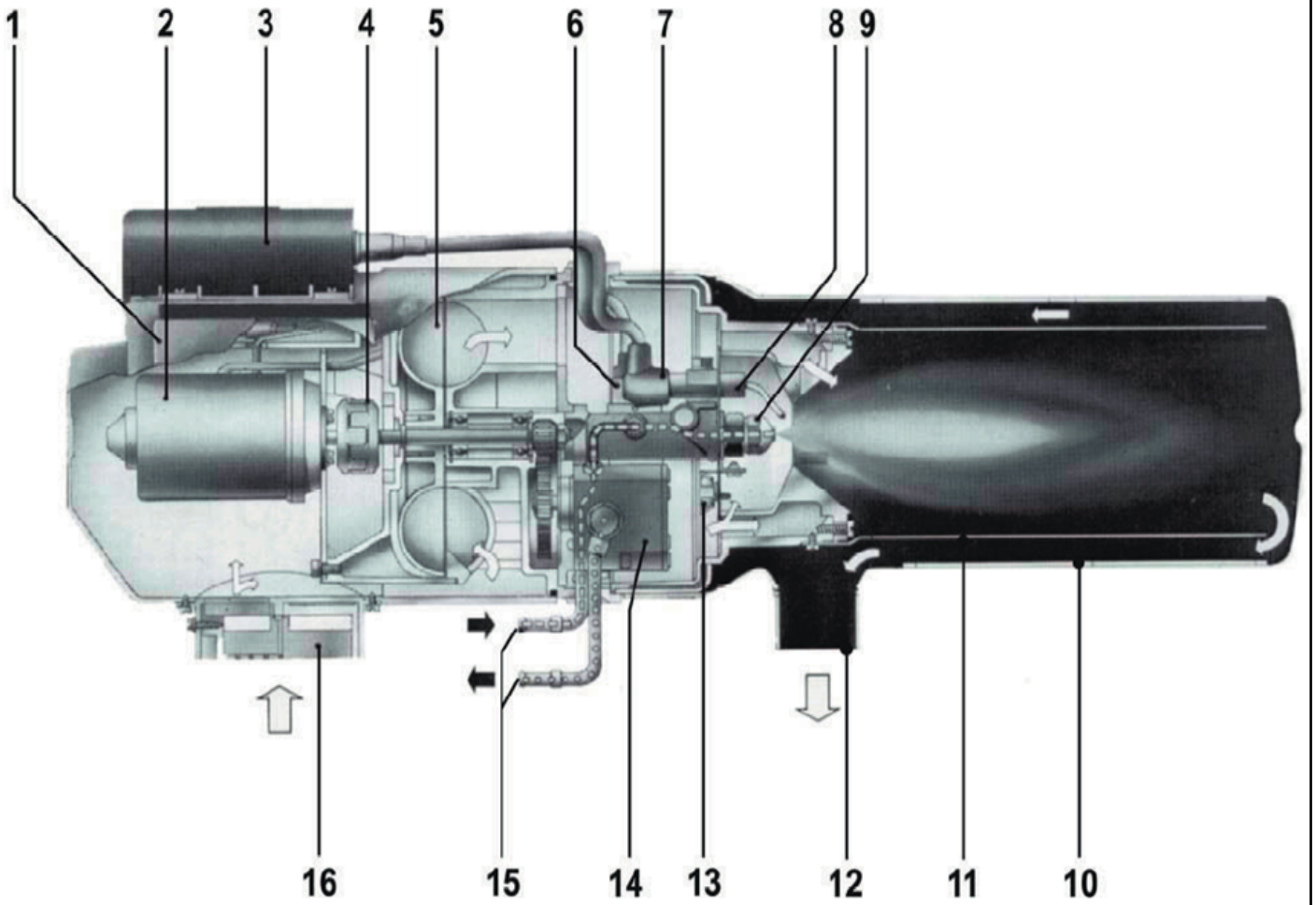
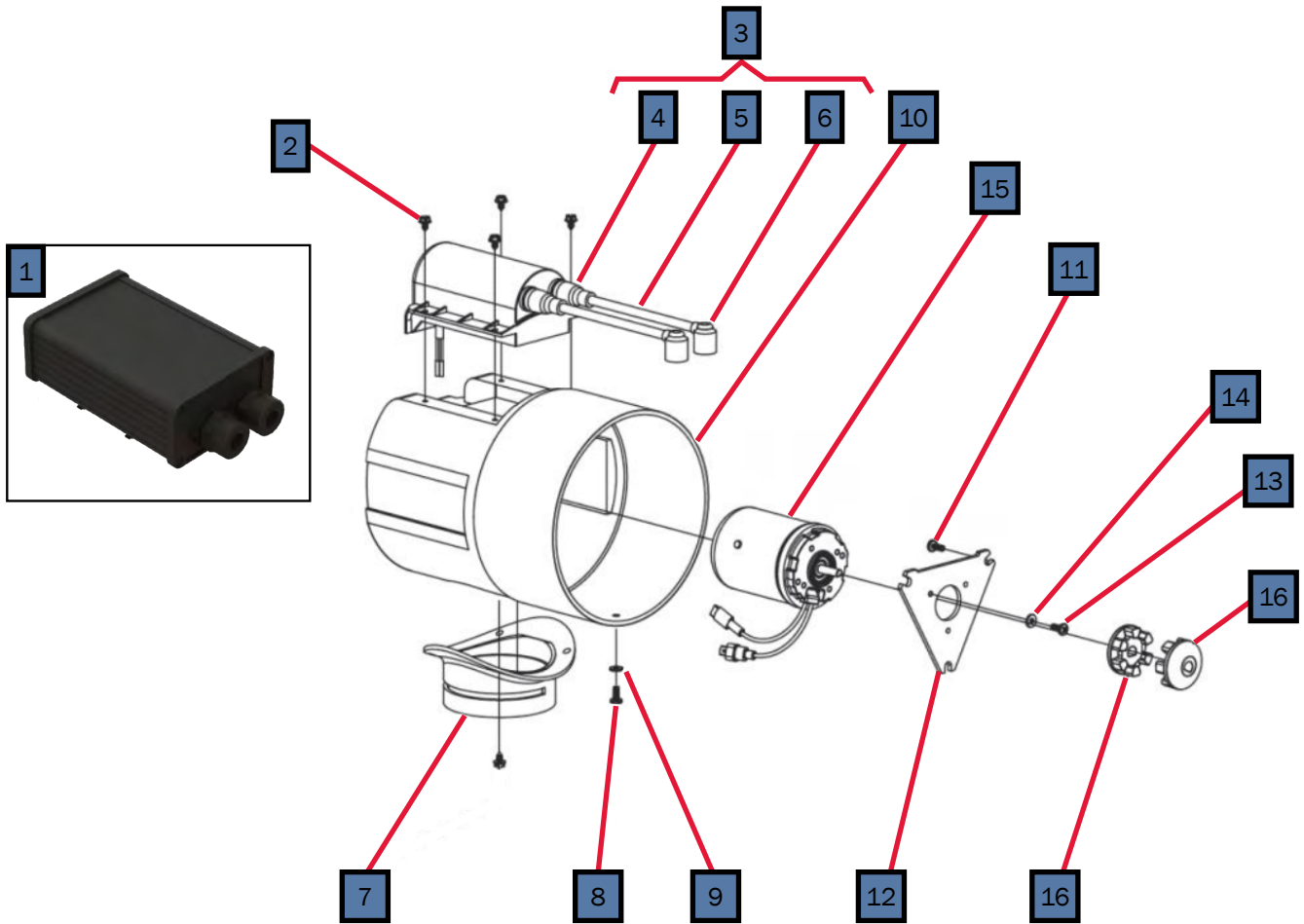

Figure 72

1. Diesel-Burner Controller
2. Motor
3. Ignition Coil
4. Clutch
5. Combustion Air Blower
6. Fuel Solenoid Valve
7. Electrode Boots
8. Ignition Electrodes
9. Fuel Nozzle

10. Heat Exchanger
11. Combustion Chamber
12. Exhaust Port
13. Flame Sensor
14. Fuel Pump
15. Fuel Tubes (Supply / Return)
16. Combustion Air Intake Port, with Adjustable Shutter





Torque Specs	
Item	Torque Value
2	2 Nm
7	1.0 +0.5 Nm
8	2 Nm (18 lb-in)
11	5 - 6 Nm(44 -53 lb-in)
13	5 - 6 Nm (44-53 lb-in)

Key	Part Number	Description
1	WPE-300-901	Webasto Diesel Burner Controller, 12V DC
2	WPX-470-562	Coil Mounting Screw (Consumable)
3	WPX-101-838	12V DC Ignition Coil
4	WPX-404-918	Ignition Wire Boot
5	WPX-178-624	Ignition Wire
6	WPX-176-494	Ignition Wire Boot Elbow
7	WPX-350-427	Combustion Air Intake Shutter
8	WPX-432-377	Protection Housing Screw
9	WPX-152-269	Protection Housing Star Washer
10	WPX-436-216	Motor Protection Cap
11	WPX-147-834	Blower Housing Flange Screw (Consumable)
12	WPX-425-060	Motor Mounting Plate
13	WPX-432-377	Motor Plate Screw
14	WPX-152-269	Motor Plate Washer Star
15	WPX-425-060	Combustion Air/Fuel Pump Motor, 12V DC
16	WPX-350-516	6mm Clutch Half

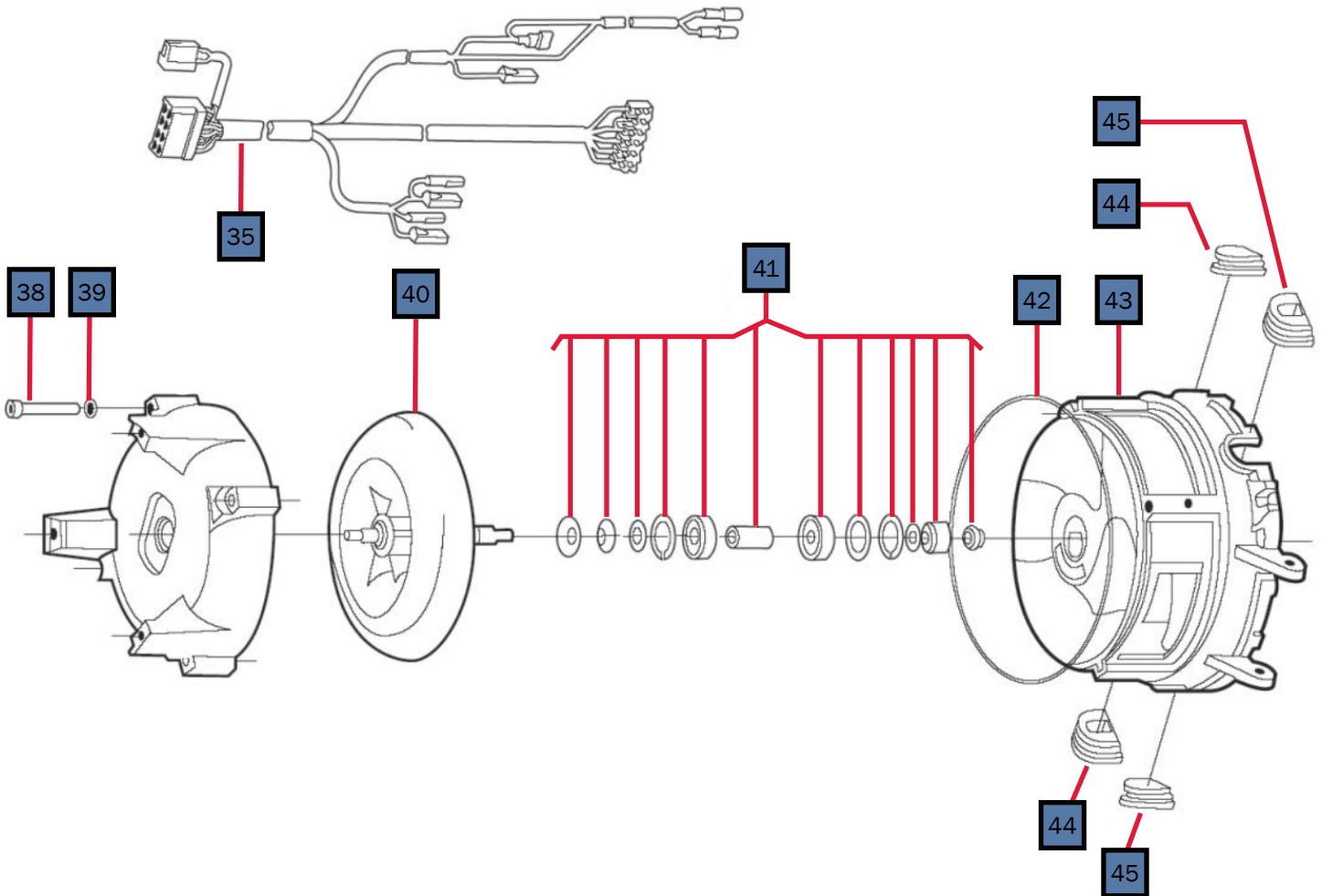

Torque Specs	
Item	Torque Value
38	5.5 - 6.5 Nm (48.5-57.5 lb-in)
40 (Fan Gap)	.457mm + .05mm (STANDARD SHIM STOCK) - 0.0mm
41 (nut)	

Key	Part Number	Date of Use	Description
35	WPX-434-795	Launch	C-Plug Harness
38	WPX-148-210	Launch	Blower Casting Screw (Consumable)
39	WPX-152-552	Launch	Blower Casting Lock Washer (Consumable)
40	WPX-373-001	Launch	Blower Wheel w/Shaft
41	WPX-378-313	Launch	Bearing Kit
42	WPX-412-244	Launch	O-Ring Blower Casting
43	WPX-225-67A	Launch	Blower Casting
44	WPX-298-964	Launch	Blower Casting Left Grommet
45	WPX-299-995	Launch	Blower Casting Right Grommet

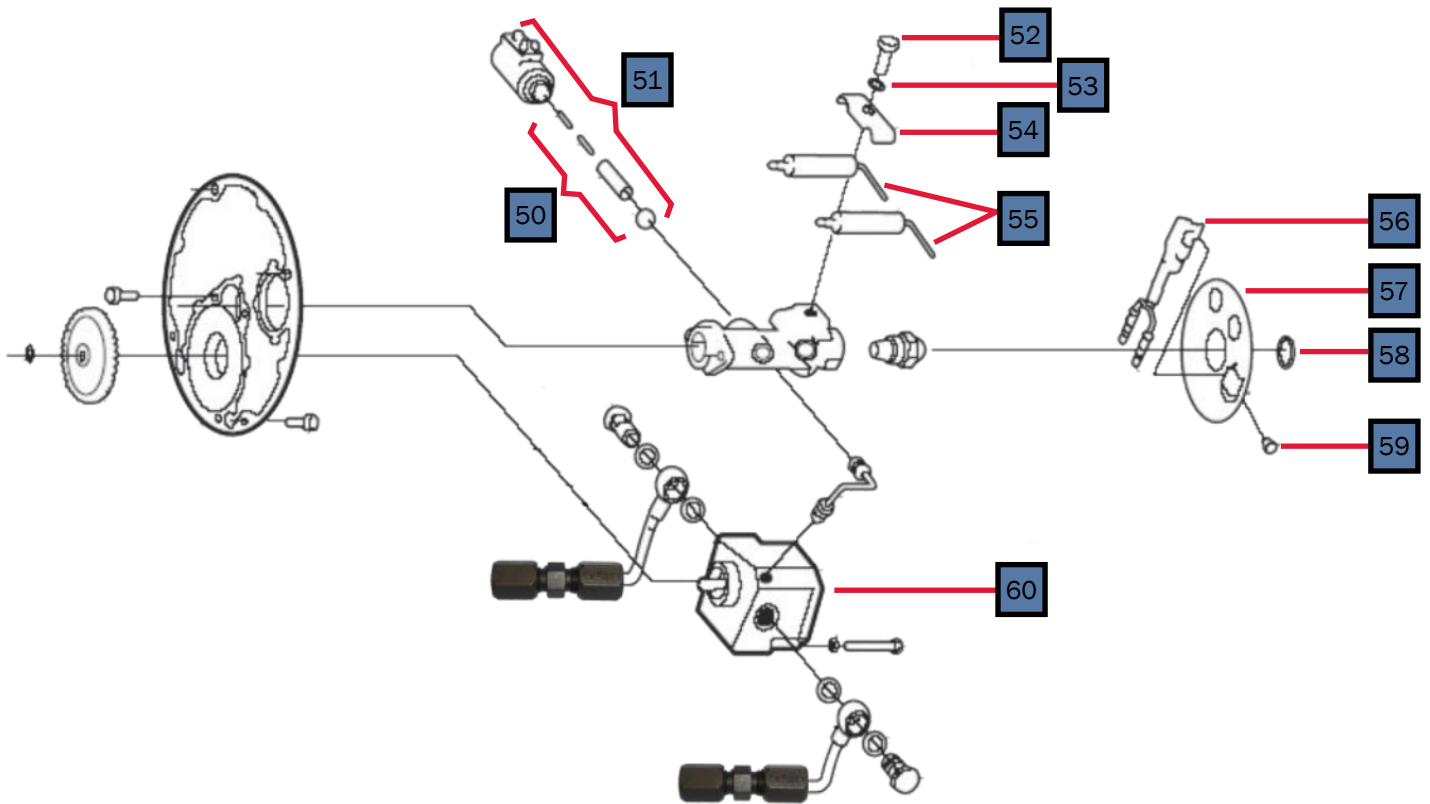

Torque Specs	
Item	Torque Value
50 (nut)	2 Nm
50 (fuel fitting to fuel tower)	11.5 Nm (8.5 lb-ft)
52	
59	5 Nm - 6 Nm (44-53 lb-in)

Key	Part Number	Description
50	WPX-322-083	Valve, Fuel Solenoid 12V DC
51	WPX-386-650	Valve, Fuel Solenoid Kit
52	WPX-267-279	Electrode Bolt
53	WPX-152-560	Washer, Lock, Electrode (Consumable)
54	WPX-278-971	Electrode Clamp
55	WPX-274-313	Ignition Electrode
56	WPX-638-78A	Flame Sensor
57	WPX-887-71A	Photo Disc
58	WPX-453-048	Clip, Retaining, Photo Disc
59	WPX-147-699	Flame Sensor Screw
60	WPX-503-03A	Fuel Pump Kit

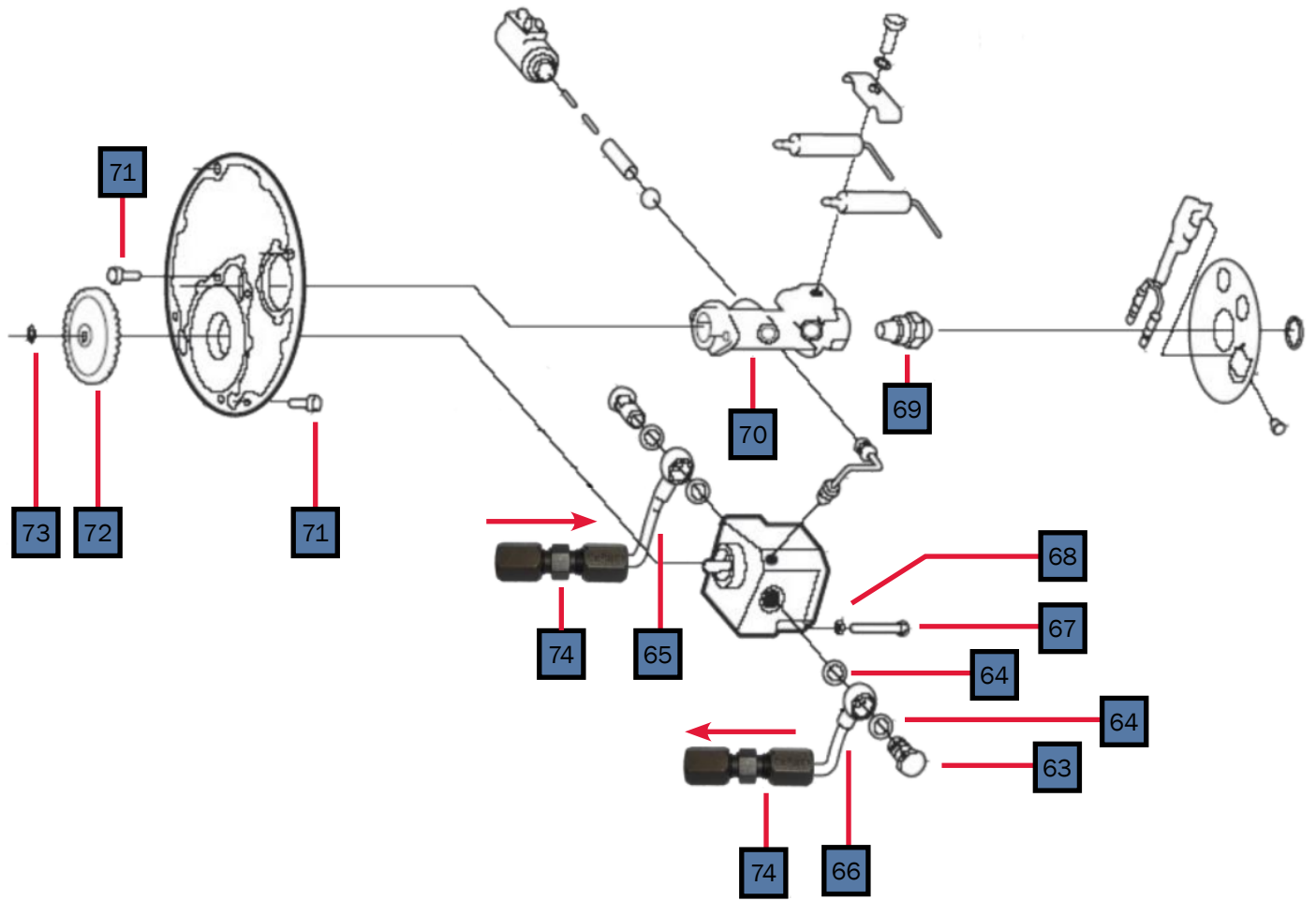



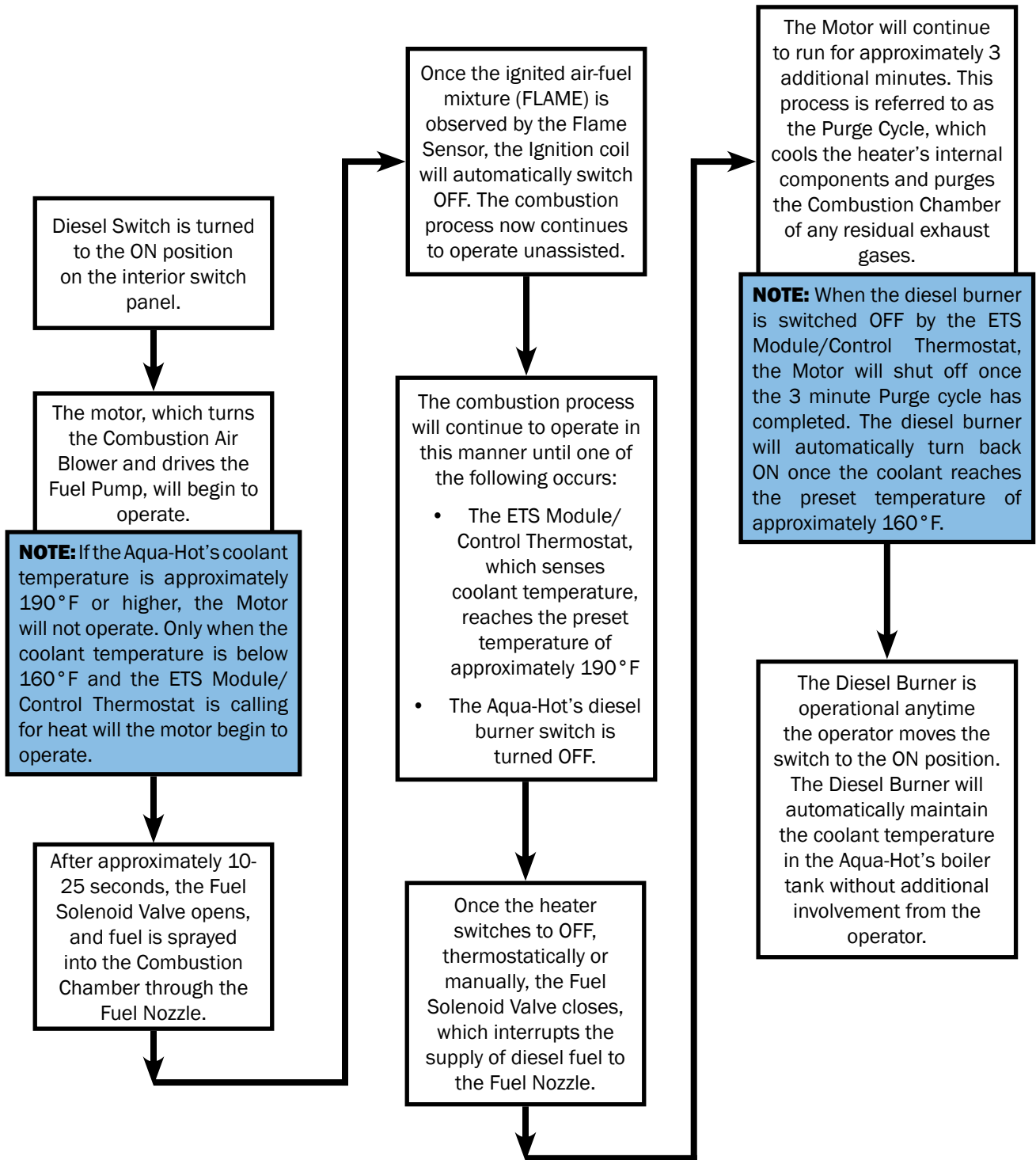

Torque Specs	
Item	Torque Value
63	15 ± 1.5 Nm
67	3 Nm
69	20 Nm
71	5.5 Nm
72	Use grease type : ISOFLEX LDS 18 Special A Lubricant P/N 143820 (45gram tube)
74	

Key	Part Number	Description
63	WPX-150-754	Banjo Bolt
64	WPX-151-157	Copper Ring Gasket
65	WPX-661-45A	DBW 2010 Fuel Supply Banjo Pipe (w/ straight tube)
66	WPX-661-44A	DBW 2010 Fuel Return Banjo Pipe (w/ straight tube)
67	WPX-277-282	Fuel Pump Mounting Screw (Consumable)
68	WPX-152-544	Fuel Pump Lock Washer (Consumable)
69	WPX-886-41A	Fuel Nozzle 0.35GPH
70	WPX-412-198	Brass Fuel Nozzle Manifold
71	WPX-277-150	Nozzle Stand Screw Plate (Consumable)
72	WPX-371-289	Nylon Fuel Pump Gear
73	WPX-152-390	Gear Snap Ring
74	FLX-421-010	Hex Union Tube Fitting

Diesel Burner Operational Flow Chart



KEY

	Diesel Fuel Spray	
	Combustion Air	 Exhaust Gases
	The particular component begins to operate.	
	The component is currently operating.	

Diesel-Burner Operation

1

When the *Diesel* switch is turned **ON**, the *Motor* and *Combustion Air Blower* begin to operate. This process is referred to as the prime-cycle.

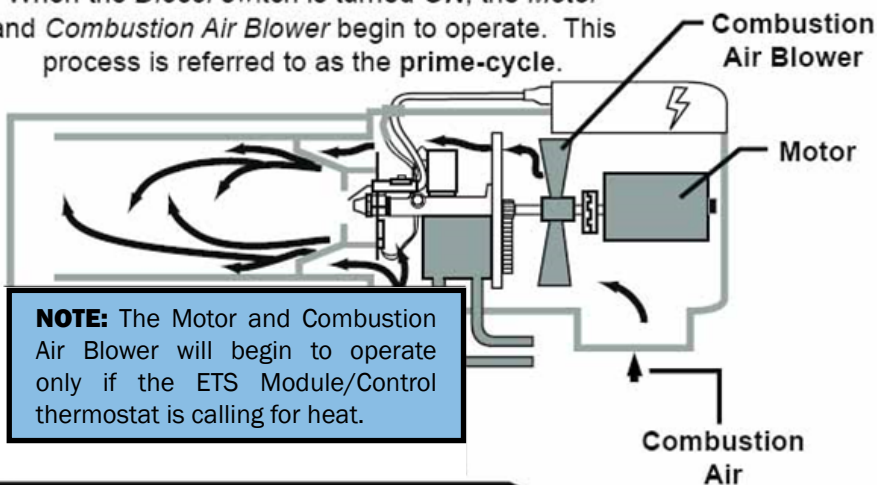



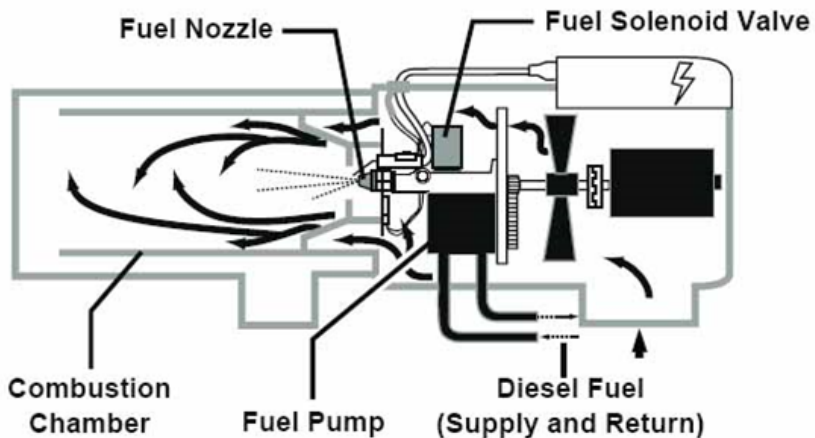

NOTE: The Motor and Combustion Air Blower will begin to operate only if the ETS Module/Control thermostat is calling for heat.

2

The *Fuel Pump* builds up pressure against the *Fuel Solenoid Valve*. After approximately 10-25 seconds, the *Fuel Solenoid Valve* opens, and fuel is released into the *Fuel Nozzle*, then sprayed into the *Combustion Chamber*.



KEY

-  Diesel Fuel Spray
-  Combustion Air
-  Exhaust Gases
-  The particular component begins to operate.
-  The component is currently operating.

Diesel-Burner Operation, continued

3

The *Ignition Coil* produces a high voltage spark, which is transferred across the *Ignition Electrodes*. The incoming air-fuel mixture is then ignited, creating combustion.

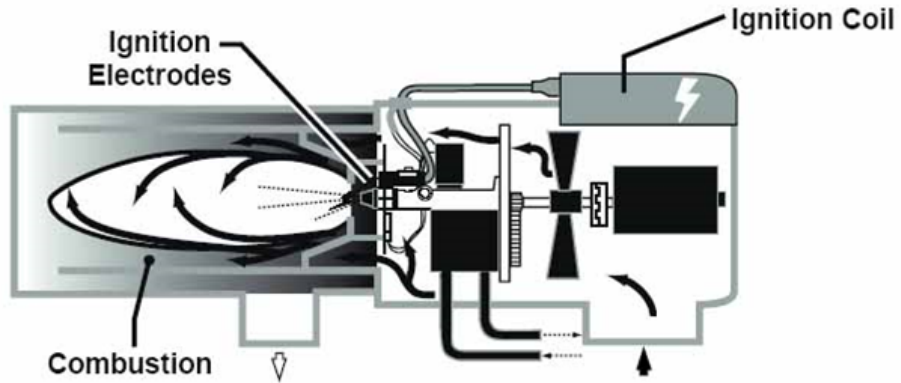



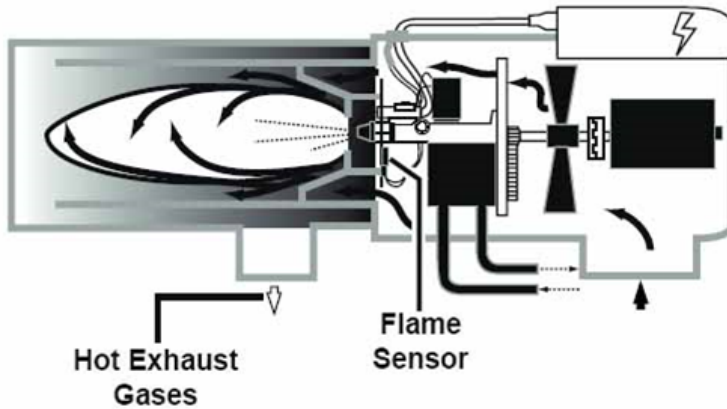

4

The combustion's flame is detected by the *Flame Sensor* and the *Ignition Coil* is then automatically switched off (no more spark across the *Ignition Electrodes*).



KEY

-  Diesel Fuel Spray
-  Combustion Air 
-  The particular component begins to operate.
-  The component is currently operating.

Diesel-Burner Operation, continued

5

The *Diesel-Burner* will continue to produce heat in this manner until it is switched off either manually or by the *VDC / VAC Control Thermostat*, which occurs when the coolant temperature in the Aqua-Hot's *Boiler Tank* reaches 190 (+/- 5) degrees Fahrenheit.

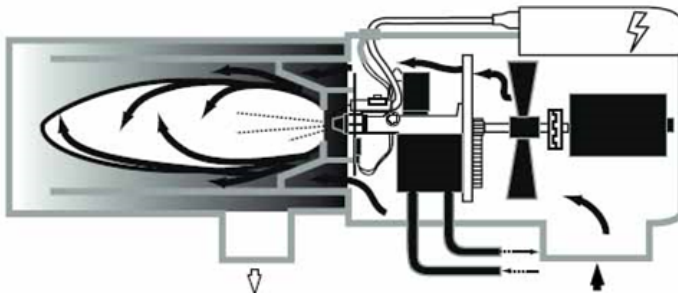

6

Once the *Diesel-Burner* has switched **OFF**, the *Motor* and *Combustion Air Blower* will continue to operate for approximately 2-3 minutes. This process is referred to as the **purge-cycle**.

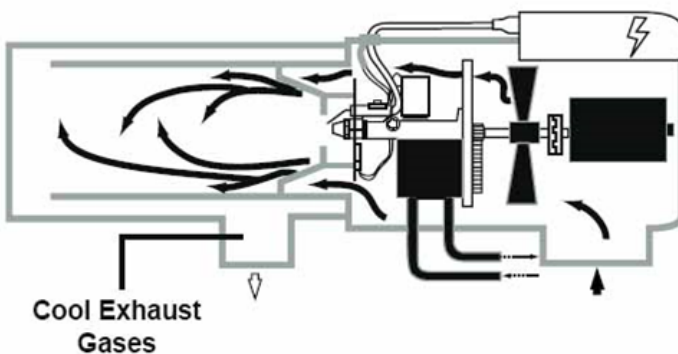

NOTE: Whenever the Diesel Burner is switched OFF by the Control Thermostat/ETS Module, it will automatically be reactivated once the Aqua-Hot boiler tank's coolant reaches the present temperature of approximately 160° F (±5°).

Instructions for Detaching the Diesel Burner

! WARNING

Be sure to move the diesel burner's switch on the interior switch panel to the OFF position and disconnect the diesel burner's power supply before detaching the diesel burner from the Aqua-Hot. Failure to turn off the diesel burner and disconnect power could result in serious bodily injury.

! CAUTION

Be sure to clamp off the Fuel Supply and Return lines at the ports on top of the Aqua-Hot prior to beginning this replacement procedure.

Step 1: Turn off the diesel switch

Light on the interior switch panel should turn OFF when switch is turned to OFF. Or the burner status should show OFF on the coach interior control panel.

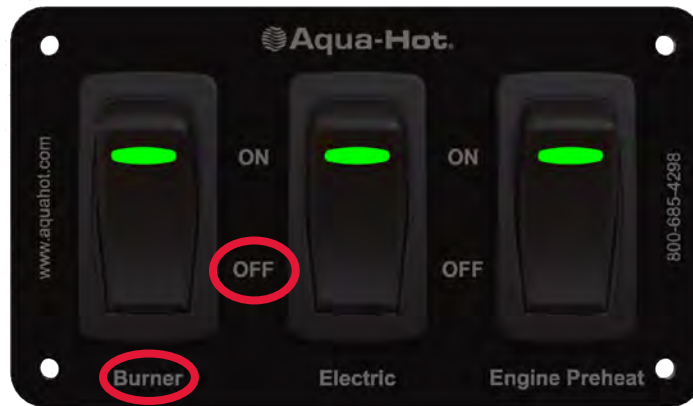

Figure 73

Step 2: Remove the Access Cover

Locate the bolt securing the access cover in place, unscrew the bolt.

Remove the access cover.

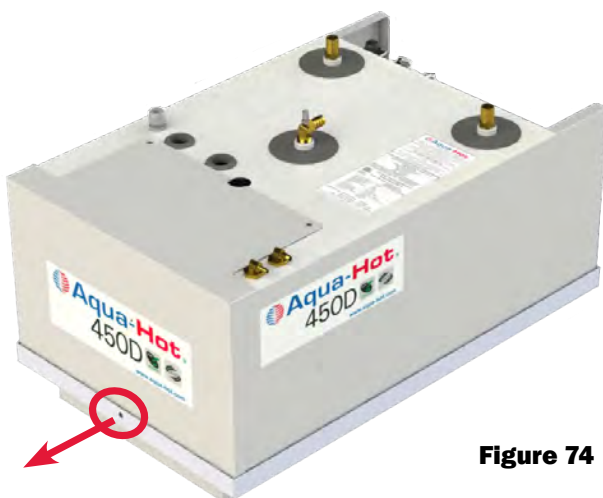

Figure 74

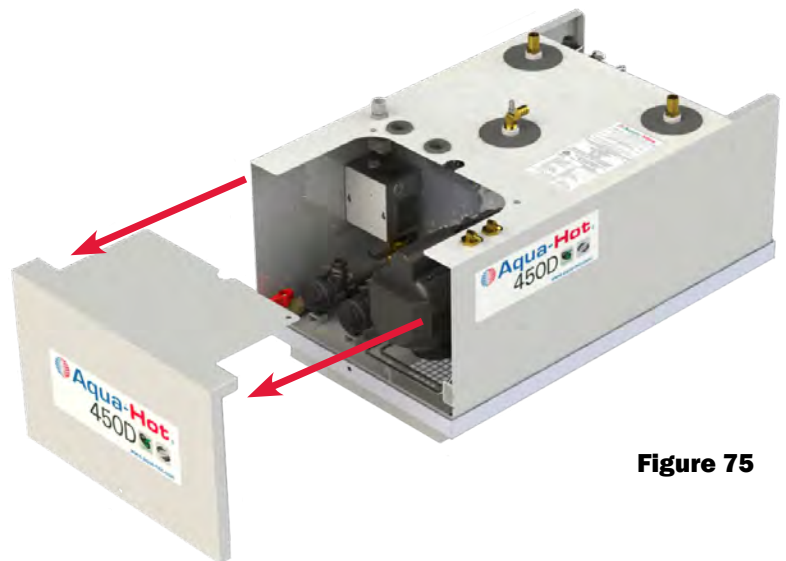

Figure 75

Step 3: Disconnect the Diesel Burner's Controller

Locate the controller and disconnect both plugs.

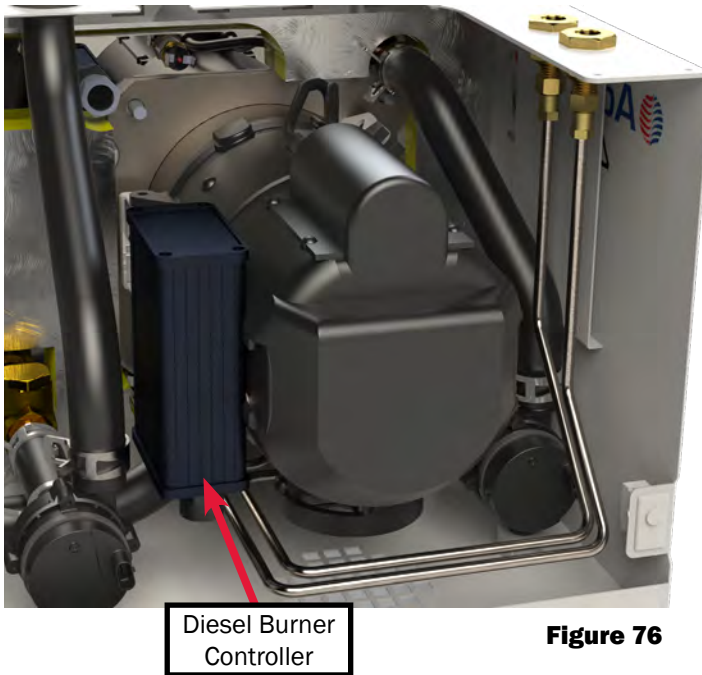

Figure 76

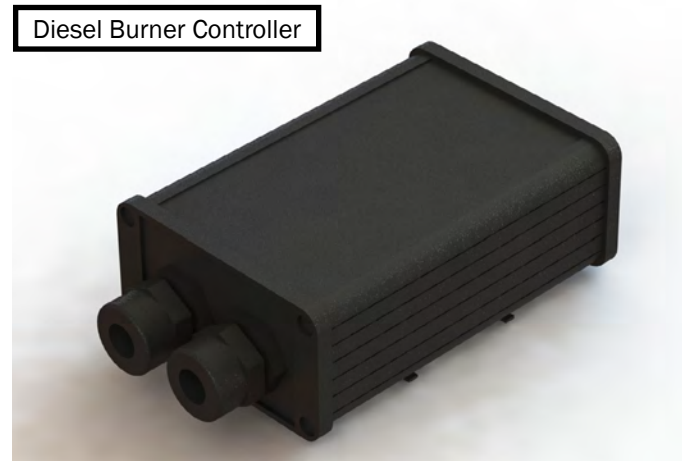

Figure 77

Step 4: Remove the fuel lines from the Aqua-Hot

Locate where the fuel lines on the diesel burner connect to the Aqua-Hot bulkhead fittings.

Using a $\frac{7}{16}$ " wrench, loosen the nuts securing each fuel line to the Aqua-Hot.

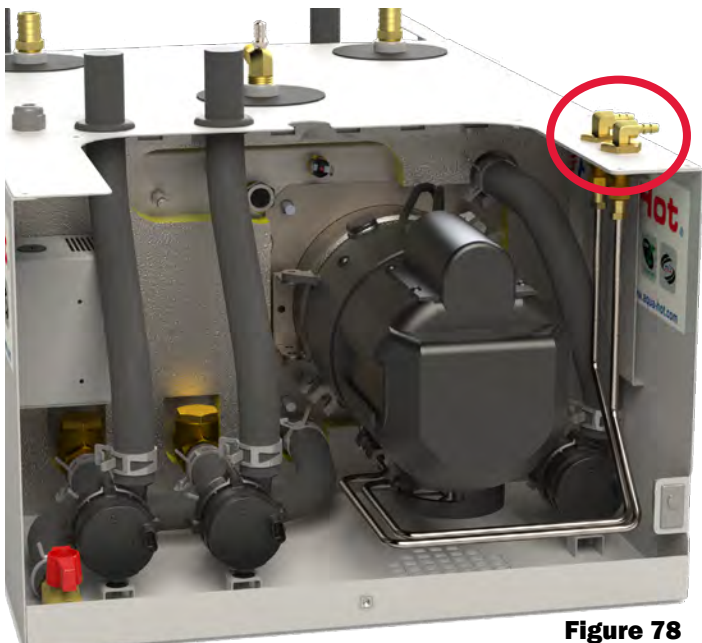

Figure 78

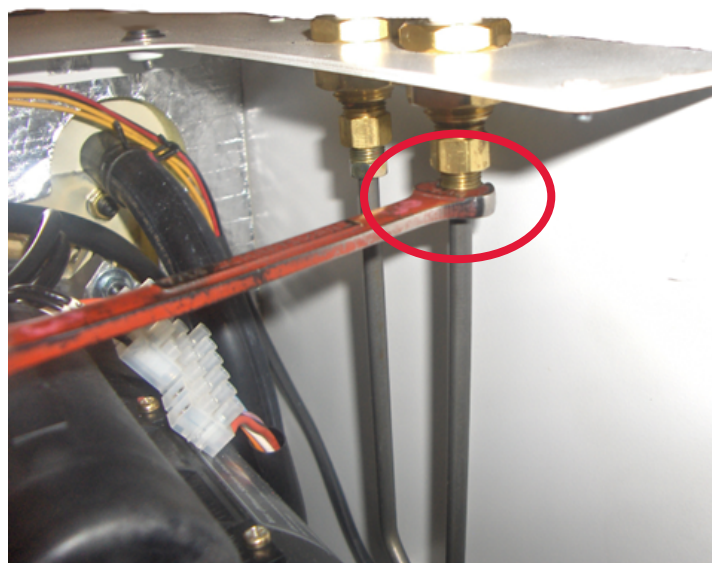

Figure 79

Step 5: Remove the Diesel Burner from the Aqua-Hot

The diesel burner is secured to the Aqua-Hot with two nuts that can be loosened, and swung out of the way by using a 10mm socket wrench with a 10" long extension.

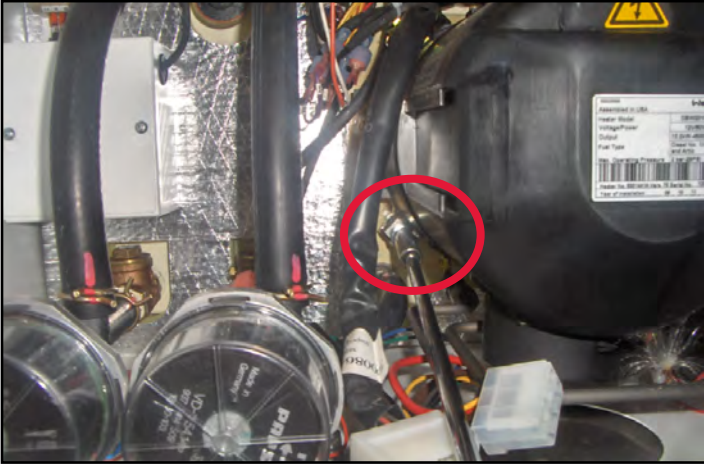

Figure 80

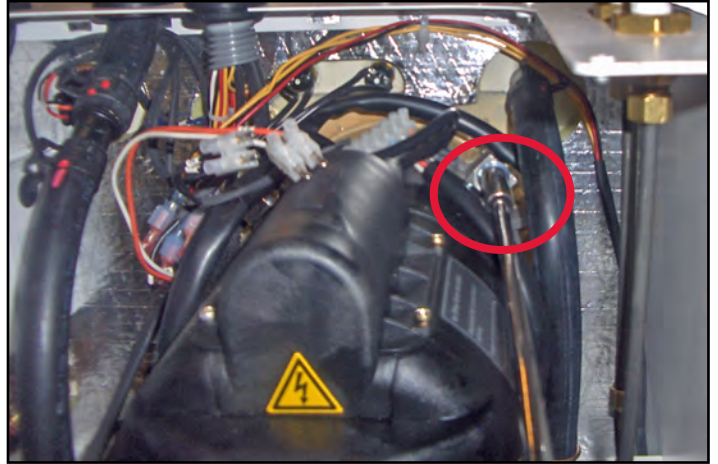

Figure 81

Carefully pull the diesel burner away from the Aqua-Hot 4 to 5 inches before rotating the burner up, and then remove.



Figure 82

Reattaching the Diesel Burner to the Aqua-Hot

CAUTION

When reattaching the diesel burner, be sure to properly align the diesel burner before tightening the eye-bolt nuts. Visually inspect all the rubber grommets on the top and bottom of the burner's cast-aluminum blower casing to ensure they are in place. **DO NOT** over-tighten the eye-bolt nuts. Torque specifications are 20-40 in-Lb. An improper alignment or over tightening of the eye-bolt nuts can cause damage to the burner's cast-aluminum blower casing.

Step 1: Reattach the Diesel Burner to the Aqua-Hot

The diesel burner is secured to the Aqua-Hot with two eye-bolt nuts that can be swung into place, after the diesel burner has been properly aligned and set in place.

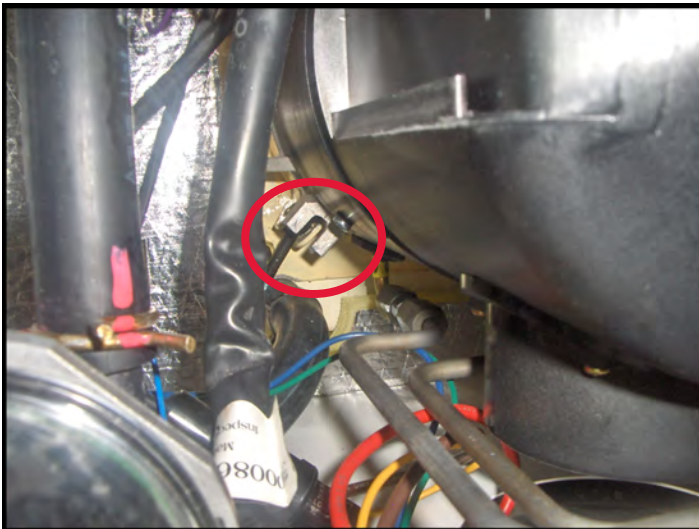

Figure 83

The eye-bolt nuts can then be tightened by using a 10mm socket with a 10 inch long extension. Use extreme caution when tightening down the eye-bolt nuts. Over-tightening the eye-bolt nuts can cause the aluminum blower casing to crack. (Torque Specifications are approximately 20-40 in-lbs.)

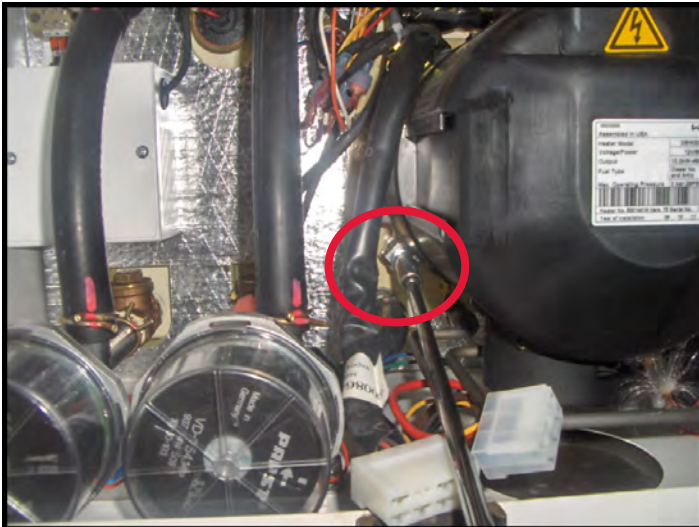

Figure 84

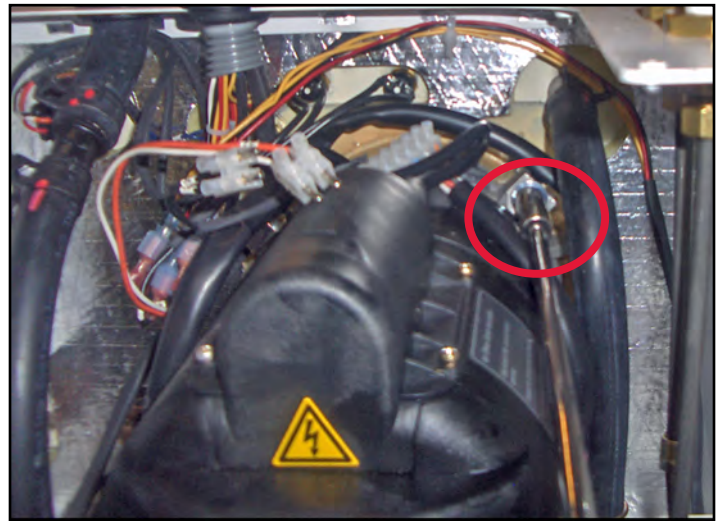

Figure 85

Step 2: Reattach the fuel lines to the Aqua-Hot

Align the fuel lines on the diesel burner with the fittings on the Aqua-Hot, and using a $\frac{7}{16}$ " wrench, tighten down both the supply and return fuel fittings.

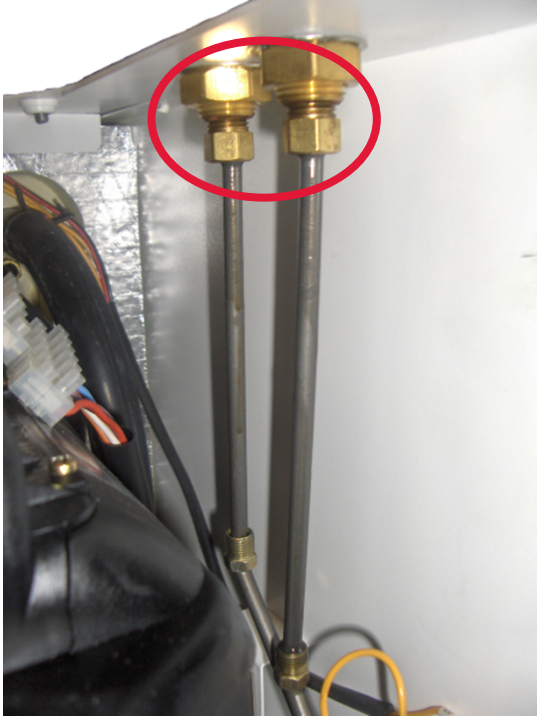

Figure 86

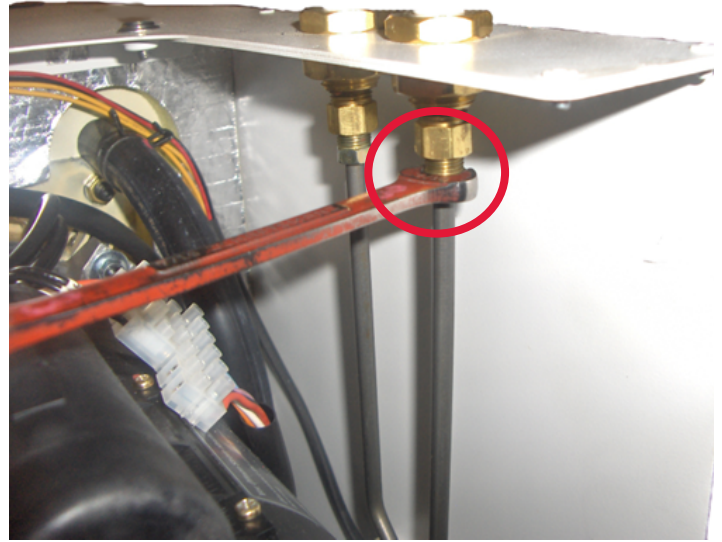

Figure 87

 **CAUTION**

Be sure to remove the clamps off of the fuel supply and return lines at the ports on the top of the Aqua-Hot prior to starting the diesel burner, or serious damage will occur to the diesel burner's fuel pump.

Step 3: Reconnect the Controller and Mount

Locate the diesel burner's Controller and connect both plugs that were previously disconnected.

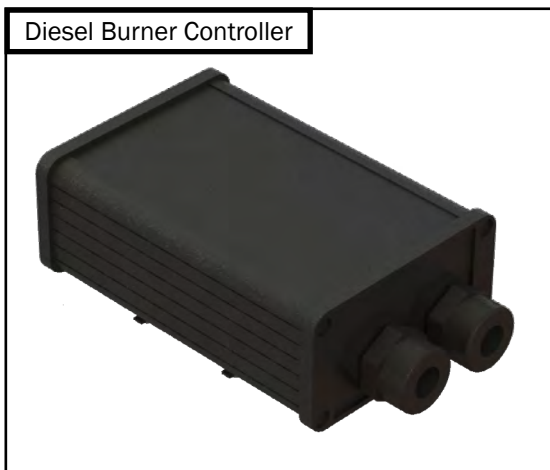

Figure 88

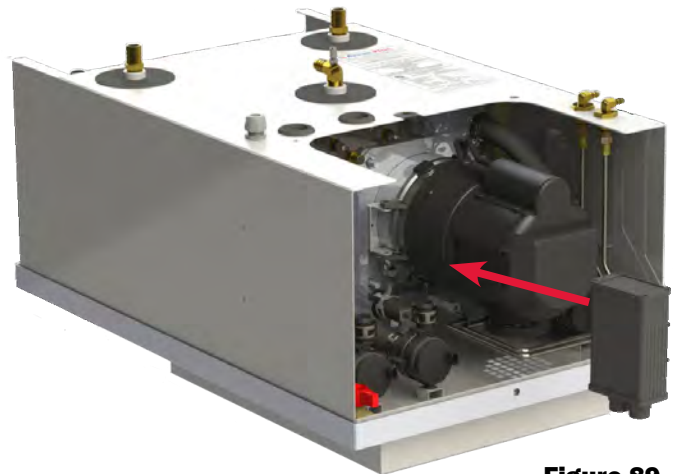
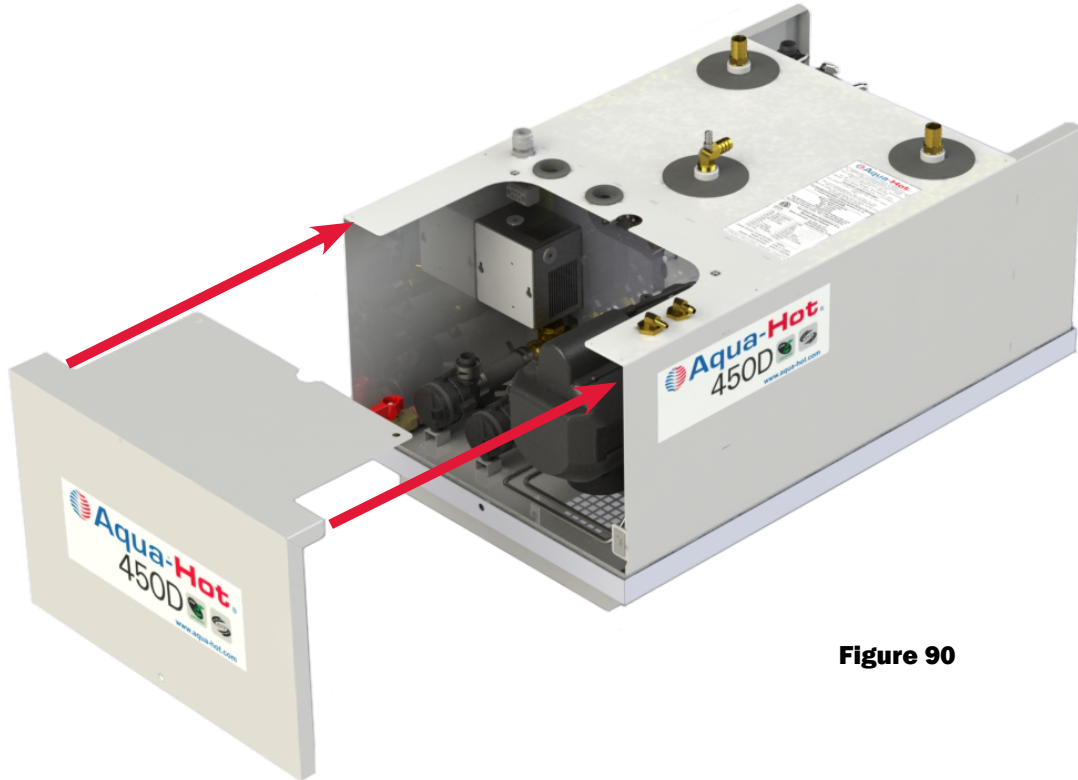

Figure 89

NOTE: The diesel burner's Controller might have to be mounted onto the side of the burner before the plugs are inserted into the Controller, otherwise it might not be possible to mount the Controller.

Step 4: Reinstall the Access Cover

Reinstall the Aqua-Hot's access cover and securely tighten the three bolts securing the access cover in place.

**Figure 90**

NOTE: The access cover must be installed prior to operation as a safety switch (interlock) exists. It will prevent the Aqua-Hot from operating whenever the access cover is not properly installed.

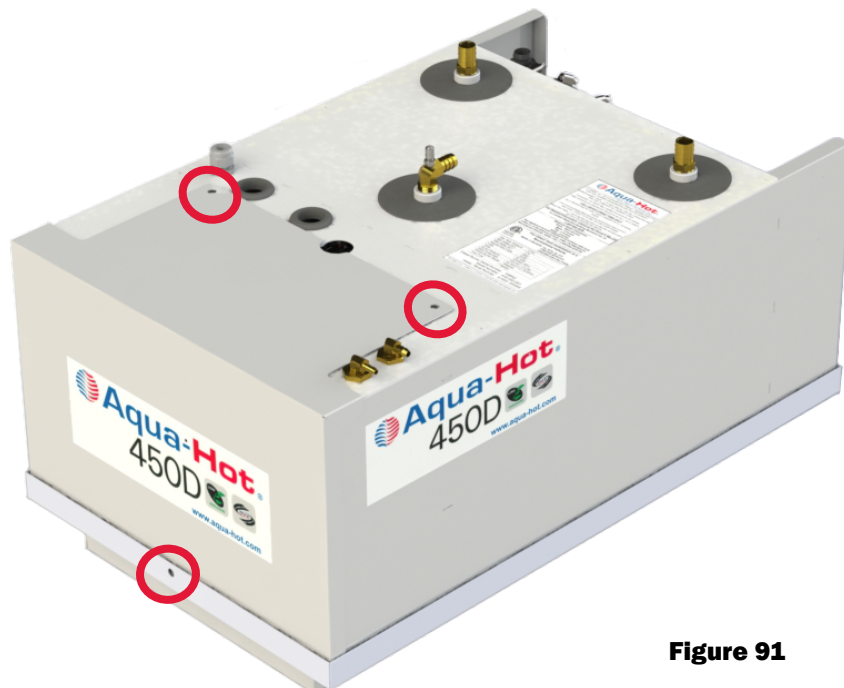
**Figure 91**

Diesel Burner Motor

The diesel burner motor drives the combustion air blower and the fuel pump. In order to perform the following procedures, it may be necessary to detach the diesel burner head.

NOTE: The Aqua-Hot 400 Series is equipped with a 20A Fast Blow Fuse, located on the #20 wire, between the Reporter and diesel burner controller's B-plug, which is the diesel burner's motor power wire.

Troubleshooting Procedure:

1. Locate the diesel burner controller's C-plug and insert the probes of a DC voltmeter into the C-2 (+) and the C-5 (-) locations.

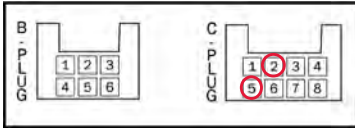

Figure 92

- Turn the burner switch ON and verify the burner status and heating status are showing ON, on the Reporter.
- Observe the voltage level. If a normal voltage range registers on the voltmeter and the motor is not operating, inspect the C-plug harness for any loose or damaged wire connections. If the C-plug harness and connections are in good condition and the motor is not in operation, the motor must be replaced.

If there is not 12V DC present on the C-2 pin, continue with the troubleshooting procedure.

NOTE: The motor may have a flat spot and will cause the burner to work intermittently. When testing the motor, be sure to test it multiple times to find the intermittent problem.

2. Verify the Reporter is sending power to the diesel burner motor.

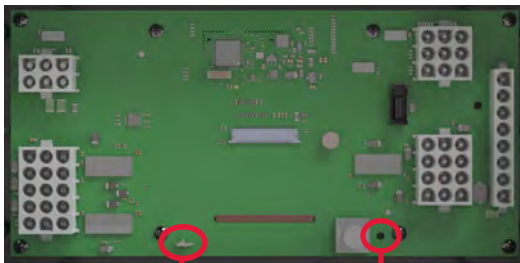

Figure 93
Burner Power (+)
Board Power (Battery Positive)

- Using a voltmeter, check for 12V DC on the burner power pin. If no power, verify the Reporter is receiving power from the batteries.

Diesel Burner Controller

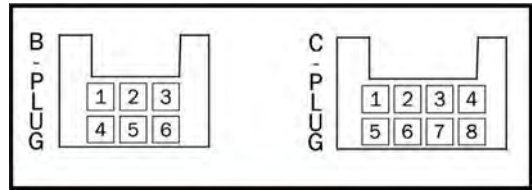

Figure 94

- Using a voltmeter, check for 12V DC on the back of the Reporter (wire #20). If no power is present, verify the Reporter is receiving power and there are no faults showing.
- If the Reporter does not have 12V DC power at the Board Power pin, the Reporter will have to be replaced.

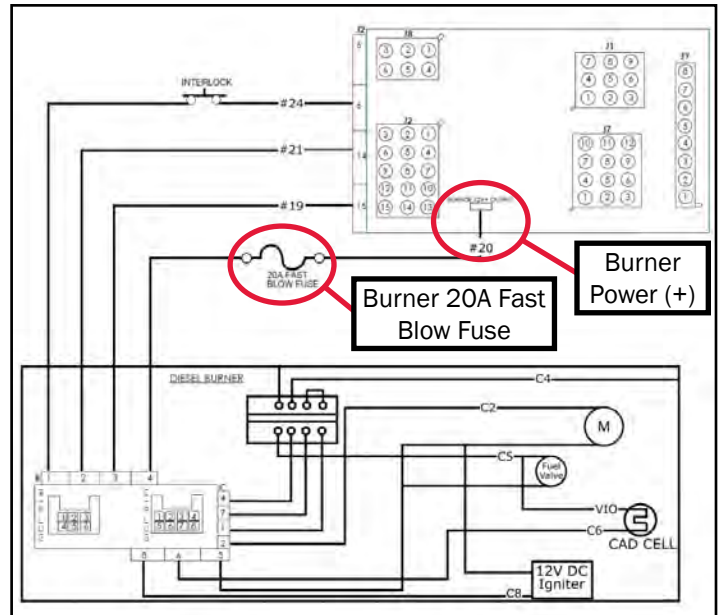

Figure 95

RPM Test:

1. Disconnect the ignition cables from the ignition electrodes.
2. Remove the four ignition coil screws that secure the ignition coil to the protection cap.
3. Lift the ignition coil and disconnect its wires from the C-plug harness prior to removing completely.
4. Remove the protection cap from the diesel burner so that the motor and clutch halves are exposed.

NOTE: It may be necessary to remove the diesel burner to remove the bottom two screws securing the protection cap in place. Follow the directions on detaching and reattaching the diesel burner starting on Page 44.

5. Place a few wraps of black electrical tape around the clutch halves, and then place a small piece of reflective tape over the black tape.
6. Disconnect the motor's black (+) and brown (-) wires from the C-plug harness' black (+) and brown (-) wires.
7. Connect the motor's wires directly to a 12V DC power supply.
8. Turn the power supply ON and use a photo-tachometer to test for a proper RPM reading.
9. At approximately 12V DC, the RPM reading should be 4500 RPM's (± 300 RPM). If the motor's RPM reading is not within these specifications, the motor must be replaced.

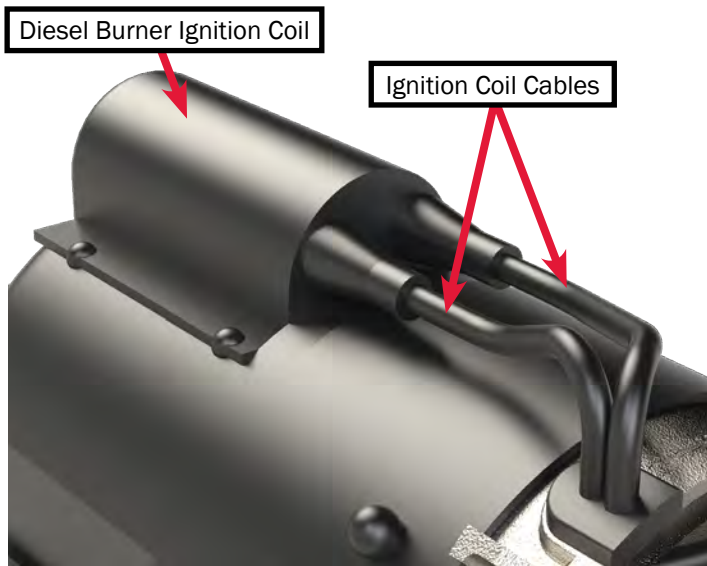

Figure 97

NOTE: Test the diesel burner's bearings prior to reattaching the diesel burner head or replacing the motor. Worn bearings can cause lower than normal RPM readings and premature motor wear. To properly test for worn bearings, reference the bearings function test section.



Figure 96

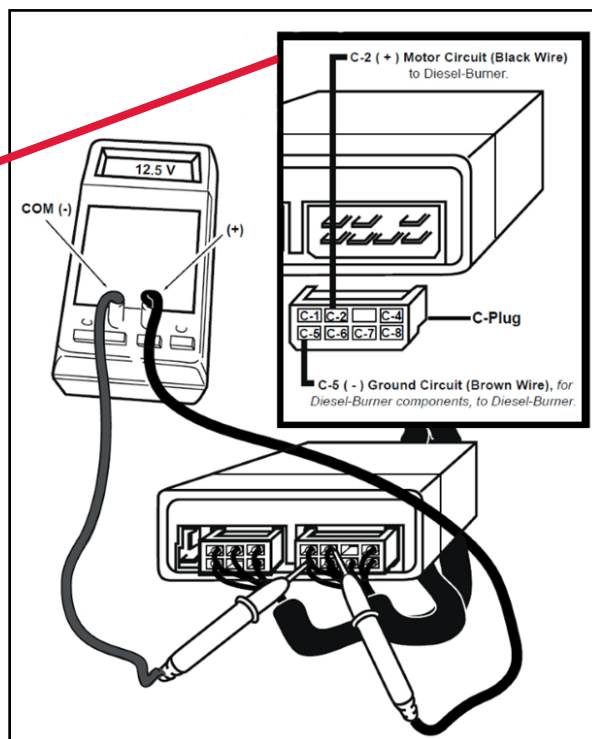

Figure 98

Motor Replacement Procedure:

1. Follow the directions on Page 44 for detaching the diesel burner.
2. Remove the four ignition coil screws that secure the ignition coil to the protection cap. Lift the ignition coil to disconnect its wires from the C-plug harness prior to removing. Remove the protection cap from the diesel burner so that the motor clutch halves are exposed.
3. Remove the three Hex-Head screws that secure the motor and flange assembly to the blower housing. Remove the motor and flange assembly along with the clutch halves. Disconnect the motor's black (+) and brown (-) wires from the C-plug harness' wires.
4. Detach the motor from the motor flange by removing the two Philips heads screws that fasten the two parts together.
5. The motor must be mounted to the flange with the wires and drain hole pointing downward, and the recessed edge of the motor flange pointing upward. This will ensure a proper protection cap fit.
6. Reinstall a clutch half on both the new motor's shaft and the combustion air blower shaft. Attach the motor and flange assembly, with the recessed edge of the motor flange in-line with the wiring access slot of the blower casing to the blower housing with the three Hex-Head screws.
7. Connect the black (+) and the brown (-) wires of the new motor to the C-plug harness pin 8 (+) and pin 5 (-). Feed the C-plug harness' wires back through the wiring access hole in the protection cap.
8. Reinstall the protection cap. Reconnect the motor's wires (\pm).
9. Reinstall the ignition coil and secure to the protection cap with the four ignition coil screws.
10. Follow the directions for reattaching the diesel burner on Page 47.
11. Test for proper operation.

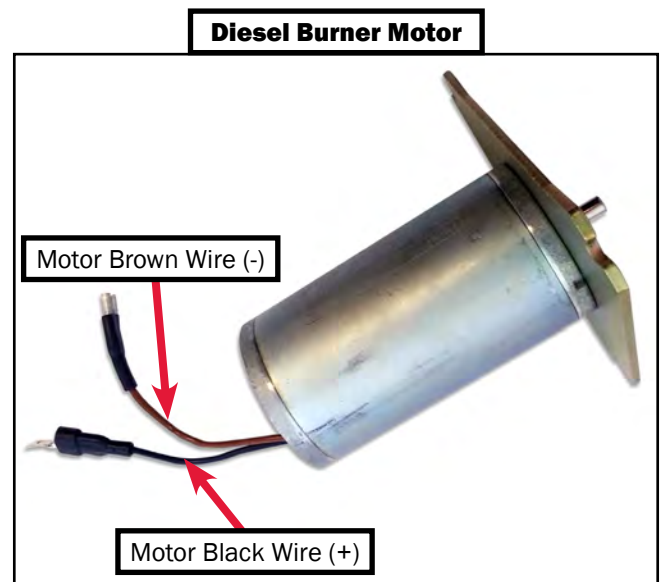
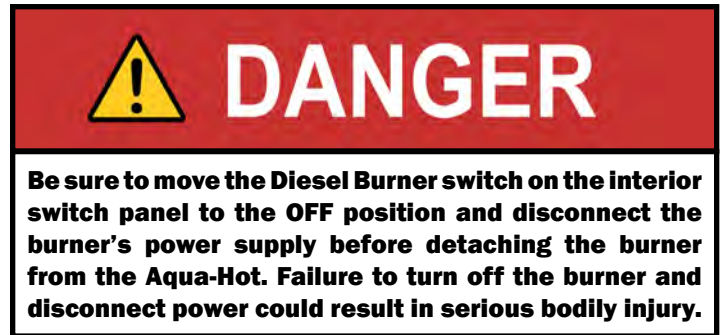

Figure 99

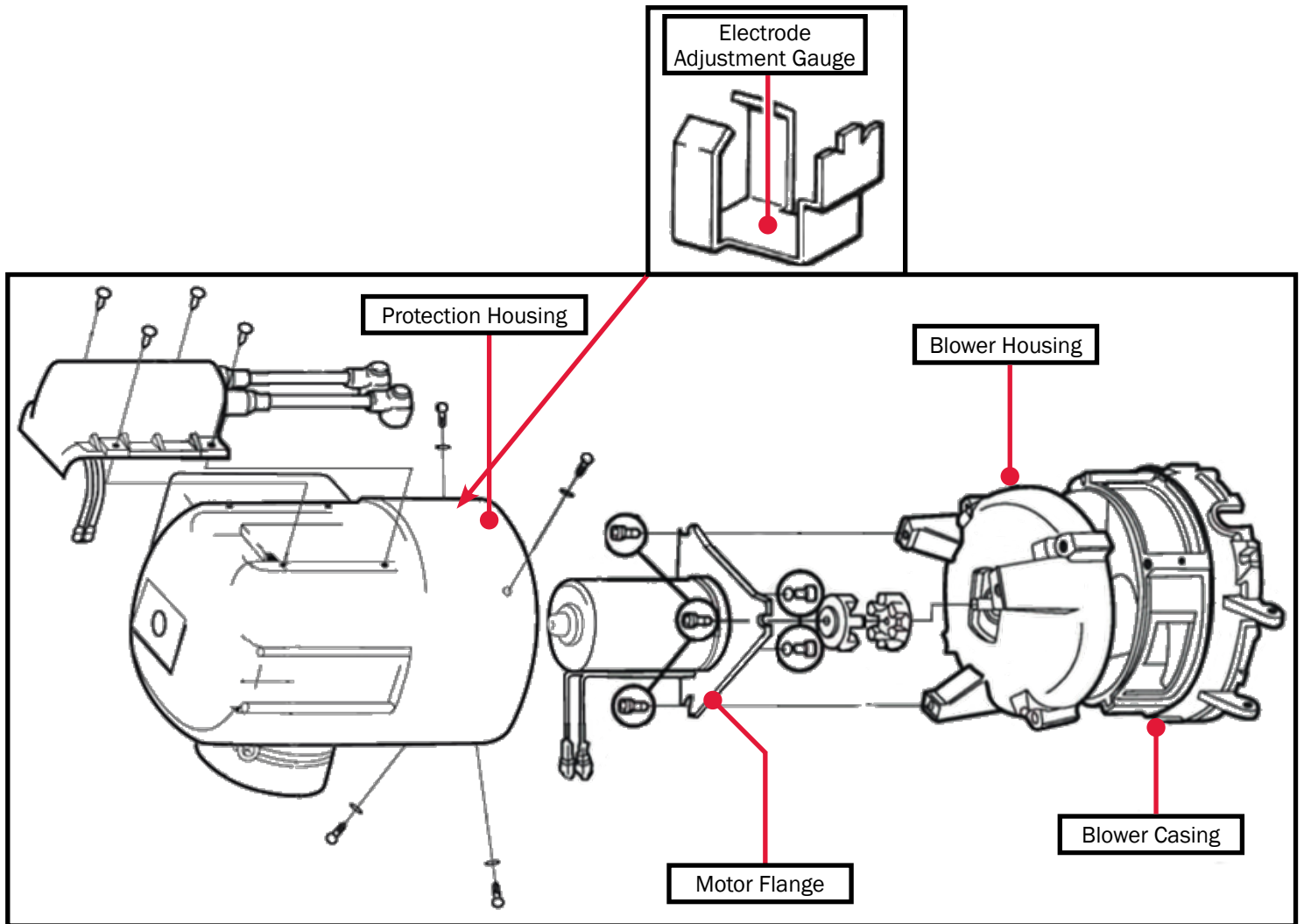

Figure 100

Flame Sensor

The flame sensor is a photo resistive device which supplies the diesel burner's controller with a DC voltage signal when it detects a flame. When the flame sensor senses the light of the flame, it will shut the ignition coil off, and send a signal to the Controller indicating that everything is working properly. If the flame sensor does not sense the flame, it will shut the diesel burner down in a default after 20 seconds.

NOTE: In order to perform the following procedures, it is necessary to detach and reattach the diesel burner head. Be sure to review the detaching/reattaching procedure starting on Page 44.

Component Test: Ohms

1. Detach the diesel burner.
2. Once the diesel burner has been removed, locate and detach the flame sensor's green and blue wires from the C-plug harness wires.

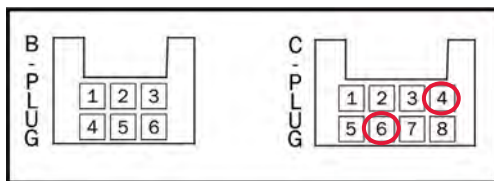

Figure 101

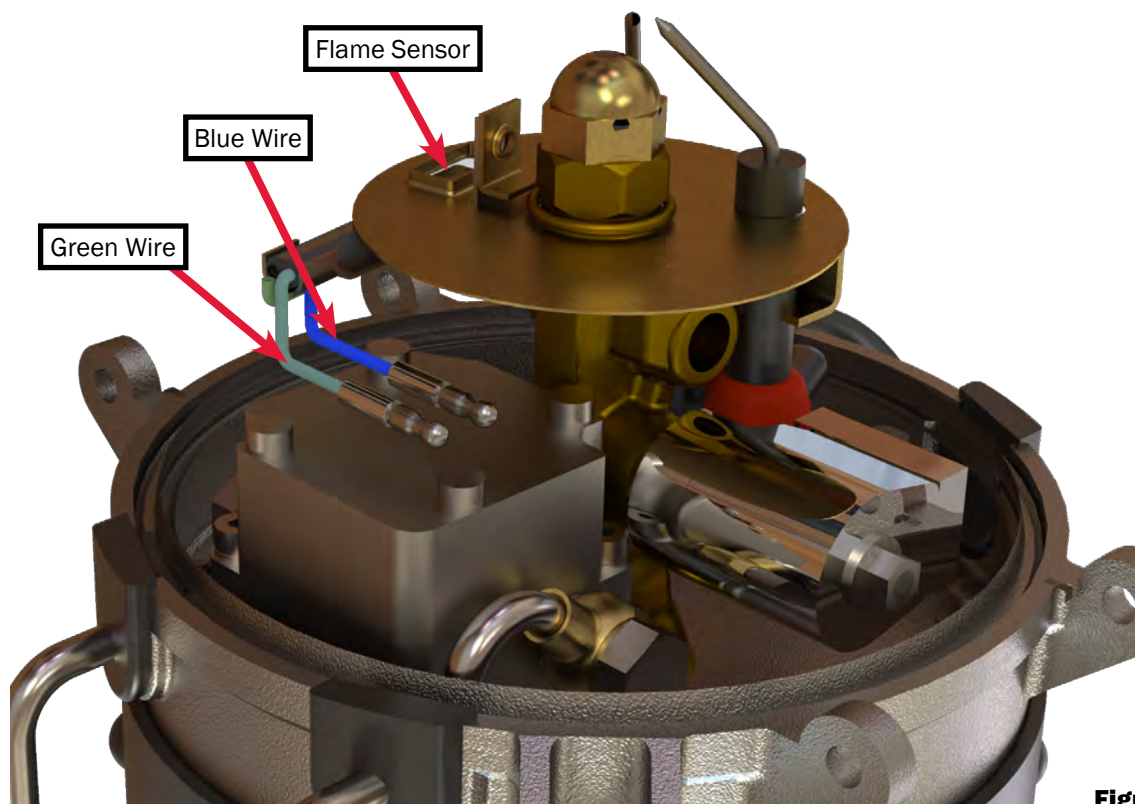

Figure 102

3. Connect the flame sensor's green and blue wires to an ohmmeter.
4. Check resistance by placing a shop rag over the flame sensor's glass surface, to simulate a no-flame condition. Remove the rag and expose to a light source to simulate a flame condition.
5. If the flame sensor is operating properly, the ohmmeter should register high resistance, over 300K Ω when the glass surface is covered, and less than 200 Ω when exposed to a light source.
6. If these resistance numbers cannot be obtained, verify the flame sensor's glass sensor is clean. If the flame sensor is clean and the resistance numbers cannot be obtained, the flame sensor must be replaced.

NOTE: Some flame sensors are intermittent and will need to be tested numerously. If the flame sensor tests well, and it still will not operate, it is possible there is an issue with the Reporter.

Flame Sensor Maintenance:

1. For light dirt, dust, and/or carbon deposits, simply wipe off the flame sensor with a soft cloth.
2. Should heavy carbon deposits be present, completely remove the flame sensor from the photo disc and clean with brake cleaner.

Flame Sensor Replacement:

1. In order to perform the following procedures, it is necessary to detach the diesel burner head. Be sure to review the detaching/reattaching instructions starting on Page 44.
2. Remove the screw that fastens the flame sensor to the photo disc (as shown in Figure 104), and detach the flame sensor's green and blue wires from the C-plug harness' green and violet wires. Remove the defective flame sensor.
3. Slide the tab of the new flame sensor into the provided slot in the photo disc and secure in place with the screw.
4. Connect the flame sensor's green wire to the green C-plug harness wire (pin 6), and connect the blue wire to the C-plug harness' violet wire (pin 4).
5. Follow the instructions for reattaching the diesel burner head on Page 47.

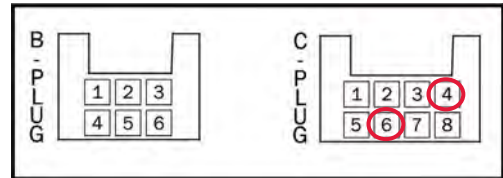

Figure 103

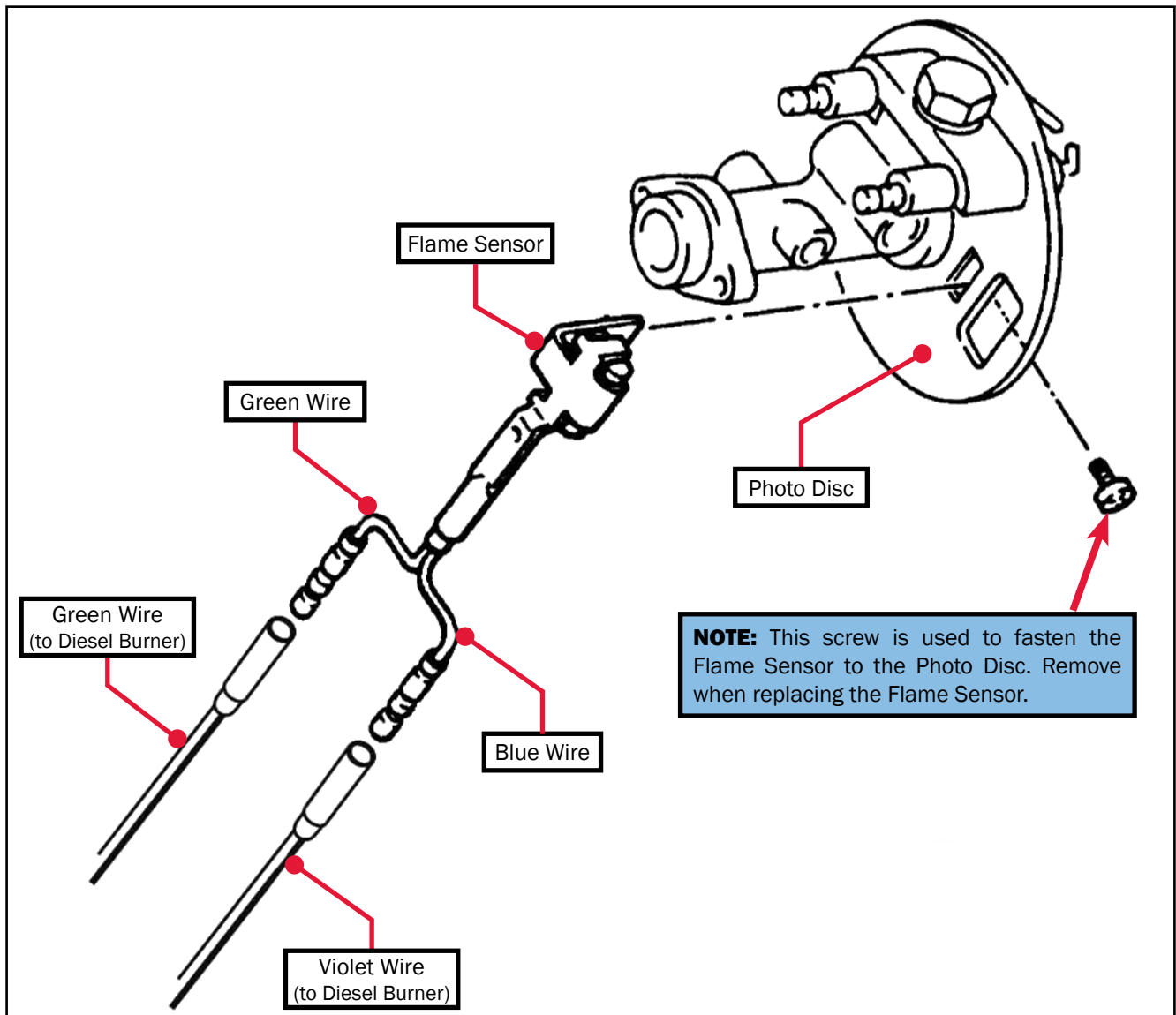

Figure 104

Ignition Electrodes

The diesel burner's ignition coil produces a high voltage ignition spark (approximately 8000 volts) across the ignition electrodes, which ignites the incoming air/fuel mixture.

NOTE: In order to perform the following procedures, it is necessary to detach and reattach the diesel burner head. Be sure to review the detaching/reattaching procedure starting on Page 44.

Cleaning & Maintenance:

1. Polish away any carbon deposits that may have baked onto the metal tips of the ignition electrodes with a coarse sponge.
2. If the ignition electrode's electrical insulator is cracked or damaged, the ignition electrode must be replaced.

Ignition Electrode Adjustment Procedure:

1. Follow the directions for detaching/reattaching the diesel burner on Page 44.
2. Using a 10mm socket, lightly loosen the retaining clamp bolt.
3. Place the electrode adjustment gauge on the fuel nozzle manifold hex making sure the gauge is pushed all the way down until it rests on the tip of the nozzle. Insert the metal tips of the ignition electrodes into the appropriate notches of the electrode adjustment gauge.
4. Using a 10mm socket, tighten the retaining clamp bolt.
5. Remove the electrode adjustment gauge and reattach to the diesel burner head.

NOTE: The electrode gauge is mounted to the side of the burner cap. The gauge goes on the fuel nozzle and the tips of the electrodes should be perfectly lined up in the notches.

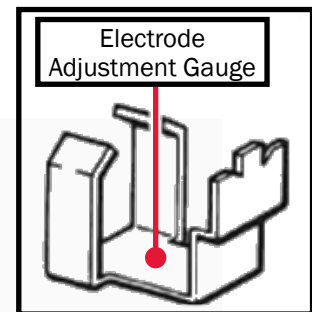
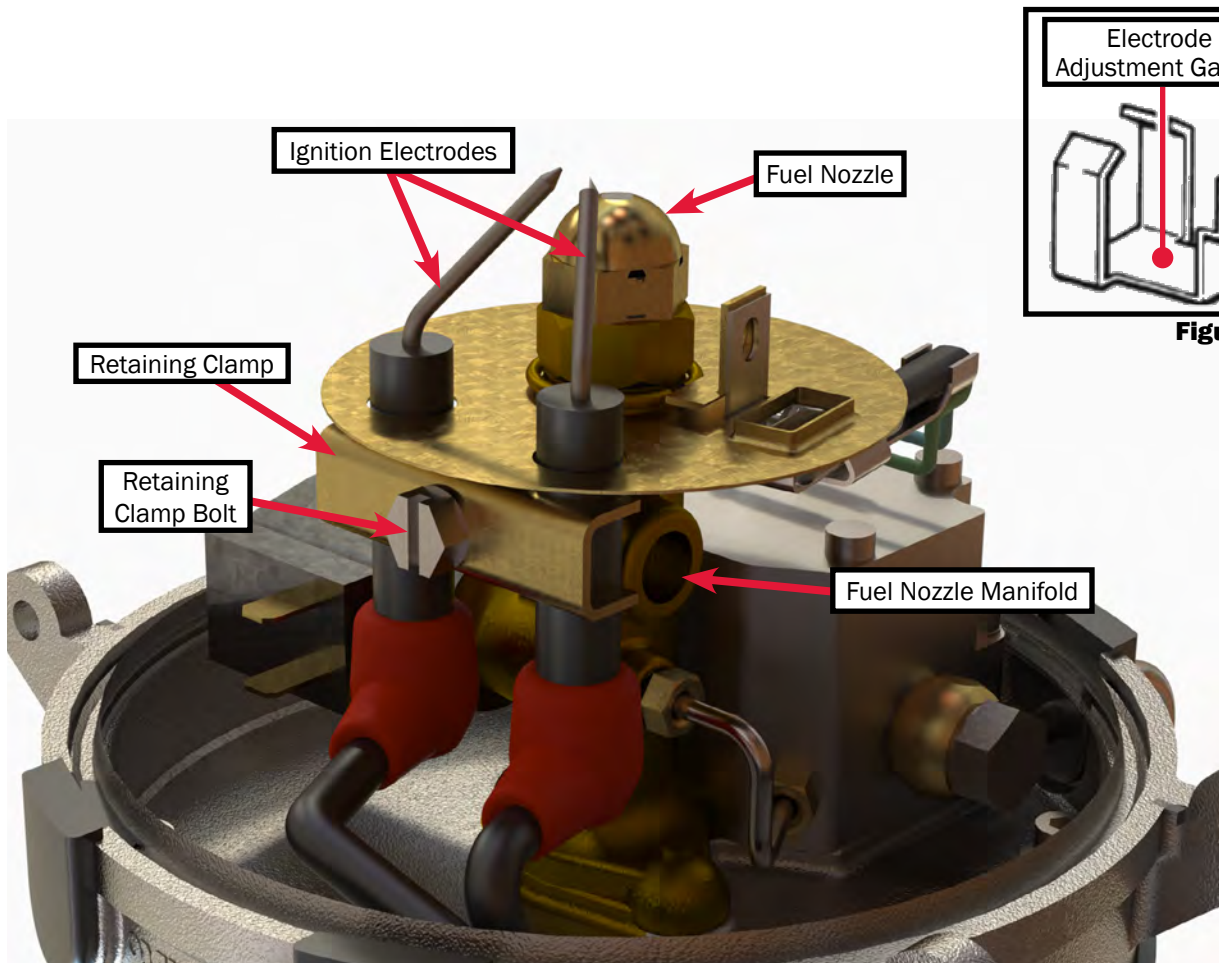

Figure 105

Figure 106

Replacement Procedure:

1. Using a 10mm socket, loosen and remove the retaining clamp bolt and the retaining clamp.
2. Slide the electrode out of the photo disc.
3. To remove the electrode, hold onto the orange electrode boot, and pull firmly on the electrode.
4. Once the electrode has been removed inspect inside the orange electrode boot for the retaining clip, which holds the electrode in place. If it is missing, replace the electrode boot.
5. Insert the new electrode into the orange electrode boot, and snap into place. Pull firmly on the electrode to make sure the retaining clip has secured the electrode in place.
6. Slide the electrode into the photo disc.
7. Install retaining clamp and retaining clamp bolt and finger tighten.
8. Follow the ignition electrode adjustment procedure to properly adjust the electrodes.

NOTE: Be sure not to over-tighten the retaining clamp bolt when readjusting the ignition electrodes. Over-tightening the retaining clamp bolt will bend the retaining clamp and prevent the photo disc from floating freely. Not allowing the photo disc to float freely will cause poor combustion and result in a smoky exhaust. A bent retaining clamp can be re-straightened with a punch and hammer. Lay the clamp's beveled side down on a solid flat surface and align the thick end of the punch at dead center. Tap the punch lightly until the retaining clamp returns to proper form.

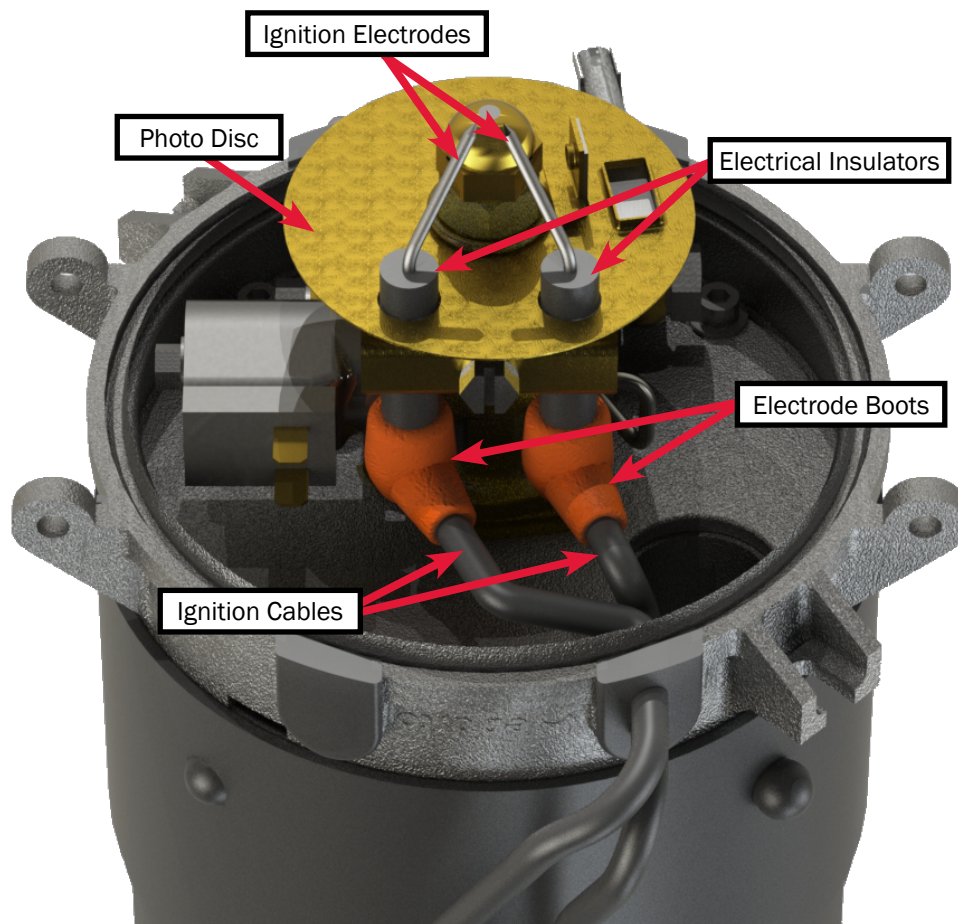

Figure 107

Ignition Coil

The diesel burner's ignition coil produces a high voltage ignition spark (approximately 8000 volts), which is released across the metal tips on the ignition electrodes during the initial diesel burner start up.

Use extreme care when testing the ignition coil, as a High Voltage Shock may result.

NOTE: In order to perform the following procedures, it is necessary to detach and reattach the diesel burner head. Be sure to review the detaching/reattaching procedure starting on Page 44.

Component Test:

1. Remove the four ignition coil screws that secure the ignition coil in place.
2. Disconnect the ignition coil's black (+) and brown (-) wires from the C-plug harness' yellow (+) and brown (-) wires.
3. Connect the ignition coil wires directly to a 12V DC power supply (black + wire to + lead and brown - wire to - lead).
4. Turn the power supply ON and watch for a spark to appear across the metal tips of the ignition electrodes. If a spark does not appear, the ignition coil must be replaced.

NOTE: Some ignition coils are intermittent and will need to be tested numerously. If the ignition coil tests well, and it still will not operate, it is possible there is an issue with the Reporter.



CAUTION

Before replacing the ignition coil, verify the electrodes are not cracked or broken, and they are adjusted properly. Ensure the electrode boots are securely holding the electrodes in place and that they are not broken inside the ignition coil wires.

Replacement Procedure:

1. Disconnect the ignition cables from the ignition electrodes. Remove the four ignition coil screws that secure the ignition coil to the protection cap. Lift the ignition coil and disconnect its wires from the C-plug harness wires, prior to removing.
2. Connect the new ignition coil's black (+) and brown (-) wires to the C-plug harness' yellow (+) and brown (-) wires. Attach the ignition coil to the protection cap with the four ignition coil screws, then reconnect the ignition cables to the ignition electrodes.
3. Follow the instructions for reattaching the diesel burner and test for proper operation.

NOTE: If the new ignition coil does not function, check wire connections and ensure they are properly connected and the electrodes are properly adjusted.

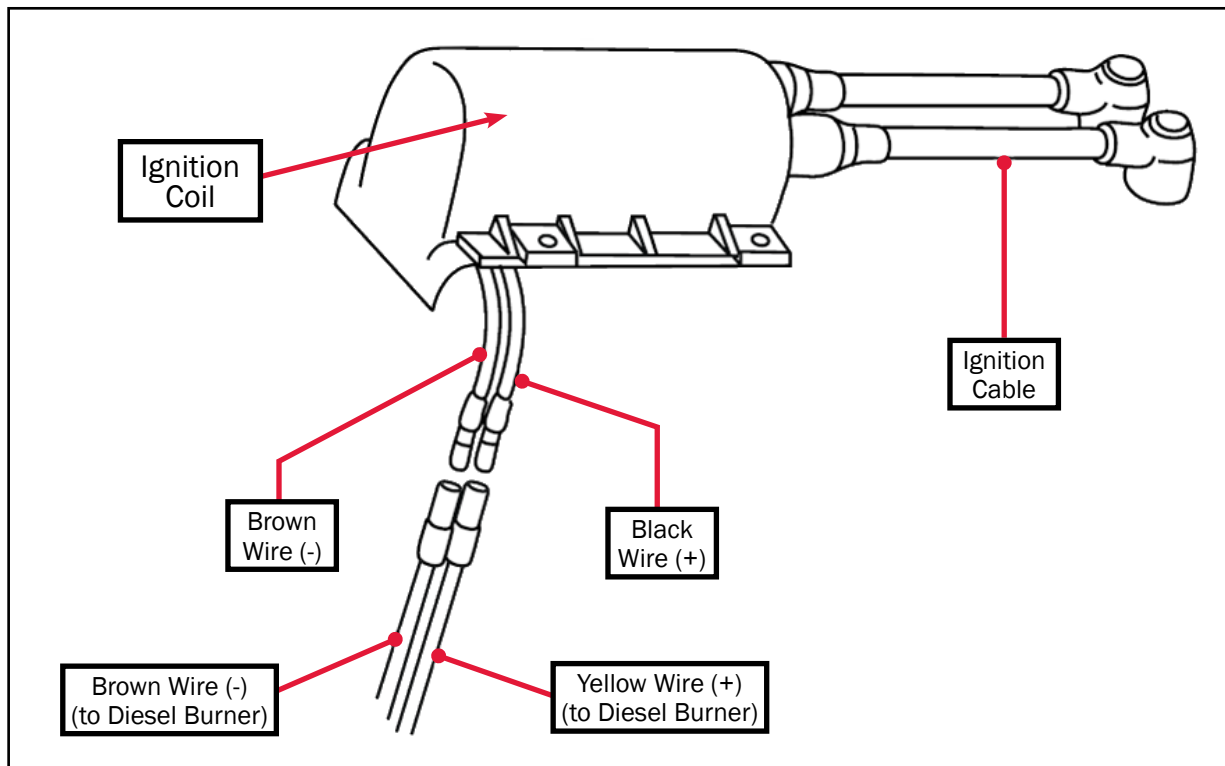

Figure 108

Fuel Nozzle

The fuel nozzle is simply a fuel atomizer. It reduces the diesel fuel into a fine spray which is mixed with incoming combustion air, and is ignited within the combustion chamber.

Fuel Nozzle Component Test:

NOTE: In order to perform the following procedures, it is necessary to detach and reattach the diesel burner head. Be sure to review the detaching/reattaching procedure starting on Page 44.

1. Detach the diesel burner.
2. Hook the diesel burner up to an alternate fuel source.
 - Disconnect the steel fuel lines from the diesel burner.
 - Install the fuel line bypass adapter fitting onto the diesel burner.
 - Install rubber fuel lines on both the supply and return fuel pipes, and install the other end of the rubber fuel lines into an adequate supply of diesel fuel. Reference Figure 109.
3. Remove both the ignition cables from the ignition electrodes, or connect a jumper wire (with alligator clips) across the metal tips of the electrodes.
4. Remove the B-plug from the diesel burner's controller.
5. Turn the diesel switch ON (on the interior switch panel), and plug the B-plug back into the diesel burner's controller to activate the diesel burner. After approximately 20 seconds, the fuel solenoid will "click" and a fine mist of fuel should appear from the fuel nozzle in a cone-shaped spray pattern.
6. Remove the B-plug from the diesel burner controller.
7. If the cone-shaped spray pattern did not appear, follow the troubleshooting guides for the following components, and verify they are operating properly:
 - Fuel Solenoid
 - Fuel Pump
 - DC High-Limit Thermostats
8. If the components listed above are operating properly, and there is still no fuel coming out of the nozzle, replace the fuel nozzle.



Figure 109



DANGER

Be sure to reattach the diesel burner head prior to switching the heater ON. Failure to do so may result in ignition of the diesel burner and serious bodily injury.

NOTE: Be sure to use care when handling the new fuel nozzle. Oils and/or small dust or dirt particles from your hands may plug the nozzle's small orifice. A partially plugged orifice will restrict fuel flow, which will affect the combustion process of the diesel burner.

Fuel Nozzle Cleaning and Maintenance:

The fuel nozzle is a precision calibrated part and **cannot** be cleaned or serviced. A replacement of the fuel nozzle is recommended annually.

Fuel Nozzle Replacement Procedure:

1. Use a $\frac{3}{4}$ " wrench to hold the fuel nozzle stand hex while loosening the fuel nozzle with a $\frac{5}{8}$ " wrench and remove as shown in Figure 110.
2. When replacing the fuel nozzle, be sure to tighten the nozzle, loosen it a $\frac{1}{4}$ turn, and then firmly re-tighten. This will establish a seated fit and avoid any leaks.

3. After replacing the fuel nozzle, reattach the diesel burner head.
4. Turn ON the diesel switch for 5 seconds, then turn it OFF. This will activate the diesel burner's prime-cycle and flush the fuel system of any potential contaminants. Perform this procedure twice.
5. Test for normal operation.

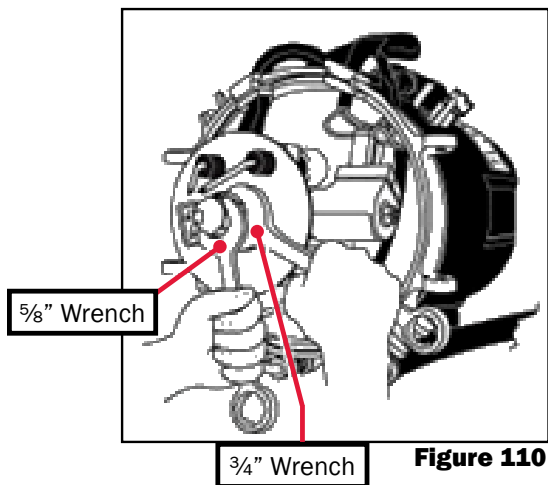

Fuel Nozzle **Figure 111**

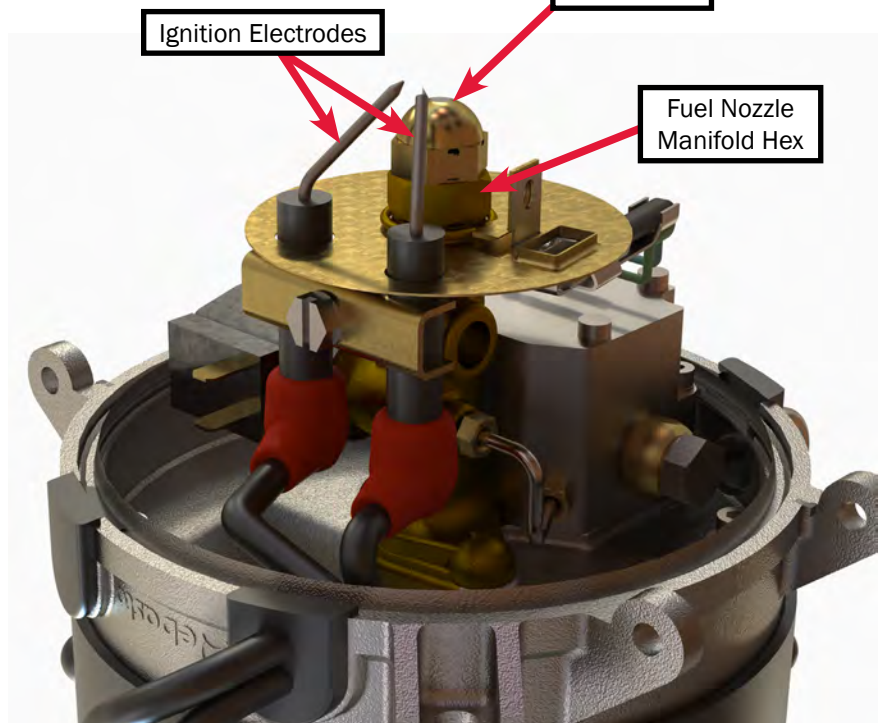

Figure 112

Fuel Solenoid

The fuel solenoid allows the flow of diesel fuel to the diesel burner's fuel nozzle.

NOTE: If a long after-smoking condition exists during the diesel burner's purge cycle, the fuel solenoid valve kit may need to be replaced.

Fuel Solenoid Component Test:

1. Locate and detach the C-plug harness' violet (+) and brown (-) wires from the fuel solenoid.
2. Connect the (-) lead of a 12V DC power supply to the fuel solenoid's (-) electrical terminal.
3. Intermittently apply the (+) lead of the power supply to the fuel solenoid's (+) electrical terminal.
4. Listen for the fuel solenoid to click (open and close).
5. If the fuel solenoid does not click, it must be replaced.

NOTE: If the fuel solenoid is not working, troubleshoot the diesel burner's high-limit thermostats (2). If they are tripped, they will not allow the fuel solenoid to operate.

Fuel Solenoid Replacement Procedure:

1. Disconnect the C-plug harness' violet (+) and brown (-) wires from the fuel solenoid.
2. Using a 8mm wrench, remove the lock nut and flat washer from the end of the fuel solenoid shaft and then pull the fuel solenoid away from the nozzle stand approximately 1/2". Remove the fuel solenoid shaft from the nozzle manifold using a 16mm wrench. Discard the shaft and valve kit, as replacements are provided with the new fuel solenoid assembly.
3. Insert the contents of the new fuel solenoid valve kit into the new fuel solenoid shaft. Slide the new fuel solenoid onto the fuel solenoid shaft. Thread the new fuel solenoid shaft with the fuel solenoid to the fuel nozzle manifold and tighten. Secure the fuel solenoid in place with the new flat washer and lock nut.
4. Connect the C-plug harness' (+) and brown (-) wires to the fuel solenoid's (+) and (-) electrical terminals.
5. Test for normal operation.

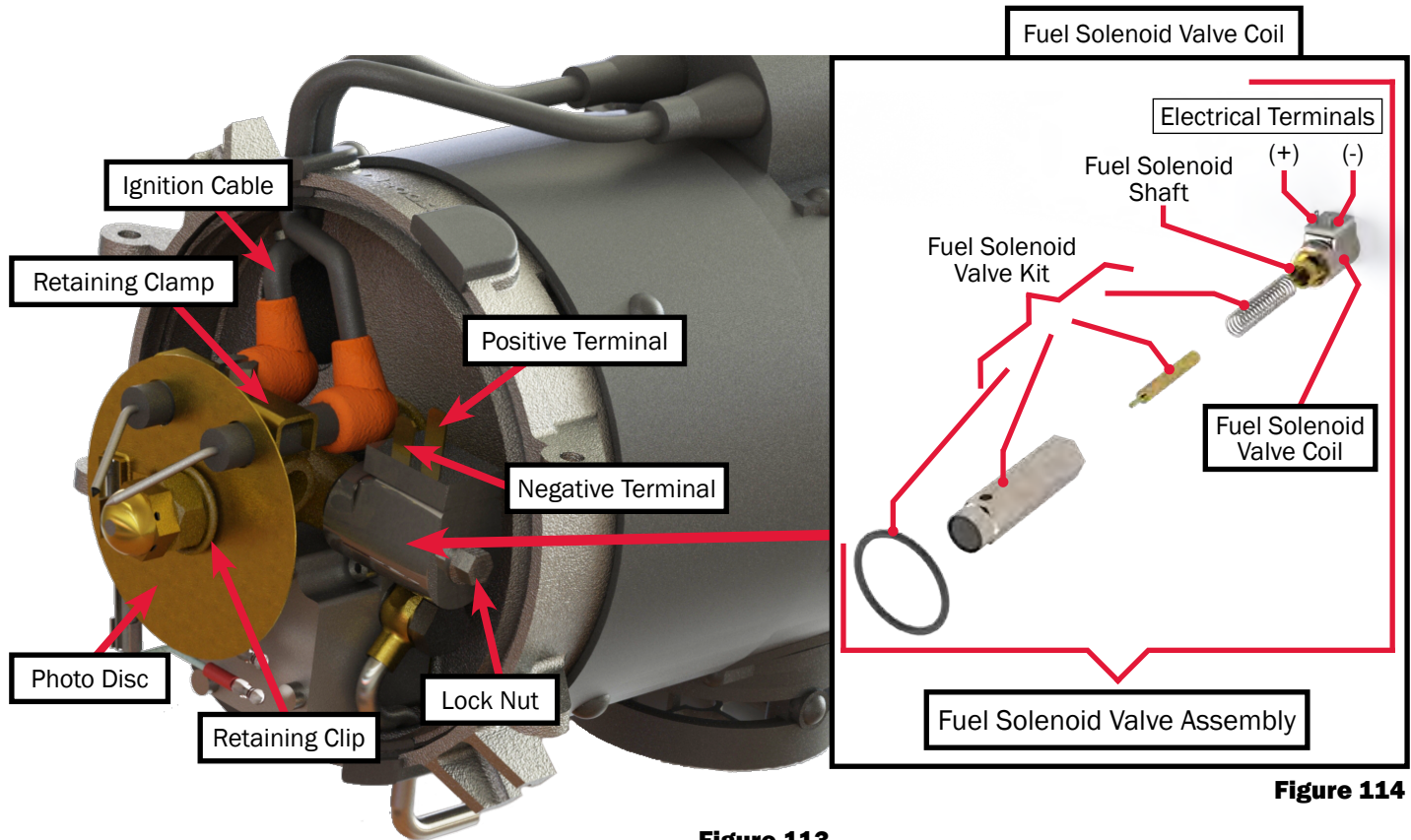

Figure 113

Figure 114

Fuel Pump

The fuel pump draws diesel fuel from the vehicle's fuel tank and creates a preset pressure of 145 PSI, which is required for proper fuel atomization. Reference the illustration below for a basic overview and understanding of how the fuel pump functions.

Fuel Pump Cleaning and Maintenance:

1. Check all fuel connections for tightness.
2. Check the screen filter located in the fuel supply inlet of the fuel pump for dirt particles. Clean and/or replace if necessary.
3. To adjust the fuel pressure, refer to Page 77 - Fuel pressure check and adjustment.



Fuel Pump Testing Procedure:

1. Clamp off and remove the fuel return and fuel supply lines coming into the Aqua-Hot unit.
2. Attach a short piece of fuel line to both the fuel return and fuel supply ports.
3. Submerge the opposite end of the temporary fuel supply line in a container of diesel fuel.
4. Place the opposite end of the temporary fuel return line in an empty container.
5. Turn the diesel switch ON to activate the diesel burner, and wait ten seconds.

6. If fuel does not flow out of the return line into the empty container, the fuel pump must be replaced,
7. If fuel does flow through the fuel pump when ran off an external source, inspect the following in the coach:

NOTE: Prior to replacing the fuel pump, be sure to inspect the screen filter in the supply inlet of the fuel pump for dirt particles. Clean and/or replace if necessary. A plugged screen filter will restrict fuel from entering the fuel pump.

- Check the motor home fuel tank for diesel fuel. If the fuel level is below ¼, the Aqua-Hot diesel burner will not operate.
- Inspect the supply fuel line for any kinks, which would prohibit fuel flow.
- Inspect the supply fuel line for cuts, which would cause the diesel burner to suck air.
- Inspect the fuel filter to make sure all fittings are tight, including hose clamps. Make sure the fuel filter is tight.
- Inspect the Aqua-Hot for loose or cracked fittings.
- Inspect the supply fuel system for loose hose clamps.
- Inspect the fuel pick-up tube in the tank for any loose connections and/or pin holes in the tube.

Fuel Pump Replacement Procedure:

NOTE: In order to perform the following procedures, it is necessary to detach and reattach the diesel burner head. Be sure to review the detaching/reattaching procedure starting on Page 44.

1. Locate and disconnect the C-plug harness wires that connect to the flame sensor and the fuel solenoid. Also, disconnect the ignition cables from the ignition electrodes.
2. Remove the retaining clip that secures the photo disc in

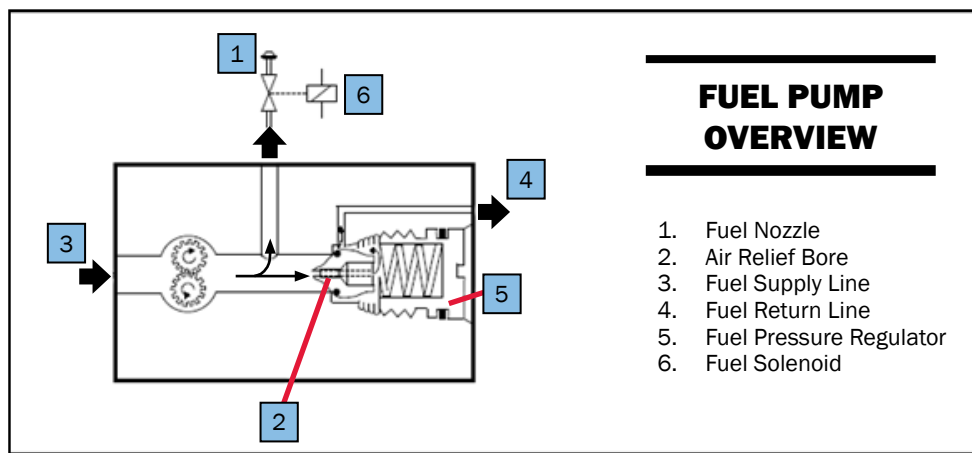

Figure 115

place. Gently lift the photo disc so that it releases from the nozzle stand and the ignition electrodes.

3. Loosen the supply and return banjo bolts to remove the fuel supply and return pipes from the fuel pump. Disconnect the high pressure fuel pipe from both the fuel pump and the nozzle stand. Discard the high pressure fuel pipe, gasket rings, and banjo bolts, as replacements are provided in the new fuel pump kit.
4. Remove the four nozzle stand plate screws that secure the nozzle stand plate in place. Remove the nozzle stand plate by pulling on the nozzle stand until the plate releases from the cast-aluminum blower casing.
5. Remove the two pump mounting screws that secure the fuel pump in place. Turn the nozzle stand plate over and remove the snap ring from the fuel pump shaft, using snap ring pliers. Remove the nylon drive gear and then the fuel pump.
6. Attach the new fuel pump to the nozzle stand plate with the two pump mounting screws. Turn the nozzle stand plate over to install the nylon drive gear on the fuel pump's shaft and secure in place with the snap ring. Dab the teeth of the nylon drive gear with white lithium grease (IsoFlex LDS-18 is recommended).
7. Fit the nozzle stand plate inside the cast-aluminum blower casing and secure in place with the four nozzle stand plate screws. Install the grommets on the fuel return and supply banjo pipes and secure the pipes to the fuel pump with the new banjo bolts and gasket rings.

NOTE: Do not adjust the fuel pressure regulator of the new fuel pump, as it has been factory preset.



CAUTION

Inspect the nylon drive gear's cavity inside the cast-aluminum blower casing for fuel stains. If fuel stains are present, a replacement of the bearings and/or the entire blower casing may be necessary. Leaking fuel could cause bearing seizure, resulting in potential damage to the internal bore/bearing of the blower casing

8. Reconnect the C-plug harness' violet (+) and brown (-) wires to the fuel solenoid's (+) and (-) electrical terminals.
9. Insert both the ignition cables into the rubber grommet and slide into the appropriate notch on the blower casing.
10. Reconnect the ignition cables to the ignition electrodes.

NOTE: Failure to use the new gasket rings or the correct order placement could result in a fuel leak.

11. Reinstall the photo disc and secure it in place with the retaining clip.
12. Reconnect the flame sensor's green wire to the green C-plug harness and the blue wire to the C-plug harness' violet wire. Install rubber grommets around the harness wires, and set into place.
13. Follow the directions for reattaching the diesel burner on Page 47.
14. Test for normal operation.

NOTE: Check the ignition electrodes for proper adjustment prior to reattaching the diesel burner.

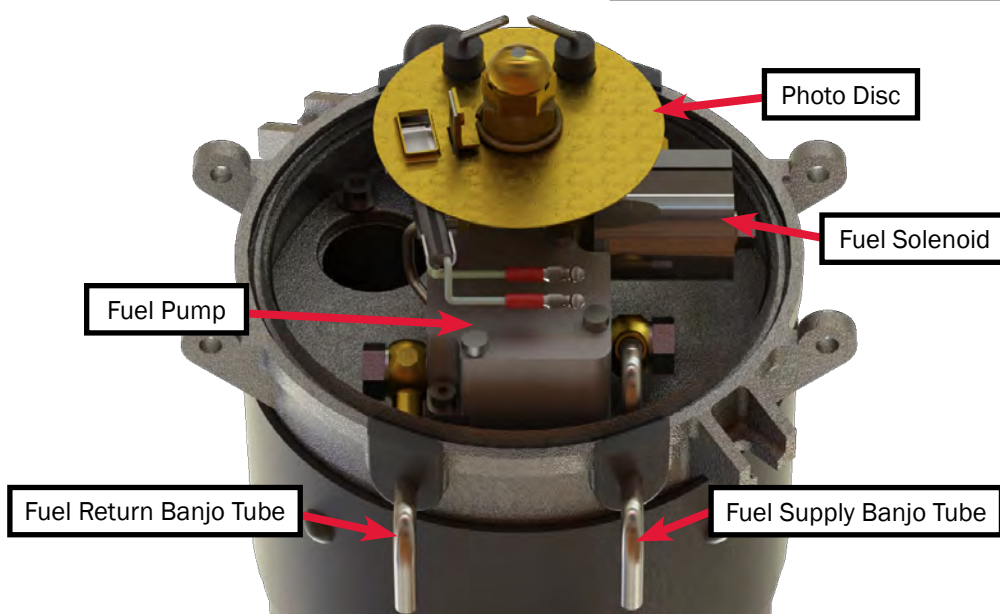

Figure 116

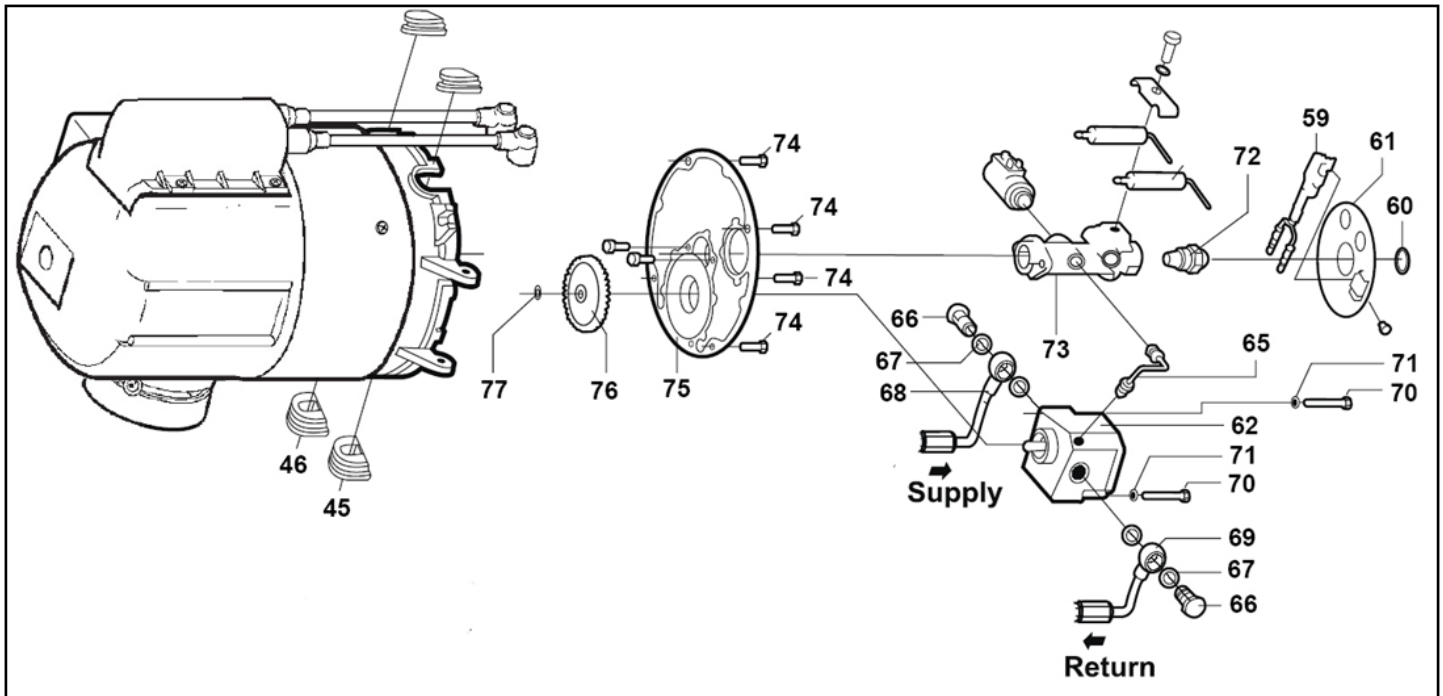

Figure 117

Key	Description
45	Grommet, Blower Casing, Left
46	Grommet, Blower Casing, Right
59	Flame Sensor
60	Retaining Clip, Photo Disc
61	Photo Disc
62	Fuel Pump
65	High Pressure Fuel Tube
66	Banjo Bolt
67	Gasket Ring, Copper
68	Banjo Fuel Tube, Supply
69	Banjo Fuel Tube, Return
70	Mounting Screw, Fuel Pump
71	Washer, Lock, Fuel Pump
72	Fuel Nozzle, 0.35 GPH
73	Fuel Nozzle Manifold, Brass
74	Manifold Plate Screw
75	Manifold Plate
76	Fuel Pump Nylon Gear
77	Snap Ring

Bearings

The bearings support the combustion air blower's shaft and allows the blower to turn smoothly.

Bearings Test:

1. In order to perform the following procedure, it is necessary to detach and reattach the diesel burner head. Be sure to review the detaching and reattaching section for detaching and reattaching instructions starting on Page 44.
2. Locate and disconnect the C-plug harness wires that connect to the flame sensor and fuel solenoid. Disconnect the ignition cables from the ignition electrodes.
3. Remove the four nozzle stand plate screws that secure the nozzle stand plate in place. Remove the nozzle stand plate by pulling on the nozzle stand until the plate releases from the cast-aluminum blower casing.
4. Remove the four ignition coil screws that secure the ignition coil to the protection cap. Lift the ignition coil and disconnect the black (+) and brown (-) wires from the C-plug harness wires, prior to removing. Remove the protection cap from the diesel burner, so that the motor and clutch halves are exposed.
5. Remove the three hex-head screws that secure the motor and motor flange to the blower housing. Remove the motor and flange assembly along with the clutch halves.

Disconnect the motor's black (+) and brown (-) wires from the C-plug harness' wires.

6. Remove the four blower housing screws that secure the blower housing to the blower casing. Remove the blower housing so that the combustion air blower is exposed.
7. Spin the combustion air blower by hand. Placing one of the clutch halves to the end of the shaft, assists with the spinning of the bearings.
8. If the combustion air blower rotates smoothly, without any friction or noise, the bearings are in proper working condition. If the combustion air blower does not rotate smoothly and/or produces noise, the bearings are worn and must be replaced.

Bearings Replacement:

1. In order to perform the following procedure, it is necessary to detach and reattach the diesel burner head. Be sure to review the detaching and reattaching section on Page 44.
2. Locate and disconnect the C-plug harness wires that connect to the flame sensor and fuel solenoid. Disconnect the ignition cables from the ignition electrodes.
3. Remove the four nozzle stand plate screws that secure the nozzle stand plate in place. Remove the nozzle stand plate by pulling on the nozzle stand until the plate releases from the cast-aluminum blower casing,

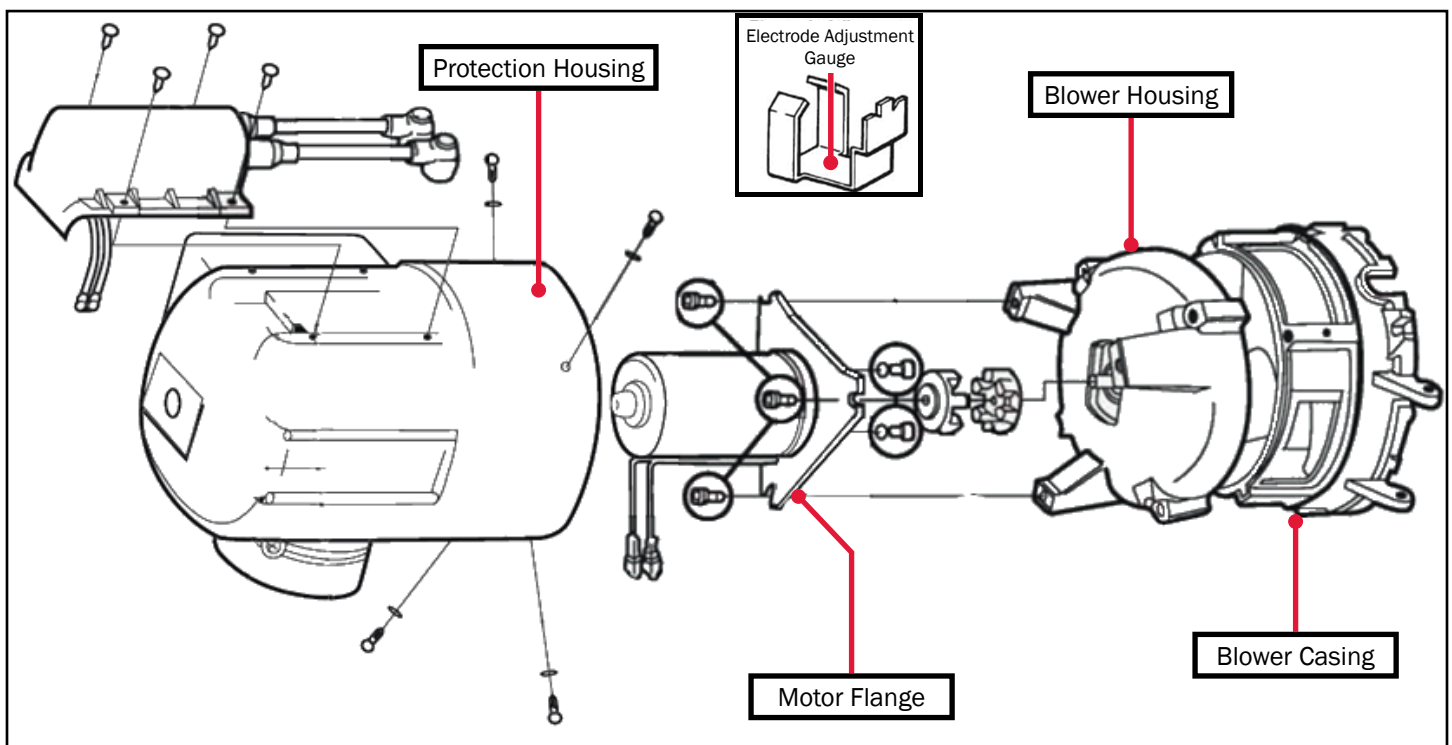

Figure 118

Burner Components

- Remove the four ignition coil screws that secure the ignition coil to the protection cap. Lift the ignition coil and disconnect its black (+) and brown (-) wires from the C-plug harness wires, prior to removing. Remove the protection cap from the diesel burner so that the motor and clutch halves are exposed.

NOTE: It is recommended to mark the internal components of the diesel burner prior to disassembling of the burner. Mark between the motor flange and the blower housing, and also between the blower housing and the blower casing. If the burner is assembled improperly, the protection cap will not go on.

- Remove the three hex head screws that secure the motor and motor flange to the blower housing. Remove the motor and flange assembly along with the clutch halves. Disconnect the motor's black (+) and brown (-) wires from the C-plug harness' wires.
- Remove the four blower housing screws that secure the blower housing to the blower casing. Remove the blower housing so that the combustion air blower is exposed.
- Hold side-B (see Figure 120b) of the blower casing and loosen the retaining nut located in side-A of the blower casing. Remove the retaining nut, steel drive gear and thick flat washer from the combustion air blower's shaft. Lightly tap the threaded end of the shaft so that the combustion air blower can be easily removed from the blower casing.
- With a pair of snap-ring pliers, remove the snap rings from both side-A and side-B of the blower casing. Push all the contents of the bearing kit out of the blower casing's bore/bearing cavity. Discard the retaining nut, steel drive gear, snap rings, bearings, spacer tube, and washers, as replacements are provided in the new bearing kit.
- Install a new snap ring into side-A of the blower casing. Once the snap ring is in place, insert the remaining contents of the new bearing kit into side-B of the blower casing, starting with the wave washer. Secure the bearing kit assembly in place with the remaining snap ring.

NOTE: Be sure to observe the placement of the three washers of the bearing kit. To ensure proper tension, the same order and direction of the dished surfaces of the washers must be followed when reassembling. See Figure 119.

- Inspect the combustion air blower for warping and/or damage. If warping or damage is visible, the combustion air blower must be replaced.
- Reference Figure 119 for exact placement of the three washers that slide over the threaded end of the combustion air blower's shaft prior to installation. Failure to follow the correct order and direction of the dished surfaces on the washers will result in a restricted rotation of the combustion air blower.

NOTE: Be sure to inspect the blower casing's bore/bearing cavity for signs of damage due to potentially seized bearings. If damage is present, the blower casing must be replaced.

- Slide the combustion air blower's shaft (with the three washers) up through the bearing kit assembly until the threaded portion appears on side-A of the blower casing. Place the new thick flat washer and steel drive gear on the threaded end of the combustion air blower's shaft. Thread the new retaining nut on the combustion air blower's shaft until it is finger tight (DO NOT TIGHTEN).
- Place a feeler gauge between the combustion air blower and the flat surface of the blower casing. Slowly tighten (or loosen) the retaining nut, holding the combustion air blower, until a .018 - .020 gap is achieved. Remove feeler gauge. Reference Figure 120a.
- Spin the combustion air blower to ensure a friction free rotation.

NOTE: If the combustion air blower is rubbing, loosen the retaining nut slightly, and lightly tap on the combustion air blower's shaft (opposite side) then readjust the gap.

- Reattach the blower housing to the blower casing using the four blower housing screws. Reinstall the clutch half on both the motor's shaft and the combustion air blower's shaft. Attach the motor and flange assembly, with the recessed edge of the motor flange in-line with the wiring access slot of the blower casing, to the blower housing with the three hex head screws. Reconnect the black (+) and brown (-) wires of the motor to the C-plug harness' black (+) and brown (-) wires. Feed the C-plug harness' yellow and brown wires back through the wiring access hole in the protection cap.

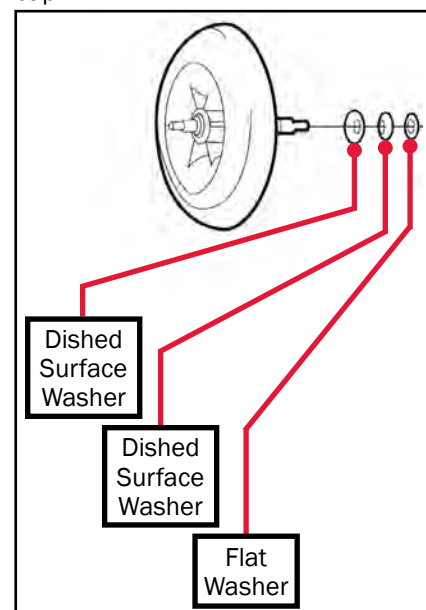

Figure 119

16. Reinstall the protection cap. Reconnect the black (+) and brown (-) wires of the ignition coil to the C-plug harness' yellow (+) and brown (-) wires. Reinstall the ignition coil and secure to the protection cap with the four ignition coil screws. Reconnect the ignition cables to the ignition electrodes.
17. Fit the nozzle stand plate inside the cast aluminum blower casing and secure in place with the four nozzle stand plate screws. Reattach the fuel supply and return lines to the diesel-burner head.
18. Follow the instructions for reattaching the diesel burner, in the detaching/reattaching section in this manual.

NOTE: Inspect the clutch halves for cracks and ensure the flat portion in each shaft hole is free of wear and tear. Too much play on the shaft produces a loud clacking noise. If any cracks or wear are detected, the clutch half must be replaced.

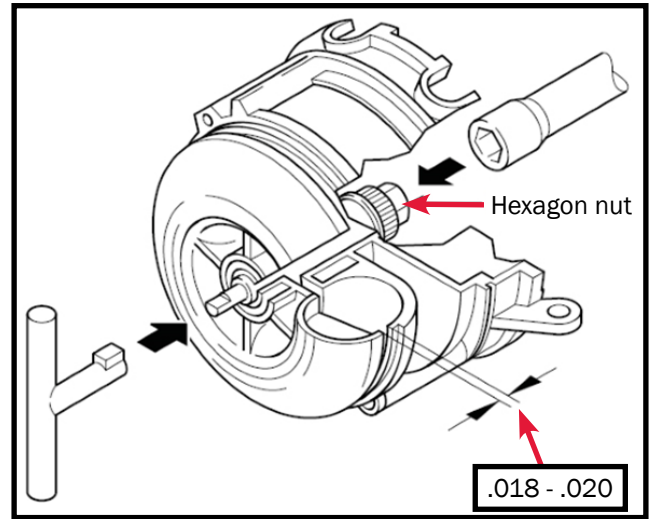

Figure 120a

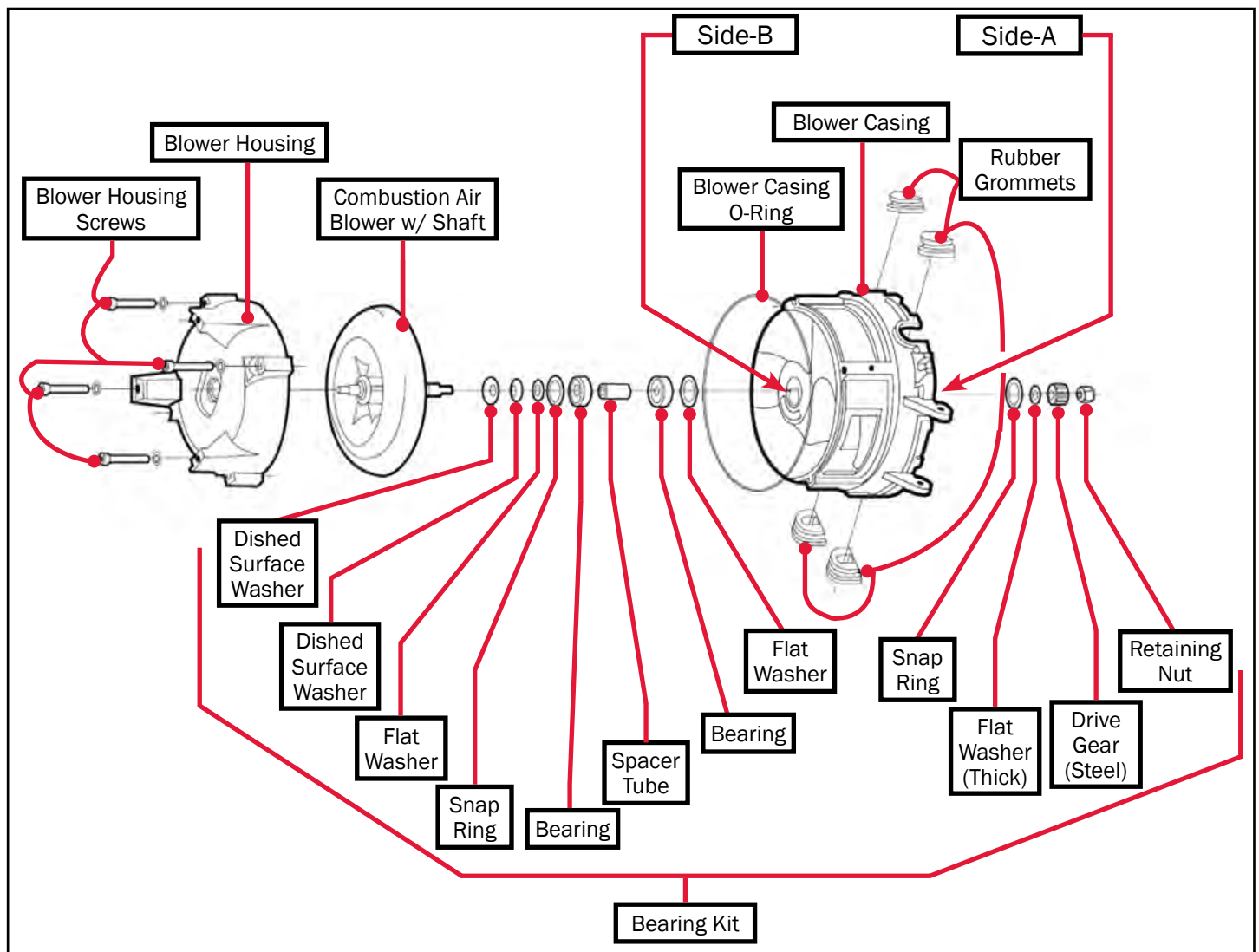

Figure 120b

Diesel Burner Controller



Figure 121

The diesel burner controller operates all the components of the diesel burner head and safely shuts the heater OFF in the event of an overheat, flame-out, and low voltage condition. It also receives diesel burner operation status signals from the flame sensor, control thermostat/ETS Module, and DC high-limit thermostat.

NOTE: Before troubleshooting the Diesel Burner Controller, verify that the Reporter has voltage at the pin shown in Figure 122. There will only be voltage on that pin if the Burner is showing ON on the Reporter screen.

NOTE: Some burner controllers are intermittent and will need to be tested numerously. If the burner controller tests well, and it still will not operate, it is possible there is an issue with the Reporter.

Component Test:

The following conditions must exist prior to performing the following diesel burner controller circuit tests. If one of the conditions below does not exist, please contact Technical Support at 574-247-9235, Option 1, for assistance.

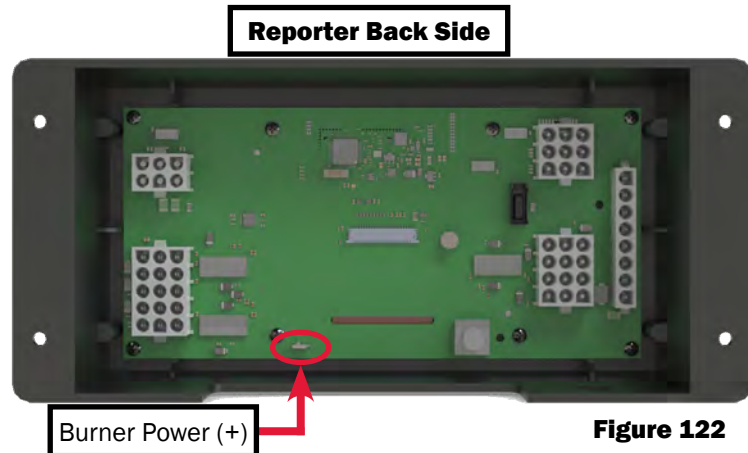

Figure 122

Condition 1:

A battery voltage level between 11.6-14 Volts DC must be present at the diesel burner controller during all testing. It may be necessary to perform a voltage check to ensure that this condition exists. To perform the voltage check, locate the controller's B-plug and insert the probes of a DC voltmeter into the B-4 (+) and B-2 (-) pins.

Condition 2:

A voltage level of between 11.6-14 volts must be present at the diesel ON/OFF switch circuit of the diesel burner controller during all testing. It may be necessary to perform a voltage check to ensure that this condition exists. To perform the voltage check, locate the controller's B-plug and insert the probes of a DC voltmeter into the B-1 (+) and B-2 (-) locations. Turn the diesel burner ON and observe the voltage levels.

Ground Circuit Test:

Locate the controller's B-plug and C-plug. Insert the probes of a DC voltmeter into the B-4 (+) and C-5 (-) locations and turn the diesel burner ON. If a voltage reading does not register on the voltmeter, the controller must be replaced. If voltage is present, proceed to the next test.

Control Thermostat/ETS Module Circuit Test:

Locate the diesel-burner controller's B-plug and C-plug. Insert the probes of a DC voltmeter into the C-1 (+) and B-2 (-) locations and turn the diesel switch ON. If a voltage reading does not register on the voltmeter, the

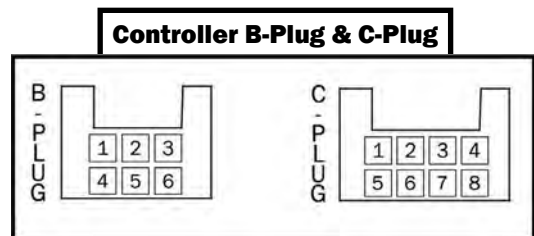

Figure 123

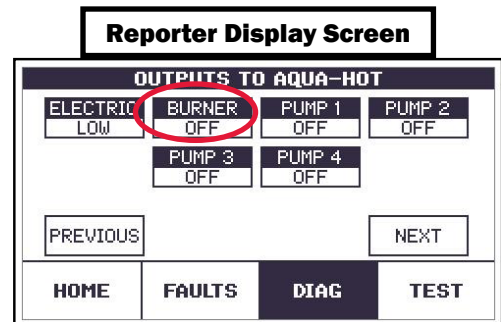

Figure 124

diesel-burner controller must be replaced. If voltage is present, proceed to the next circuit test.

DC High-Limit Thermostat Circuit Test:

Locate the diesel-burner controller's B-plug and C-plug. Insert the probes of a DC voltmeter into the C-4 (+) and B-2 (-) locations and turn the diesel switch ON. If a voltage reading does not register on the voltmeter, the diesel-burner controller must be replaced. If voltage is present, proceed to the next circuit test.

Motor Circuit Test:

Locate the diesel-burner controller's B-plug and C-plug. Use a jumper wire to make a connection from the C-1 location to the C-7 location. Turn the diesel switch ON and insert the probes of a DC voltmeter into the C-2 (+) and C-5 (-) locations. If no voltage reading registers on the voltmeter, the diesel-burner controller must be replaced. If voltage is present, proceed to the next circuit test.

NOTE: Be sure to remove the jumper wire that was used to make the connection from the C-1 location to the C-7 location. Failure to do so will result in an overheating condition during normal operation.

Ignition Coil Circuit Test:

Turn the diesel switch OFF and locate the diesel-burner controller's C-plug. Also, locate the VDC high-limit thermostat and disconnect its 2-way male plug from the (white plastic) 6-way female connector. Insert the probes of a DC voltmeter into the C-8 (+) and C-5 (-) locations and turn the diesel switch ON. If a voltage reading does not register on the voltmeter 18-25 seconds after the initial start-up, the diesel-burner controller must be replaced.

NOTE: Be sure to reconnect the VDC high-limit thermostat's 2-way male plug to the 6-way female plug. The diesel burner will not ignite during normal operation if the VDC high-limit thermostat is left disconnected.

Replacement Procedure:

1. Disconnect the Aqua-Hot from any and all power sources.
2. Remove the B-plug and C-plug from the controller. Gently slide out the controller from the side of the diesel burner.
3. Slide the new controller onto the side of the diesel burner.
4. Reconnect the B-plug and C-plug.
5. Test for normal operation.

NOTE: Be sure to install the controller with the plug ports facing downward. Failure to do so will result in moisture collecting in the ports and potential damage to the controller's internal circuitry.



Figure 125

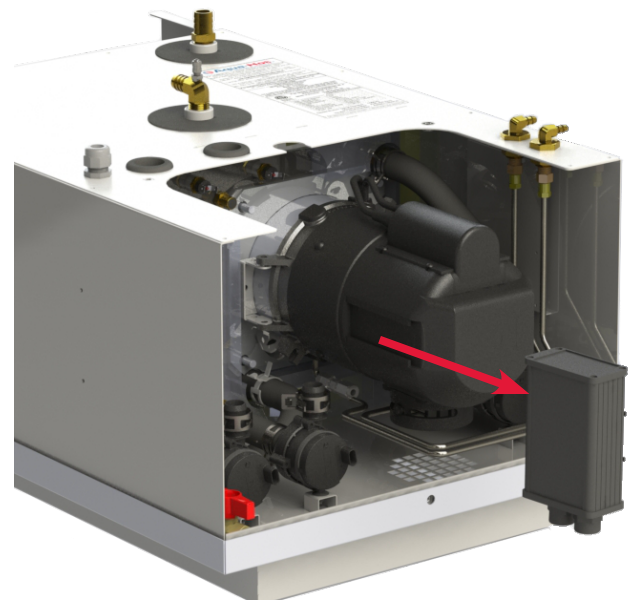

Figure 126

If the Aqua-Hot is Producing Black Smoke:

1. Things to check before opening up heater:

- Low Voltage - Fire up generator/plug coach into shore power
- Damaged or Restricted exhaust pipe - Inspect exhaust pipe for damage

2. Access cover must be removed to check the following:

- Air Intake Closed off - on the bottom of the burner is the air adjustment, set at the half way point.
- Broken Protection Cap - Check cap for cracks or missing pieces.
- Worn OUT Grommets - run hands over grommets, on top and bottom, and feel for excessive air
- Burner not seated properly or Loose - run hands along the seal of the burner, and check for excessive air
- Air Intake Sleeve collapsed

3. Diesel Burner must be removed to check the following:

- Photo Disc Bent or Tight - The photo disc must be loose, so it will seal on the combustion chamber properly
- Combustion Chamber Warped/Melted - Inspect for signs of warping/melted aluminum.
- Bad Nozzle - If nozzle is spraying poorly, it must be replaced
- Fuel Pressure not at 145 PSI - Check fuel pressure with fuel pressure gauge

4. Diesel Burner must be torn down to check the following:

- Slow Motor (Less Than 4500rpms at 12v) - a slow motor acts the same as low voltage. Check motor RPM with an RPM tester, under full load.
- Bearings are worn out - Bearings should spin freely, and sound smooth. If they are starting to seize up, they will slow the motor down.
- Impeller Fan Not Gapped Properly - The impeller needs to be gapped at .018-.020, or tighten fan down until it rubs, back it off ¼ turn.

If the Aqua-Hot is Producing Blue/White Smoke:

1. If the Heater smokes on start up or shut down:

- Fuel Solenoid
 - Plunger could be worn out
 - Plastic or metal in the way of the plunger
 - Fuel solenoid could be operating intermittently
- Nozzle Tower
 - Could be cracked
 - Poorly machined
- Short-cycling
 - The control thermostat or ETS Module could be defective
 - Someone turned the heater on/off repeatedly

2. If the Heater smokes during the burn cycle:

- Electrodes out of adjustment
- Air in the fuel system
- Bad fuel nozzle
- Fuel pressure is not at 145 PSI
- Fuel pump
- Intermittent Ignition Coil
 - If the coil doesn't turn on, diesel fuel sprays for 20 seconds, before the photo eye shuts the fuel off.

If one of the Aqua-Hot Heating Zones will not get hot:

1. General Issues:

- Diesel/Electric not operating (coolant is cold)
- Heater is not up to operating temperature
- Interior Zone Thermostat is not calling for heat
- Zone Circulation Pump Not operating
- Heat Exchanger Fans Not Operating
- The Low-Temperature Cutoff is not ON
- The Reporter is wired incorrectly
- Not enough heat exchangers installed
- Heat exchangers improperly installed

2. If the Fans and Pumps ARE running:

- Stuck Check Valve
- Kinked Line
- No antifreeze in the system
- System could be air-locked

If there is a Lack of Domestic Hot Water:

1. General Information:

- The heater is only rated for water flow of 1.5 GPM.
- The heater is only rated for a 55°F temperature rise on the cold water coming into the unit.
- The diesel burner must be on for continuous hot water - the electric element is for limited, light duty use only.

2. Things to test for with a lack of hot water issue:

- Aqua-Hot heater bypassed
- Outside water faucet is left on
- Washing machine valve defective
- Antifreeze concentration is incorrect
 - 30-50% antifreeze concentration
- Operating range of the heater (Control Thermostat/ETS Module) is incorrect
 - Temperature range of tank should be between 155°F - 185°F
- Water flow is too fast
 - Must be 1.5 GPM or less
- Mixing/Tempering valve is stuck (knob does not turn freely)
- Low Temperature Cutoff Thermostat is not functioning properly
 - Needs to trip within 1-2 minutes when running hot water
 - Needs to turn the stir pump on, if the diesel burner is ON as well
- Stir pump is not functioning properly
 - Needs to be running when the diesel burner is ON, and the Low Temperature Cutoff thermostat is tripped.
 - Hold onto both upper and lower hose to make sure both get hot.

If the Antifreeze is Leaking:

NOTE: To find an antifreeze leak, the system must be HOT (up to operating temperature), OR pressurized to 15PSI.

Inspect the following components on the Aqua-Hot system for leaks:

On the Front Side of the Aqua-Hot:

1. Fluid Level Sensor
 - It might be necessary to cut away some of the insulation around the fluid level sensor to locate the leak.
2. Control Thermostat/ETS Module
 - It might be necessary to cut away some of the insulation around the Control Thermostat/ETS Module to locate the leak.
3. Drain Valve and Hose going to the drain valve
4. Electric Element
5. Circulation/Stir Pump
 - Hoses
 - Tank Ports
 - It might be necessary to cut away some of the insulation around the tank ports to locate the leak.
 - Pump
6. Burn Chamber Leak
 - If antifreeze is running out of the tip of the exhaust pipe, remove the burner and combustion chamber, and inspect inside of the burn chamber for leaks.

On the Top Side of the Aqua-Hot:

1. Expansion Tank Connection
 - Cracked expansion tank tubing
 - Loose air release valve
 - Brass hose barb fitting defective or loose
2. Return Ports
 - Defective fitting
 - Leaking Fitting

On the Rear Side of the Aqua-Hot:

1. Copper Pipe
 - The copper pipes come out of the tank so they can be possible points of antifreeze leaks. Either where the brass fittings go into the tank, or at the copper pipe where they go through the brass fittings.

NOTE: If no leaks are found on the Aqua-Hot, it is possible that there is a leak within the motor home. Check all heat exchangers, connections, and tubing for leaks.

Wire Gauge Information:

Because all Aqua-Hot heating systems are designed to operate only when there is an adequate supply of DC (Direct Current) voltage, it is imperative that the proper wire gauge be determined and used for the DC power supply and ground wires. This section addresses how to determine the DC amperage draw of the heating system, including heat exchangers, and how to determine the proper wire gauge based upon those findings for a specific application.

Aqua-Hot Model	Base DC Amp Draw*
450DE	19 Amps
450DM	19 Amps
* Excludes heat exchangers	

On the Front Side of the Aqua-Hot:

1. Review the chart above for the amperage draw of the Aqua-Hot heater

NOTE: Each heating zone "FAN" circuit can supply up to 2.0 amps of direct current.

2. Determine the number of heat exchangers installed with the heating system.

NOTE: Each Aqua-Hot Cozy heat exchanger draws 0.23 amps of direct current. Each Aqua-Hot Whisper heat exchanger draws 0.38 amps of direct current.

3. Consult the heat exchanger's manufacturer for amp-draw information
4. Determine the total amperage draw for all heat exchangers installed.
 - For example, if six Aqua-Hot Cozy heat exchangers have been installed, multiply the amperage draw of each heat exchanger (0.23 amps) by the number of heat exchangers (6). The total amperage draw in this scenario would be 1.38 amps.
5. Add the total heat exchanger amperage draw to the amperage of the installed Aqua-Hot.
 - For example, an Aqua-Hot 450DE with six Cozy heat exchangers has a total amperage draw of 20.38 amps.

Determining the Proper Wire Gauge:

1. Measure the total length of wire required for the distance between the vehicle’s battery and the Reporter for the 450D.
2. Using the determined length and total amperage draw, consult the wire gauge chart included in this section. Round up to the closest amp draw listed on the left, then round up to the closest length at the top of the chart.
 - For example, the 450D heater with six Cozy heat exchangers with the Reporter placed 15 feet from the vehicle’s battery would require an 8-gauge wire.

Wire Gauge Chart:

CONDUCTOR SIZING TABLE - MAXIMUM 10% VOLTAGE DROP - (12VDC)																					
CURRENT DRAW (AMPS)																					
	1	2	3	4	5	6	7	8	9	10	15	20	25	30	40	50	60	70	80	100	
MAXIMUM LENGTH OF SAE CONDUCTOR (in feet) FROM SOURCE TO DEVICE																					
GAGE																					
20	107	53	36	27	21	18	15	13	12	11	7										
18	172	86	57	43	34	29	25	21	19	17	11	9									
16	261	130	87	65	52	43	37	33	29	26	17	13	10								
14	413	207	138	103	83	69	59	52	46	41	28	21	17	14							
12	651	326	217	163	130	109	91	81	72	65	43	33	26	22	16						
10	1043	521	348	261	208	174	149	130	116	104	70	52	42	35	26	21	17				
8	1653	827	551	413	331	276	236	207	184	165	110	83	66	55	41	33	28	24	21		
6	2892	1446	954	723	578	482	413	362	321	289	193	145	116	96	72	58	48	41	36	29	
4	4170	2085	1390	1043	834	695	596	521	463	417	278	209	167	139	104	83	70	60	52	42	
MAXIMUM LENGTH OF AWG CONDUCTOR (in feet) FROM SOURCE TO DEVICE																					
20	115	57	38	29	23	19	16	14	13	11	8										
18	182	81	61	45	36	30	26	23	20	18	12	9									
16	288	144	96	72	58	48	41	36	32	29	19	14	12								
14	458	229	153	115	92	76	65	57	51	46	31	23	18	15							
12	729	364	243	182	146	121	104	91	81	73	49	36	29	23	19						
10	1159	579	386	290	232	193	166	145	129	116	77	58	46	39	29	23	19				
8	1738	869	579	435	348	290	248	217	193	174	116	87	70	58	43	35	29	25	22		
6	2930	1465	977	733	586	488	419	366	326	293	195	147	117	98	73	59	49	42	37	29	
4	4659	2330	1553	1165	932	777	666	582	518	466	311	232	186	155	116	93	78	67	58	47	

Instructions for Checking Fuel Pressure:

NOTE: A fuel pressure gauge is used to properly check the fuel pump's pressure setting. The fuel pump is preset to 145 PSI. Perform the following procedure to check for a proper fuel pressure setting.

Step 1: Remove the diesel burner

Refer to the section on detaching the diesel burner on page 44.

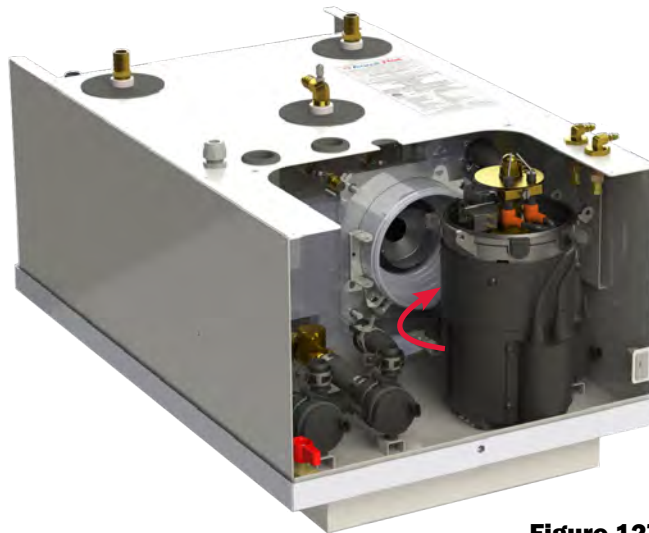

Figure 127

Step 2: Install the fuel line bypass fittings onto the diesel burner.

1. Locate the 1/4" fuel tube unions on the bottom side of the diesel burner.

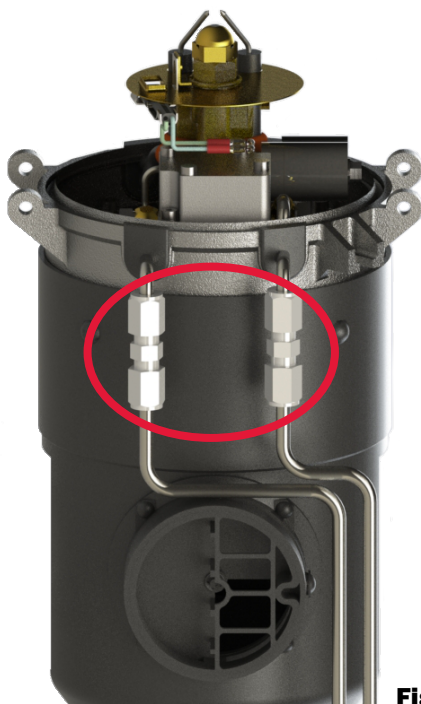

Figure 128

2. Using a 13mm and a 9/16" wrench, remove the steel fuel lines from the diesel burner.



Figure 129

3. Using a 13mm and a 9/16" wrench, install the fuel bypass fittings onto the diesel burner.

Step 3: Install the fuel pressure gauge

1. Using a $\frac{5}{8}$ " and $\frac{3}{4}$ " wrench, remove the fuel nozzle.



Figure 130

2. Using a $\frac{5}{8}$ " and $\frac{3}{4}$ " wrench, install the fuel pressure gauge.



Figure 131

Step 4: Running burner off an external fuel source

1. Using an external fuel source and rubber fuel lines, hook the burner supply and return fuel lines up to run off the external fuel source.



Figure 132

WARNING

A spark will appear across the ignition electrodes for a brief moment after the diesel burner has been activated. DO NOT attempt to make any fuel pressure adjustments until the spark has disappeared. Failure to do so may result in serious bodily injury. In some installments, it may be necessary to shine a light on the flame sensor to simulate a flame condition to shut off the ignition coil.

2. Turn the diesel burner ON, either on the switch panel or the coach control panel. A pressure will register on the fuel pressure gauge once the fuel solenoid opens (after approximately 10-20 seconds).

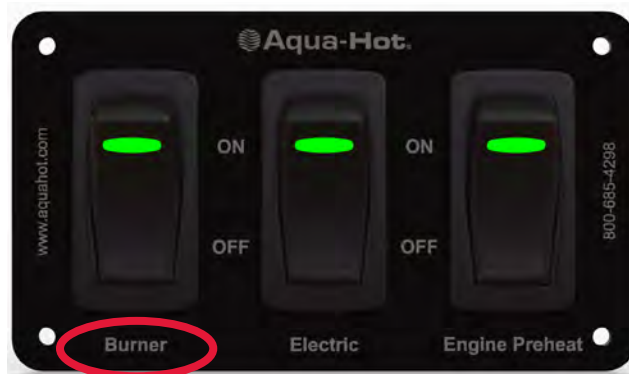

Figure 133

Instructions for Adjusting Fuel Pressure:

Step 1: Follow the directions for Adjusting the Fuel Pressure

1. Using an external fuel source and rubber fuel lines, hook the burner supply and return fuel lines up to run off the external fuel source.



Figure 134

! WARNING

A spark will appear across the ignition electrodes for a brief moment after the diesel burner has been activated. **DO NOT** attempt to make any fuel pressure adjustments until the spark has disappeared. Failure to do so may result in serious bodily injury. In some installments, it may be necessary to shine a light on the flame sensor to simulate a flame condition to shut off the ignition coil.

2. Turn the diesel burner ON, either on the switch panel or the coach control panel. A pressure will register on the fuel pressure gauge once the fuel solenoid opens (after approximately 10-20 seconds).

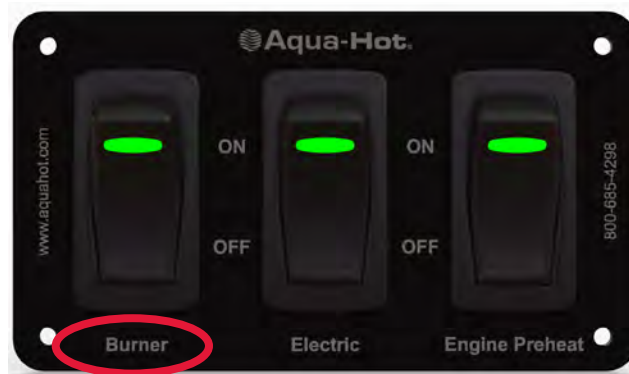
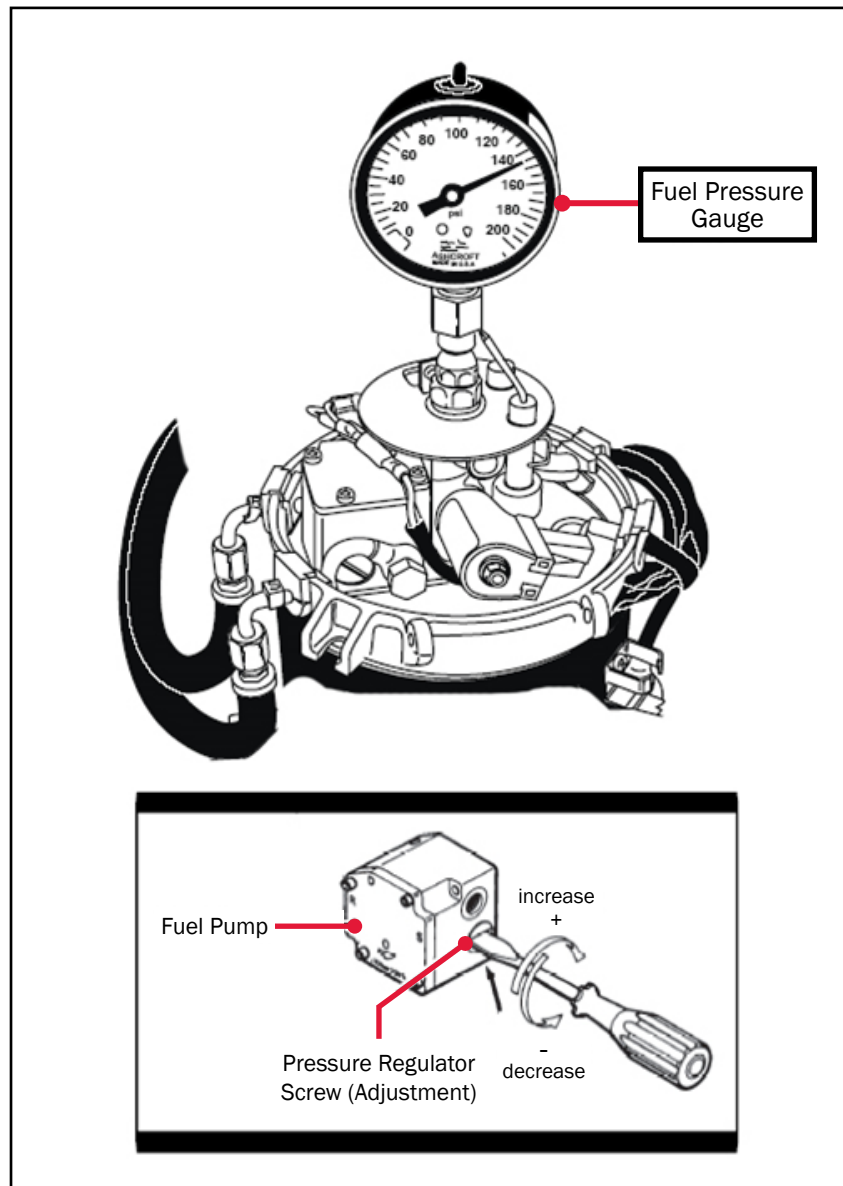

Figure 135

Step 2: Adjust the Fuel Pressure to 145 PSI

1. Once the fuel solenoid has been activated, and the fuel pressure gauge is registering a pressure, the fuel pressure can be adjusted. To increase the fuel pressure turn the pressure adjustment screw clockwise, and to reduce the fuel pressure, turn the pressure adjustment screw counter clockwise.

**Figure 136**

NOTE: If the fuel pressure cannot be adjusted, refer to the fuel pump section on Page 62 for more information and troubleshooting instructions.

Extreme Cold Weather Operation



WARNING

When storing the motor home: not winterizing the Aqua-Hot when freezing temperatures are present will result in serious damage to the Aqua-Hot's Domestic Water Heating System. Also, be sure to use a FDA-Approved "GRAS" rated antifreeze for winterization.

NOTE: The Aqua-Hot can continue to be used for interior zone heating once the domestic water heating system has been drained and winterized.

120V AC Electric Element

Please note that the 120V AC Electric Heating Element is the Aqua-Hot's *secondary heat source* for heating both the interior and/or the domestic hot water during low heating demand situations (such as when moderate ambient temperatures exist and/or when there is a low demand for domestic hot water).

If the 120V AC Electric Heating Element is not providing enough heat, turn the diesel burner ON in conjunction with the 120V AC Electric Heating Element.

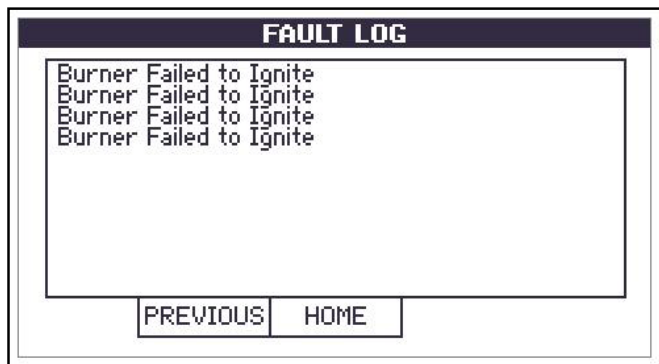

Figure 137

Diesel Burner

If the Diesel Burner fails to operate:

- Determine if the diesel fuel in the motor home is winter or summer fuel
- Verify that the diesel fuel is liquid and not jelled
- Make sure the electrodes are properly adjusted
- Determine when the last annual service was performed
- Check the Reporter for any faults (see Figure 137)

Things to Check for Lack of Interior Heat:

1. Diesel burner must be on
2. Diesel burner operating properly
3. Antifreeze concentration in the boiler tank must be between 30-50%
4. Heating system must be properly installed according to the 450D Installation manual
 - At least 5 heat exchangers installed in the interior of the coach
 - Must be cold air returns installed for every heat exchanger (reference Figure 139)
 - Heat exchangers should be mounted as close to the hot air outlet grill as possible (Figure 138)

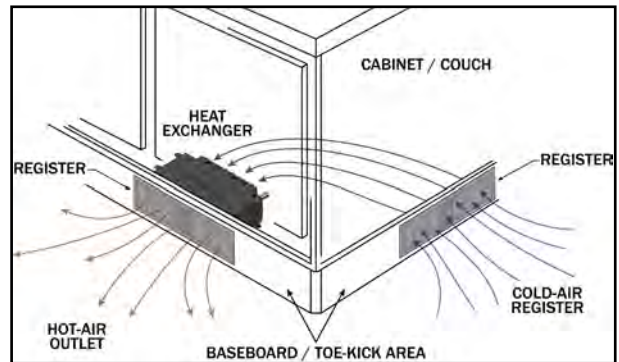

Figure 138

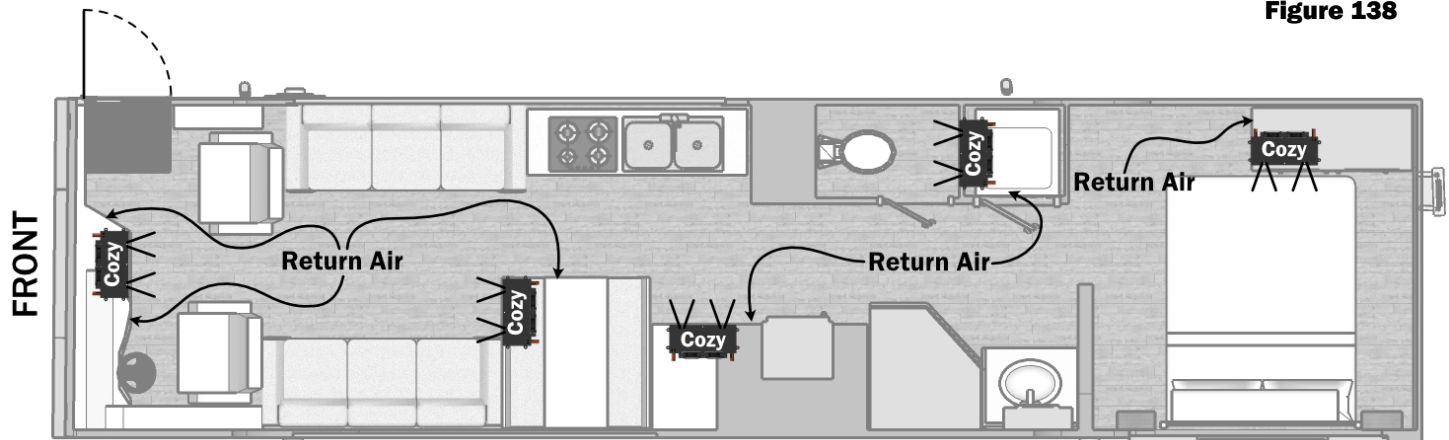

Figure 139

Aqua-Hot Maintenance

Monthly Maintenance:

Check the antifreeze and water heating solution to ensure that it is at the proper level by visually checking the solution level in the expansion tank. The level of the antifreeze and water heating solution within the expansion tank should only be checked when the Aqua-Hot is at maximum operating temperature.

If additional antifreeze and water heating solution is required, fill the expansion tank to the "HOT" level mark. Reference Figure 140. Be sure to reference page 8 for the type of antifreeze and heating solution.

Additionally, it is recommended that the diesel burner be fired and allowed to run monthly to keep it in good working order.

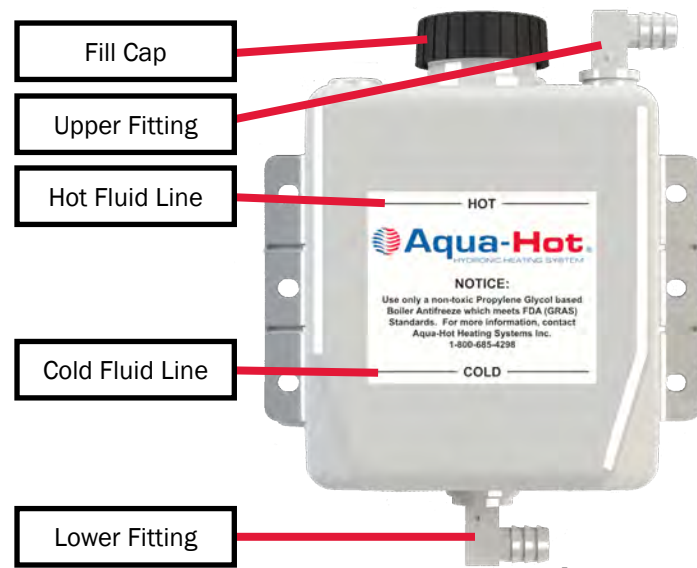

Figure 140

DANGER

Failure to disconnect all power supplies and/or to allow the heater to cool before servicing could cause serious damage or personal injury.

Annual Maintenance:

To keep the Aqua-Hot running smoothly, it is recommended to have the diesel burner tuned up annually or after the coach has been stored unused for a long period of time. A tune-up should consist of a new fuel nozzle and fuel filter, along with a thorough cleaning of the combustion chamber. To ensure maximum diesel burner performance, always use the recommended fuel nozzle and fuel filter when replacing these parts.

NOTE: Be sure to use care when handling the fuel nozzle. Oils and/or small dust or dirt particles from hands may plug the nozzle's small orifice. A partially plugged orifice will restrict fuel flow, which will affect the combustion process of the diesel burner.



Figure 141

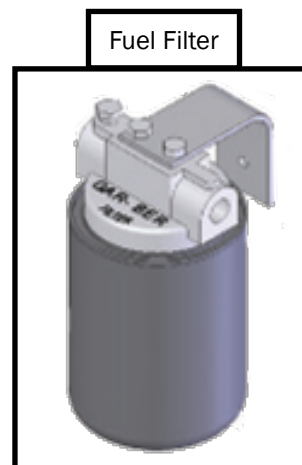

Figure 142

Aqua-Hot Maintenance Procedure

NOTE: Before performing an annual maintenance, it is recommended to test run the diesel burner. While testing, inspect the exhaust for smoke.

Step 1: Test Run the Diesel Burner

1. Turn the diesel burner ON, either on the interior switch panel or coach control panel.
2. After the diesel burner has ignited, inspect the exhaust for smoke.
3. Shut the diesel burner off and wait for unit to completely shut down.

NOTE: The diesel burner can either be shut off by:

- Turning the diesel burner switch to the OFF position
- Disconnecting the control thermostat/ETS Module wires
- Unplugging the diesel burner controller (Figure 144)

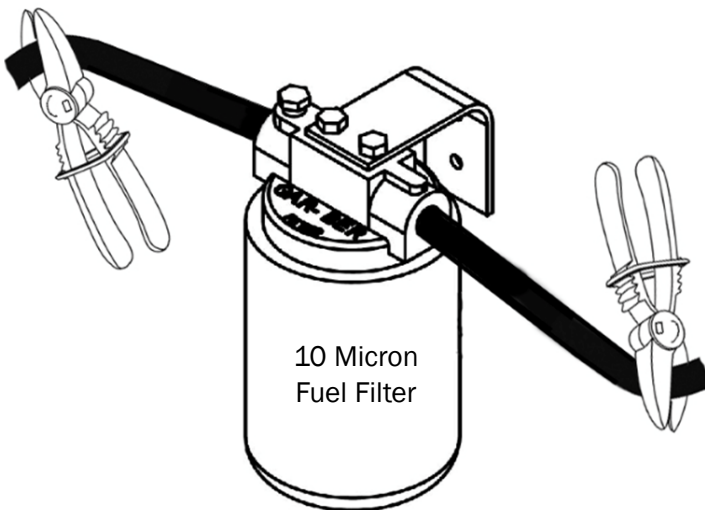

Figure 143

Step 2: Replace the Fuel Filter

1. Locate the fuel filter
2. Using hose pinch off pliers, clamp off both fuel lines going to the fuel filter. Reference Figure 143.
3. Remove the old fuel filter. Replace the fuel filter with the proper replacement canister.
4. Remove the hose pinch off pliers.

Step 3: Run the Diesel Burner

1. Turn the diesel burner ON.
2. After the diesel burner has ignited, let it burn for 1-2 minutes to purge the old fuel out of the nozzle holder, to prevent contamination of the replacement nozzle.
3. Shut the diesel burner OFF, and wait for the unit to completely shut off.

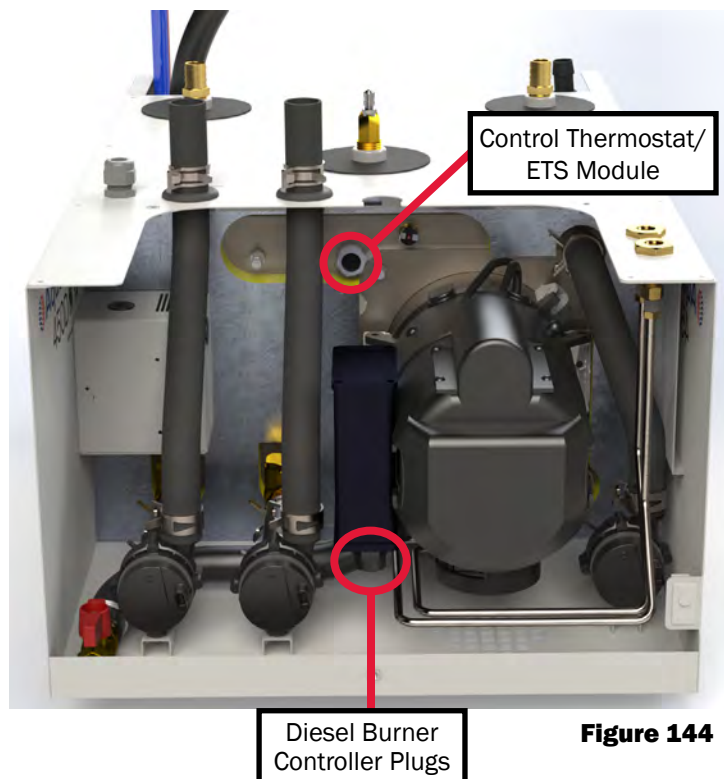

Figure 144



CAUTION

Be sure to clamp off the fuel supply and return lines at the ports on top of the Aqua-Hot PRIOR to beginning this replacement procedure.

Step 4: Remove the Diesel Burner

1. Locate the diesel burner's controller and disconnect both plugs.
2. Using a $\frac{7}{16}$ " wrench, loosen the nuts securing each fuel line to the Aqua-Hot.
3. The diesel burner is secured to the Aqua-Hot with two nuts that can be loosened and swung out of the way by using a 10mm socket wrench with a 10 inch long extension.

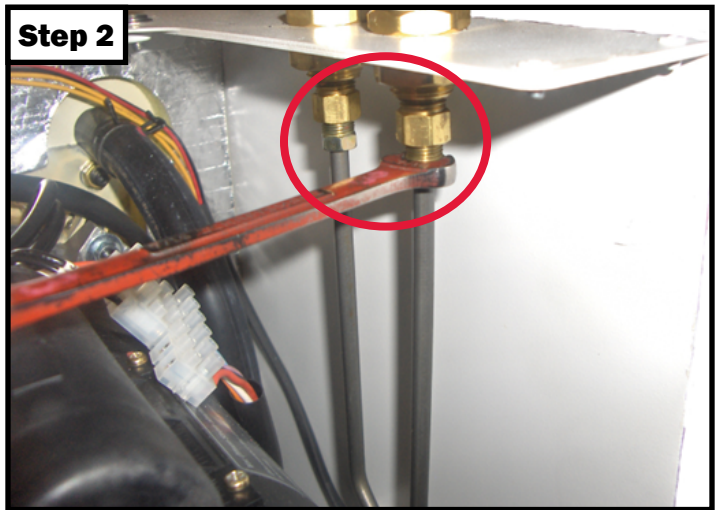

Figure 147



Figure 145

Step 1

Diesel Burner Controller



Disconnect both Diesel Burner Controller Plugs

Figure 146

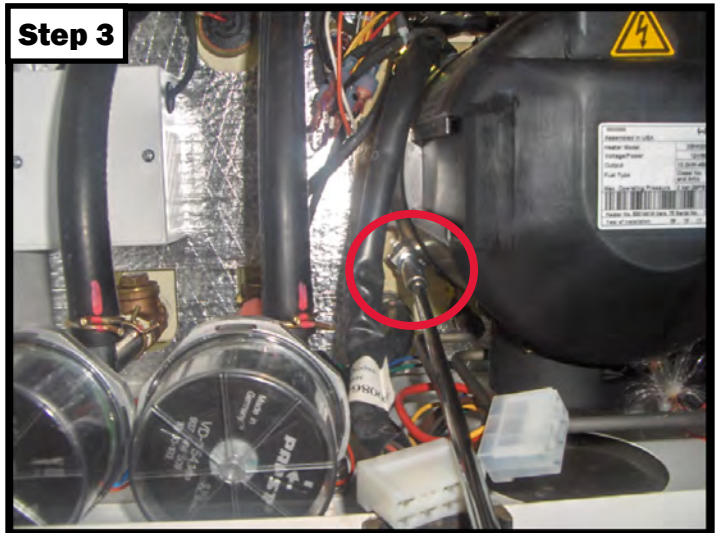

Figure 148

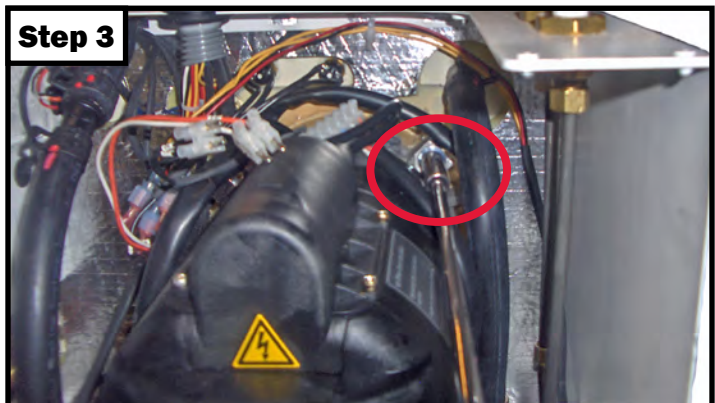

Figure 149

Step 2

Step 3

Step 3

Aqua-Hot Maintenance Procedure

NOTE: To remove the diesel burner, it may be necessary to disconnect the Control Thermostat/ETS Module and High-Limit Thermostats from the diesel burner's thermostat plug.

Step 4: Remove the Diesel Burner (continued)

1. Carefully pull the diesel burner away from the Aqua-Hot 4 - 5 inches before rotating the burner, then remove completely as shown in Figure 150.

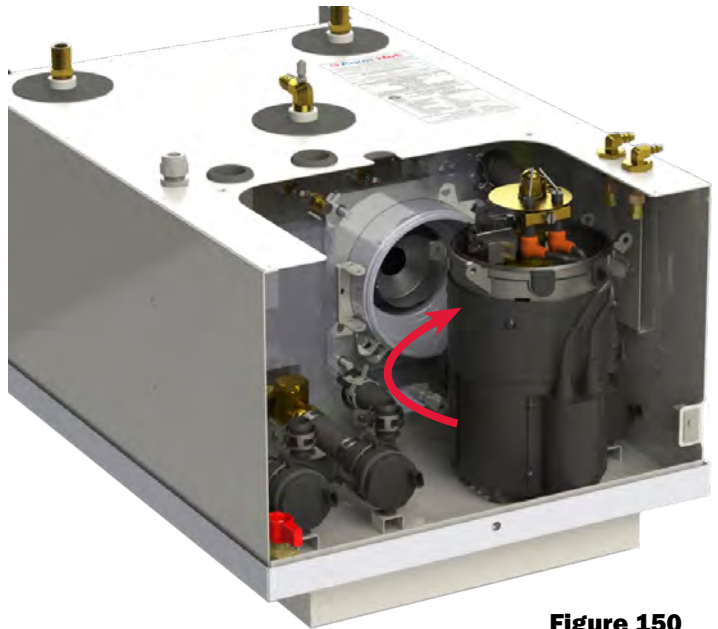

Figure 150



DANGER

Use caution when handling the combustion chamber, it may be extremely hot and serious burns could result from touching a hot combustion chamber.

Step 5: Clean and Inspect the Combustion Chamber and Heat Transfer Tabs

1. Remove the combustion chamber by loosening and removing the four nuts, securing the combustion chamber to the boiler tank and pulling it straight out, approximately 16 inches.
2. Once the combustion chamber has been removed, use a long handled wire brush, and brush the heat transfer tabs to loosen soot deposits. Failure to do so will reduce the Aqua-Hot's heat transfer capabilities.

NOTE: If the heat transfer tabs are excessively sooty, it may be necessary to vacuum the soot out of the heat transfer tabs. If there is minimal soot, it may be left in the heat transfer tabs, and will be evacuated out of the exhaust pipe, upon start up of the diesel burner.

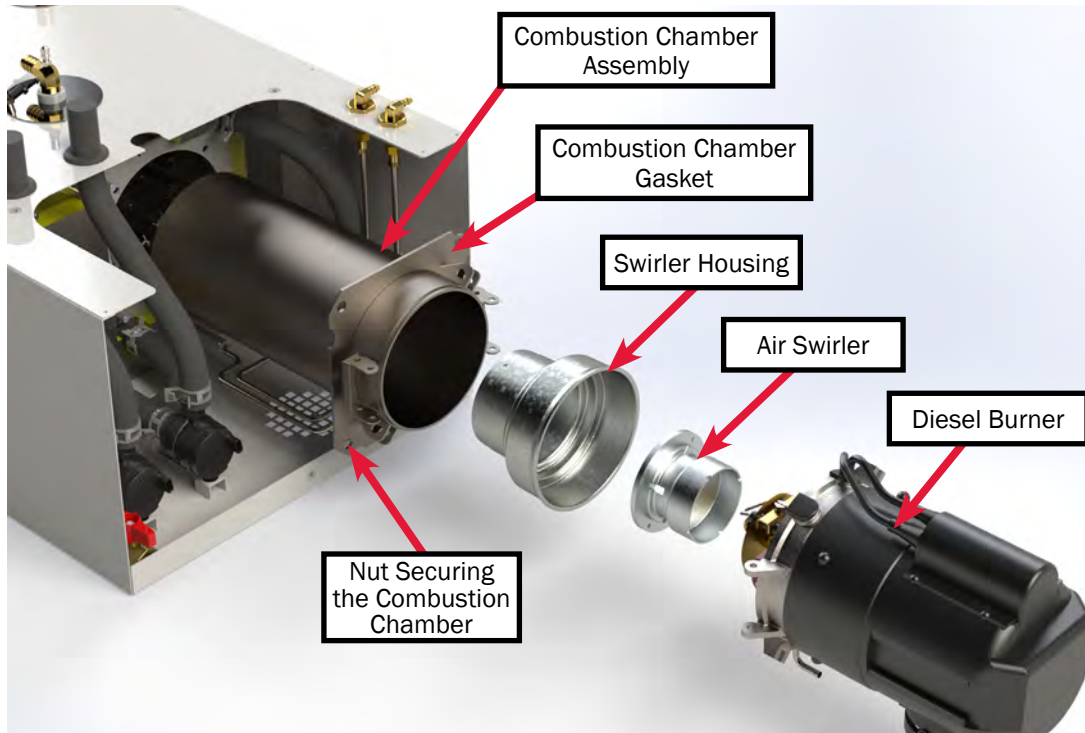

Figure 151

Step 5: Clean and Inspect the Combustion Chamber and Heat Transfer Tabs (continued)

3. Inspect the Combustion Chamber assembly and Air Swirler for damage or signs of warping.

- Inspect the outer ring that the photo disc seats against for signs of warping.
- Inspect the back side of the Air Swirler for signs of warping between screws.

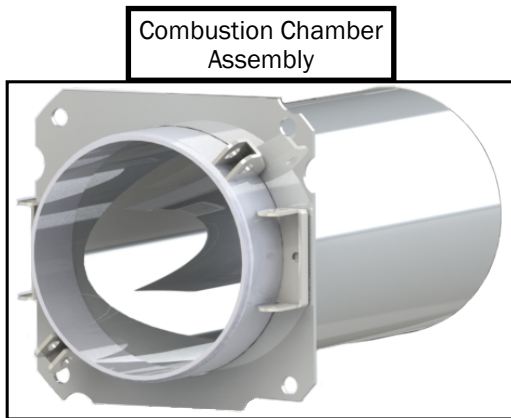

Figure 152

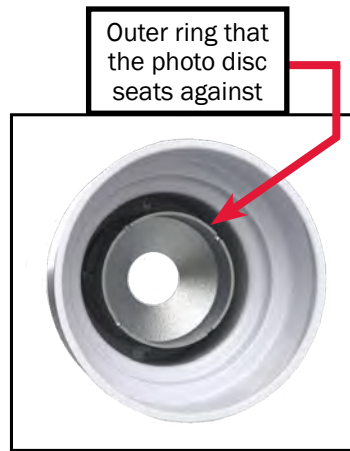

Figure 153

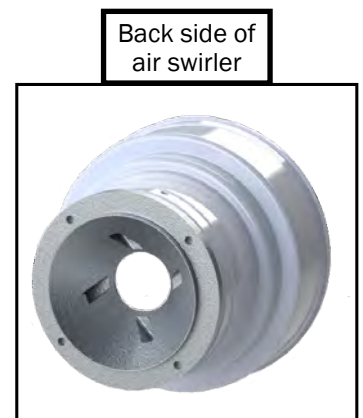

Figure 154

CAUTION

Failure to reinstall the combustion chamber will result in serious damage to the diesel burner.

NOTE: It will be necessary to replace the combustion chamber gasket any time the combustion chamber is removed.

Step 6: Reinstall the Combustion Chamber

1. Reinstall the Combustion Chamber assembly and the Air Swirler into the Aqua-Hot.

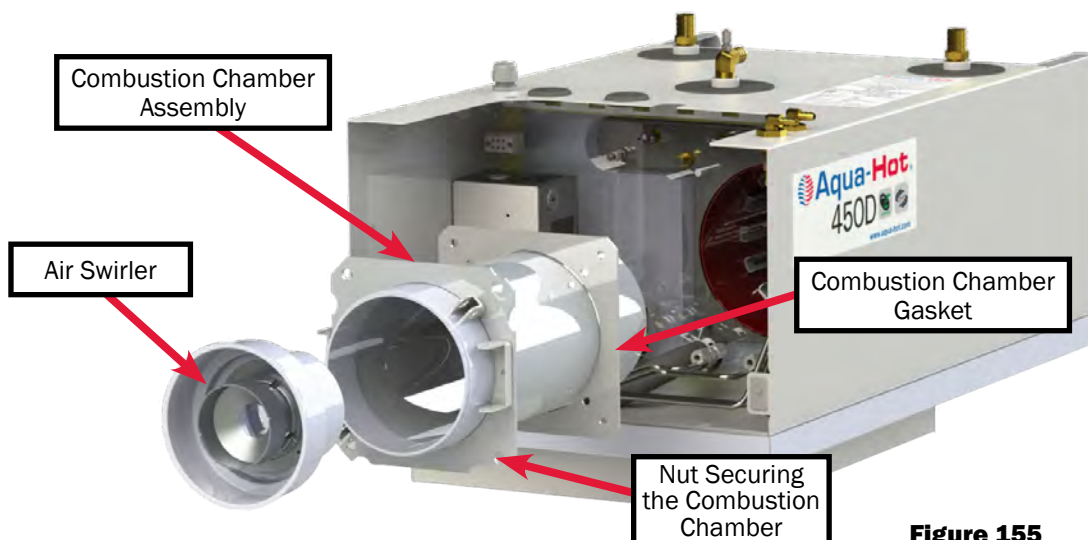

Figure 155

Step 7: Inspect the Diesel Burner

1. Reinstall the Combustion Chamber assembly and the Air Swirler into the Aqua-Hot.

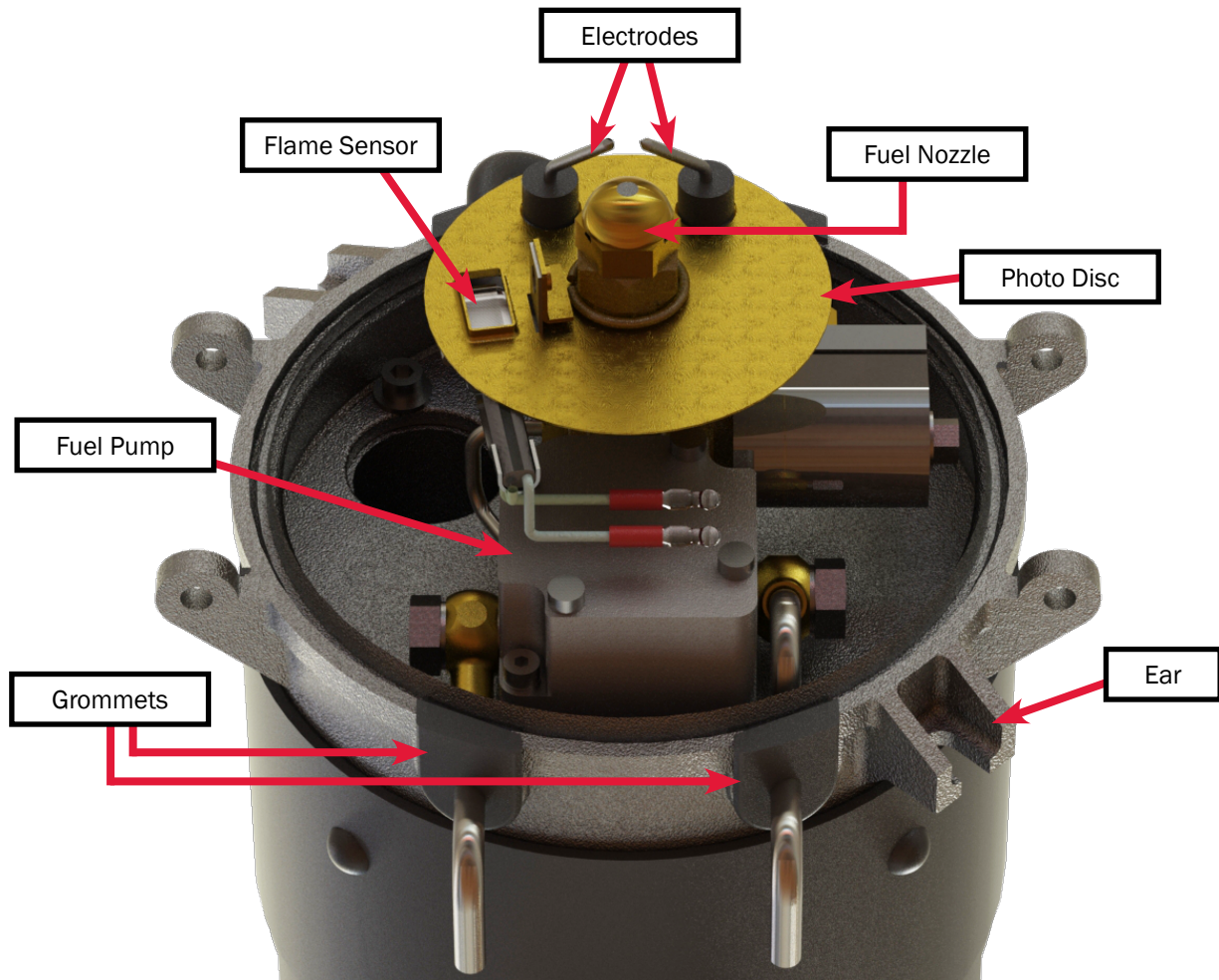

Figure 156

Inspect the following:

1. Electrodes
 - Damaged
 - Improperly adjusted
2. Fuel Pump
 - Leaks
3. Photo Disc
 - Warped
 - Bent
4. Harness & Ignition Coil Wires
 - Cracked or bare wires
 - Hard or brittle wires
5. Flame Sensor
 - Cracked
 - Overheated (purple color)
 - Melted wires
 - Dirty
6. Rubber Grommets
 - Hard or brittle
 - Rubber has been cut out
 - Right & left properly positioned
7. Broken or cracked "Ears"
 - Due to over-tightening of eye-bolts

Step 8: Clean Ignition Electrodes and Flame Sensor

1. Ignition Electrodes
 - Polish away any carbon deposits that may have baked onto the metal tips of the ignition electrodes with a coarse sponge.
2. Flame Sensor
 - For light dirt, dust, and/or carbon deposits, simply wipe off the flame sensor with a soft cloth.
 - Should heavy carbon deposits be present, completely remove the flame sensor from the photo disc and clean with brake cleaner.

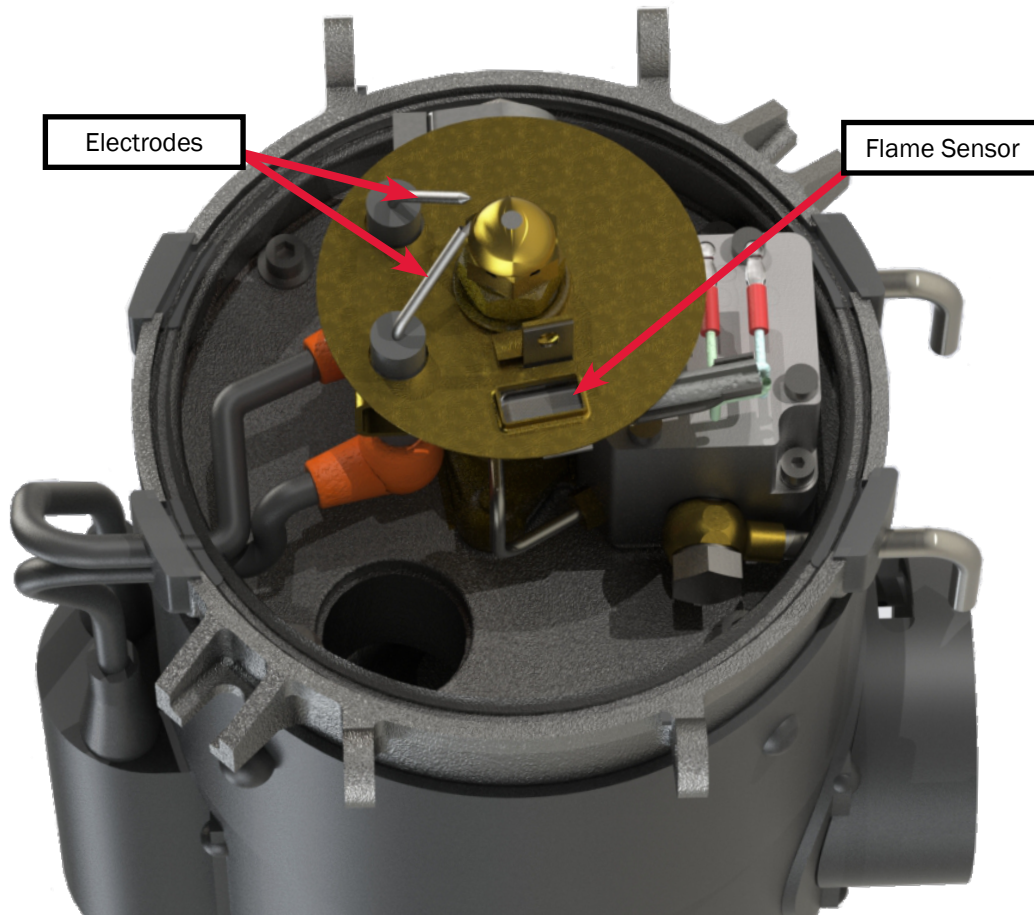

Figure 157

Step 9: Replace Fuel Nozzle

1. Use a $\frac{3}{4}$ " wrench to hold the fuel nozzle manifold hex, while loosening the fuel nozzle with a $\frac{5}{8}$ " wrench and remove.
2. When replacing the fuel nozzle, be sure to tighten the nozzle, loosen it a $\frac{1}{4}$ turn, and then firmly re-tighten. This will establish a seated fit and avoid any leaks.

NOTE: Be sure to use care when handling the new fuel nozzle. Oils and/or small dust or dirt particles from your hands may plug the nozzle's small orifice. A partially plugged orifice will restrict fuel flow, which will affect the combustion process of the diesel burner.

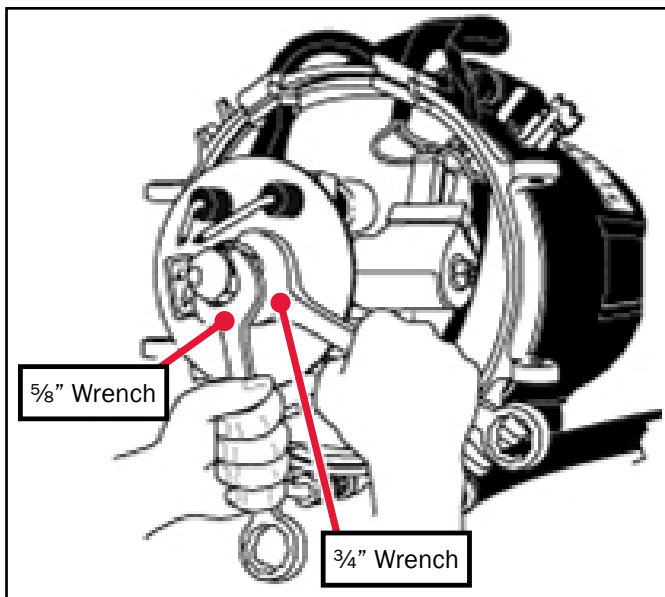

Figure 158

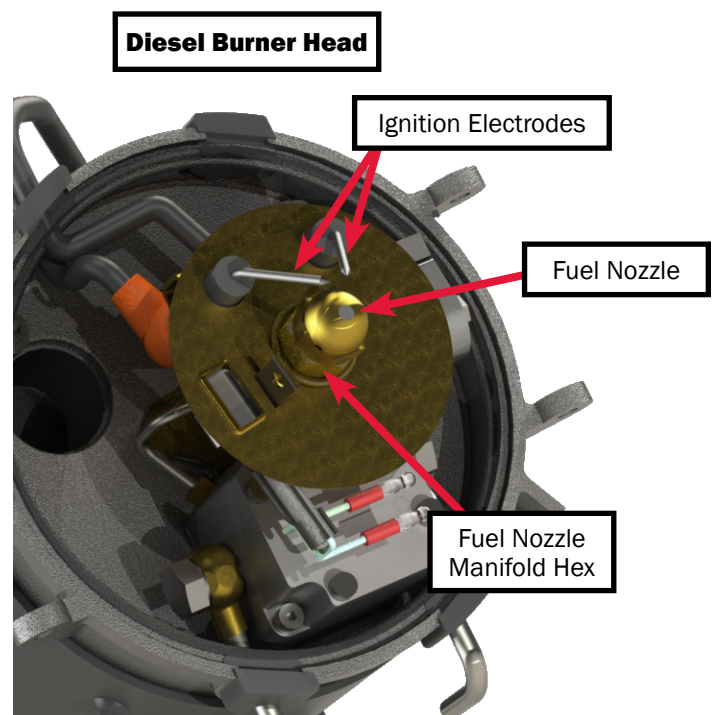

Figure 159



DANGER

Be sure to reattach the diesel burner head prior to switching the heater ON. Failure to do so may result in ignition of the diesel burner and serious bodily injury.

Step 10: Adjust Ignition Electrodes

1. Using a 10mm socket, slightly loosen the retaining clamp bolt.
2. Place the electrode adjustment gauge on the nozzle manifold hex and insert the metal tips of the ignition electrodes into the appropriate notches of the electrode adjustment gauge.
3. Using a 10mm socket, tighten the retaining clamp bolt.
4. Remove the electrode adjustment gauge.

NOTE: Be sure not to over-tighten the retaining clamp bolt when readjusting the ignition electrodes. Over-tightening the retaining clamp bolt will bend the retaining clamp and prevent the photo disc from floating freely. Not allowing the photo disc to float freely will cause poor combustion, and result in a smoky exhaust. A bent retaining clamp can be re-straightened with a punch and a hammer. Lay the clamp's beveled side down on a solid flat surface and align the thick end of the punch at dead center. Tap the punch lightly until the retaining clamp returns to proper form.

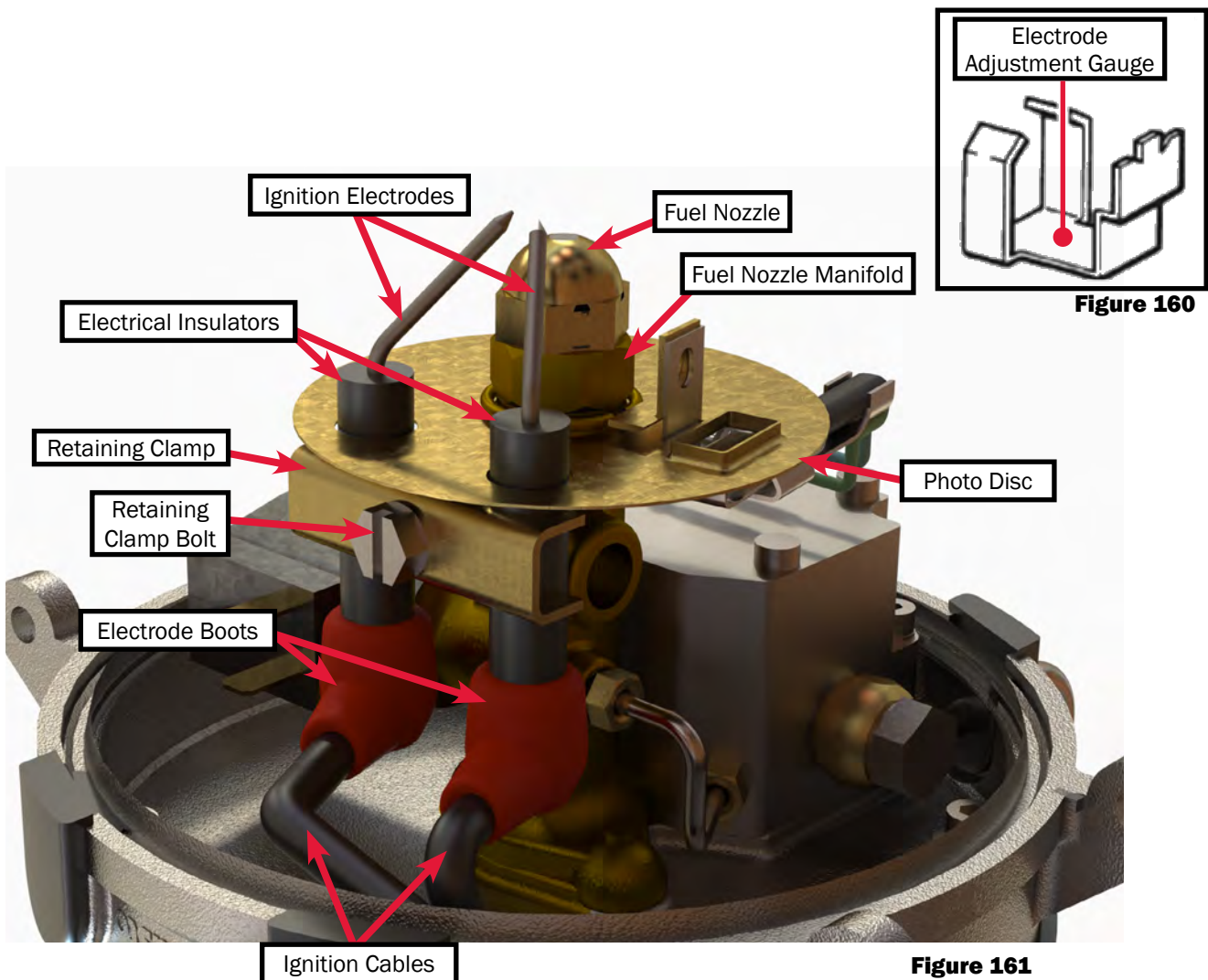

Step 11: Inspect the Photo Disc

1. If the photo disc is not free-floating, the electrode clamp bolt has been over-tightened, and has bent the electrode clamp. Using a 10mm socket, remove the electrode clamp and re-straighten.
 - Lay the clamp's beveled side down on a solid flat surface and align the thick end of the punch at dead center. Tap the punch lightly until the retaining clamp returns to proper form.

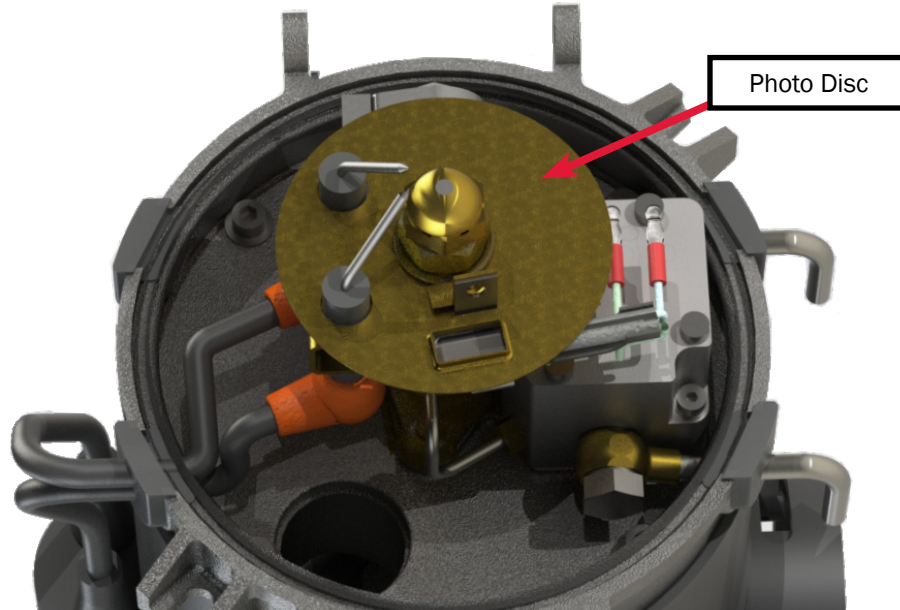

Figure 162

Step 12: Reinstall the Diesel Burner

NOTE: When reinstalling the diesel burner, be careful not to damage the photo disc or bend the electrodes. Also, be careful not to pinch any wires between the burner and the Aqua-Hot boiler tank.

1. Align the diesel burner with the Aqua-Hot, using the alignment tabs welded on the Aqua-Hot.
2. Swing the eye-bolts around the “Ears” on the diesel burner and securely tighten, using a 10mm socket with a 10in long extension.

Use extreme caution when tightening down the eye-bolt nuts. Over-tightening of the eye-bolt nuts can cause the aluminum blower casing to crack.
Torque Specifications: Approximately 20-40 in-Lbs.

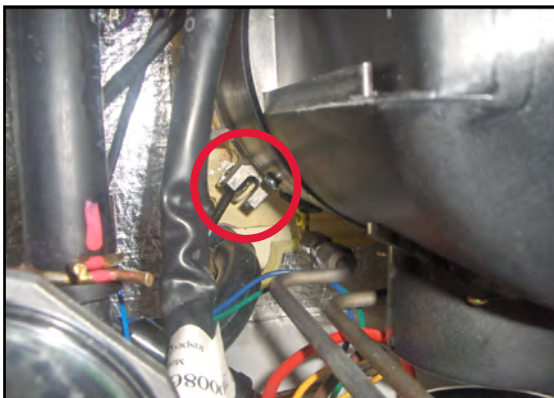

Figure 163

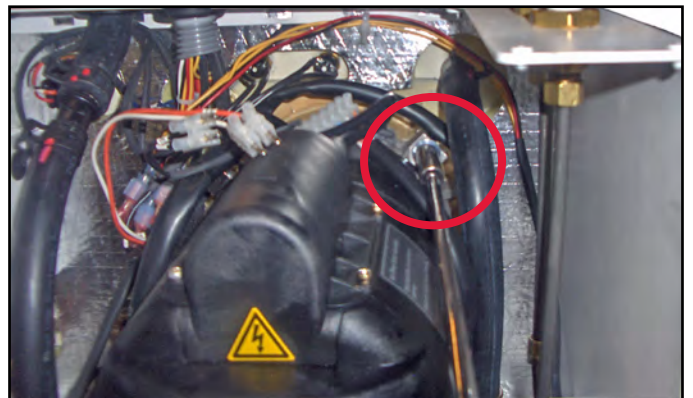

Figure 164

Step 13: Reconnect the Fuel Lines

1. Align the fuel lines on the diesel burner with the fittings on the Aqua-Hot. Using a $\frac{7}{16}$ " wrench, tighten down both the supply and return fuel fittings.

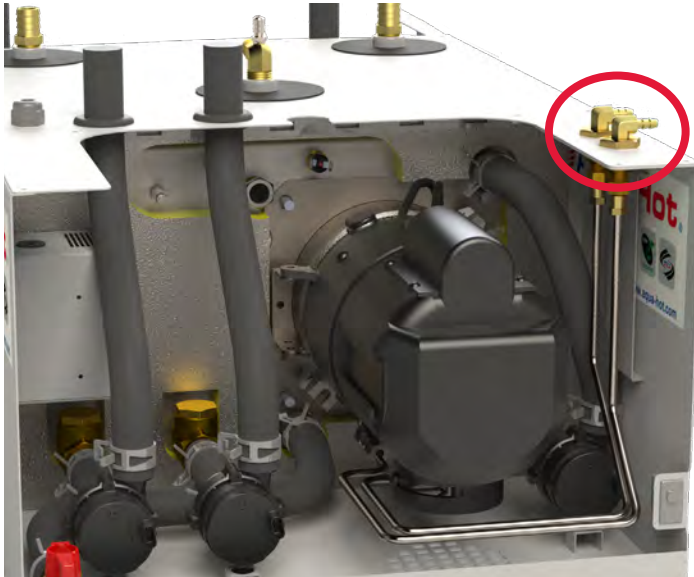

Figure 165

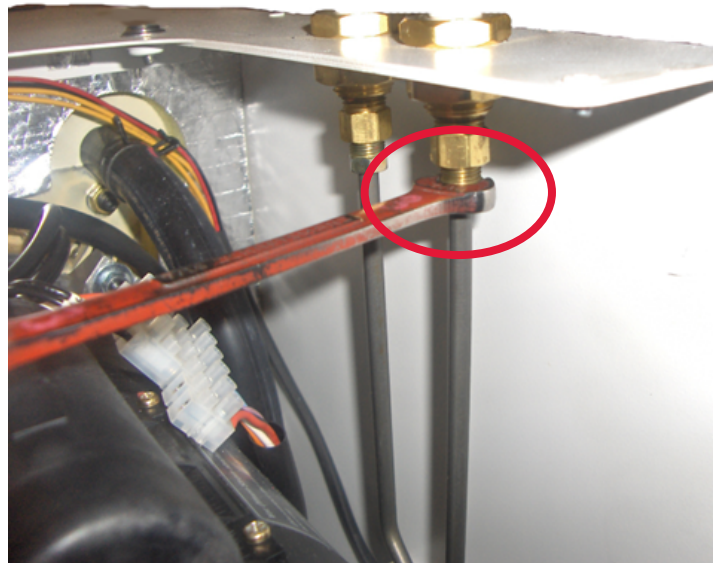

Figure 166

CAUTION

Be sure to remove the clamps off of the fuel supply and return lines at the ports on top of the Aqua-Hot prior to starting the diesel burner or serious damage will occur to the diesel burner's fuel pump.

Step 14: Plug in the Diesel Burner's Controller and Mount

1. Locate the diesel burner's controller and connect both plugs.

NOTE: The diesel burner's controller might have to be mounted onto the side of the diesel burner before the plugs are inserted into the controller, otherwise it might not be possible to mount the controller.

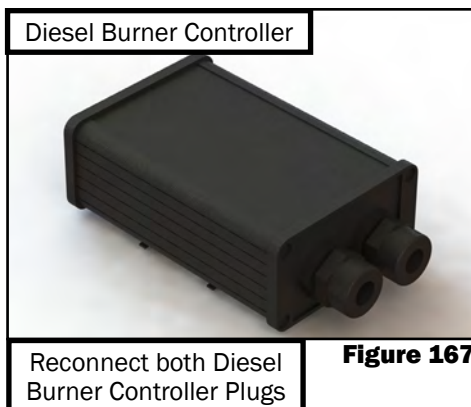

Figure 167

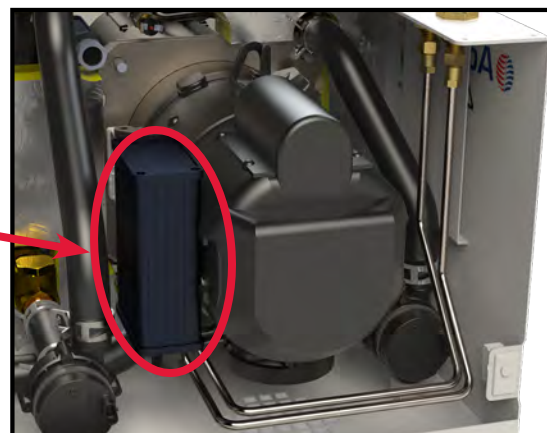

Figure 168

Step 15: Reinstall the Aqua-Hot's Access Cover

1. Reinstall the Aqua-Hot's access cover.

NOTE: The access cover must be installed prior to operation as a safety switch (interlock) exists. It will prevent the Aqua-Hot from operating whenever the access cover is not properly installed.

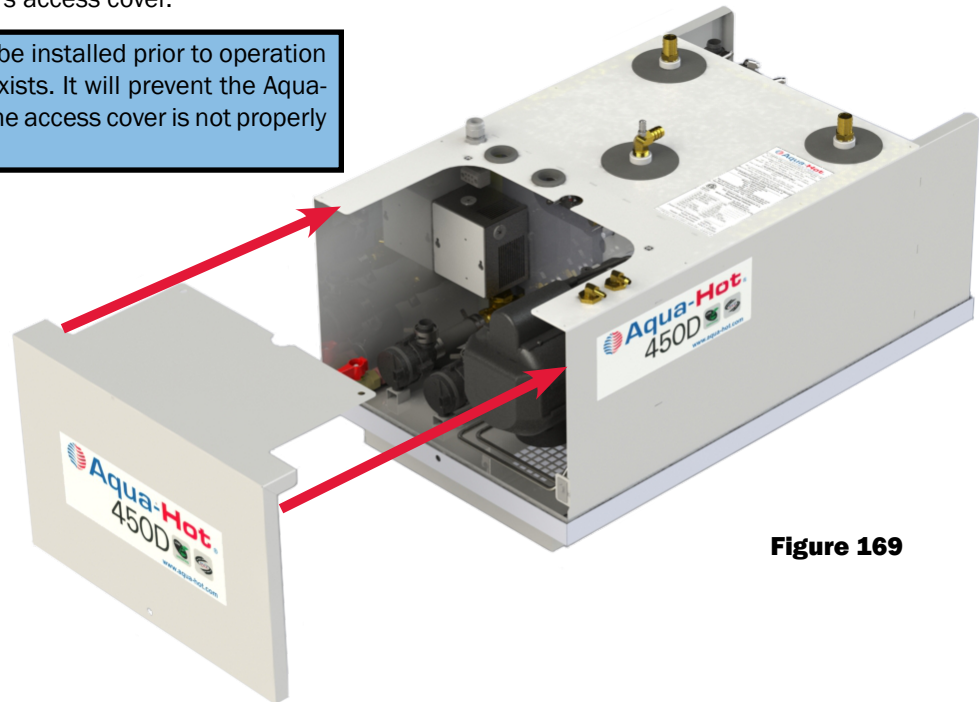

Figure 169

2. Securely tighten the three bolts securing the access cover in place.

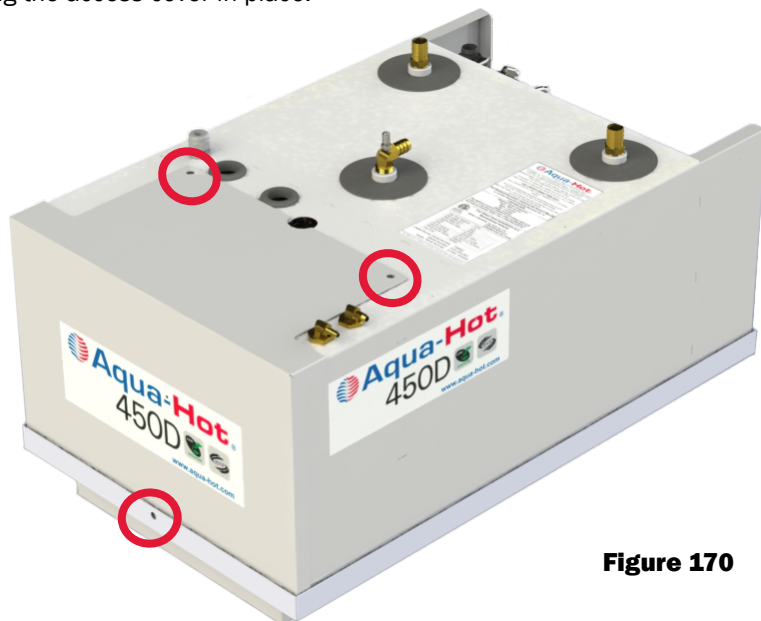

Figure 170

Step 16: Test for Normal Operation

1. Turn the diesel burner ON and allow the diesel burner to run for a complete cycle, until it shuts off on its own.
2. After the diesel burner has shut off, turn on the interior heat or run hot water until the diesel burner cycles back on. When the diesel burner cycles back on, check the exhaust for any signs of smoke.

Winterizing the Aqua-Hot

The Aqua-Hot's domestic water heating system must be completely drained of domestic water at any time the heater is stored where freezing temperatures may be experienced.

Please follow these instructions when winterizing the Aqua-Hot domestic water heating system. Reference Figure 171 for a system overview.

NOTE: The Aqua-Hot can continue to be used for interior heat once the domestic hot water system has been winterized.

1. Completely drain the fresh water storage tank.
2. Disconnect the domestic water demand pump suction line from the fresh water storage tank.
3. Attach an adequate piece of hose onto the suction side of the domestic water demand pump.
4. Place the opposite end of the hose into an adequate supply of non-toxic RV winterization antifreeze (FDA certified as "GRAS" Generally Recognized As Safe must be used) and allow the fluid to pump through.
5. Open and close all interior and exterior water faucets one at a time, until ONLY pure RV antifreeze is present. Perform this procedure for both cold and hot water faucets.
6. Remove the hose and reconnect the domestic water demand pump's suction line to the fresh water storage tank.



WARNING

Not winterizing the Aqua-Hot when freezing temperatures are present will result in SERIOUS damage to the Aqua-Hot domestic water heating system. Ensure that only non-toxic RV antifreeze (FDA approved "GRAS" antifreeze) rated for winterization is used when winterizing this unit. The warranty does not cover freeze damage.

De-Winterization

To de-winterize the Aqua-Hot system, completely fill the fresh water storage tank. Open and close the interior and exterior faucets, one at a time, until only clear water is present.

NOTICE

Disinfecting the Domestic Water System

The Aqua-Hot Heating systems contain copper tubing and are not compatible to prolonged exposure to sodium hypochlorite (bleach or liquid bleach). Using products containing bleach, including water refreshers, may cause corrosion of the domestic water lines, resulting in a catastrophic failure of the Aqua-Hot system by creating leaks that cannot be repaired. This damage is not covered by the Aqua-Hot warranty.

If disinfecting the hot water system, be sure to follow NFPA 1192 Standard on Recreational Vehicles "Instructions for Disinfection of Potable Water Systems" or any other applicable local standards for Potable Water Systems.

NOTE: Extended exposure to household bleach will corrode the components of the Aqua-Hot will potentially dramatically shorten the operational lifetime of the Aqua-Hot. Under no circumstances is the Aqua-Hot to be exposed to household bleach for extended periods of time.

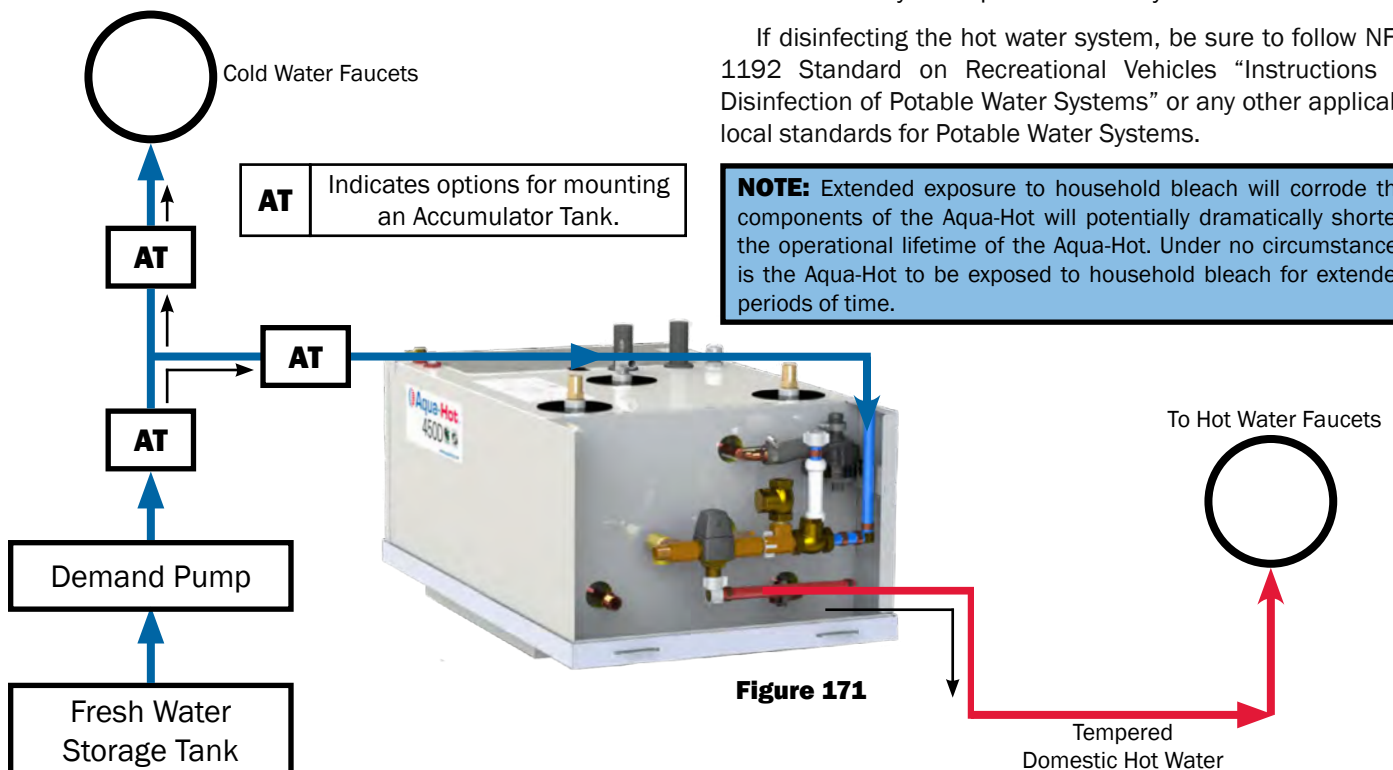

Figure 171

Filling the Aqua-Hot

In order to provide the best freeze protection, boil-over protection, anti-corrosion, and rust protection, a mixture of 50/50 propylene glycol antifreeze and distilled water is recommended. The Aqua-Hot 450D boiler tank holds approximately 5 gallons.

Be sure to use a “GRAS” (Generally Recognized As Safe) boiler-type **propylene glycol** based antifreeze, rather than a RV and Marine antifreeze or an automotive antifreeze/coolant. Reference the Owner’s manual for additional information regarding the antifreeze and water heating solution.

The mixture may be modified to provide the most adequate freezing, boiling, and rust/anti-corrosive protection. A 50/50 mixture of propylene glycol and distilled water has a freeze point of approximately -34°C (-29°F) and a boiling point of approximately 106°C (223°F).

Fill Instructions:

1. Locate the following items:
 - Exterior fluid pump (a diagram pump if possible)
 - The Aqua-Hot fluid expansion tank
 - A bucket or pale
2. Fill the bucket with the heating solution. Ensure the fluid expansion tank is connected to its port on the Aqua-Hot.
3. Open the Aqua-Hot’s drain valve located at the front of the heater. Reference Figure 173.

NOTE: The Aqua-Hot’s boiler tank must be filled with the antifreeze and water heating solution through the drain valve, not through the top of the unit, to avoid air traps.

4. Connect the external fluid fill pump to the fluid drain valve. A ½” NPT barbed fitting is best for this task.
5. Place the supply line of the external pump in the receptacle that contains the heating solution.
6. Locate the Reporter, and navigate to the “INPUTS FROM AQUA-HOT” page.
7. Pay attention to the “LOW LEVEL SENSOR” item on this page.

INPUTS FROM AQUA-HOT				5
BURNER STATUS	LOW LEVEL SENSOR	LOW TEMP SENSOR	COOLANT TEMP	
OFF	TANK FULL	INTERIOR HEAT	190 F	
PREVIOUS				
HOME	FAULTS	DIAG	TEST	

Figure 172

8. Fill the tank to approximately ¾ full, or until the “LOW LEVEL SENSOR” item displays “TANK FULL”, approximately four gallons.
9. Once the tank is partially full, deactivate the external fluid fill pump and close the drain valve. DO NOT disconnect the fluid pump.
10. Proceed to the next page to purge the zone before attempting to start the unit.

NOTE: Do not fill this unit completely. Filling the unit completely runs the risk of air-locking, preventing the heating zone from correctly circulating and draining the air.

! CAUTION

Only propylene glycol based “boiler” type antifreeze deemed “GRAS” (Generally Recognized As Safe) by the FDA shall be used in the Aqua-Hot’s hydronic heating system. Failure to use the above specified antifreeze type could result in serious injury or death.

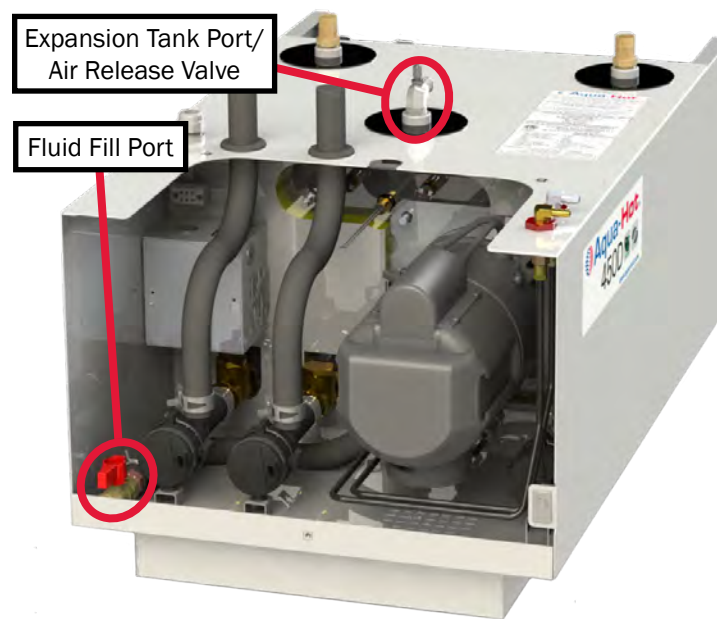

Figure 173

Purging the Interior Heating Loop

In order to provide interior heat to the vehicle, antifreeze and water heating solution is circulated within an interior “heating loop” which distributes heat throughout the coach. During installation or service, it is possible that air may become trapped within the heating loop and hamper unit performance.

Follow this procedure to purge any air from the interior heating loop.

Please note that if an RV-C or multiplex system is used in lieu of the Aqua-Hot display, you must contact the manufacturer, or connect a display to the on-board RV-C network to perform this procedure.

Purge Procedure:

1. Locate the fluid expansion tank of the Aqua-Hot. As any air is purged, it will exit through to this expansion tank.
2. Locate a gallon of glycol antifreeze. This will be used to top-off the fluid expansion bottle as air is purged from the system.
3. Navigate to the “PUMPS” page of the “TESTING” section on the Reporter as displayed below.

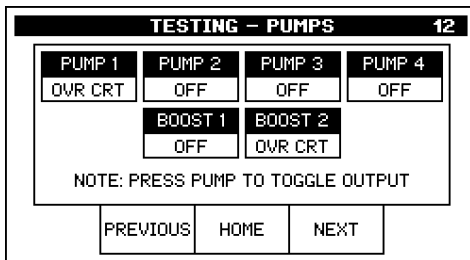

Figure 174

4. Tap each of the pumps to independently activate them, beginning the heating loop purge procedure. These pumps will remain active for a maximum of 5 minutes. They will need to be reactivated as needed until the purge procedure is complete (at least 20 minutes).
5. Continue to fill the unit as air is purged from the interior heating loop.
6. Once the air is no longer returned from the heating zone return ports, deactivate the fluid circulation pumps.
7. Open the fluid drain valve, and activate the external fluid fill pump. Fill the unit with GRAS propylene glycol antifreeze and water heating solution until it reaches the “COLD” mark on the fluid expansion tank.

Draining the Aqua-Hot

NOTE: The Aqua-Hot 450D tank holds approximately five gallons of the antifreeze and water heating solution.

Drain Procedure:

1. Connect a piece of ½” PEX-type tubing or rubber hose to the drain valve. This piece should be long enough to transport the antifreeze and water heating solution from the Aqua-Hot to a bucket.
2. Open the Aqua-Hot’s drain valve located at the front of the heater. See Figure 173.

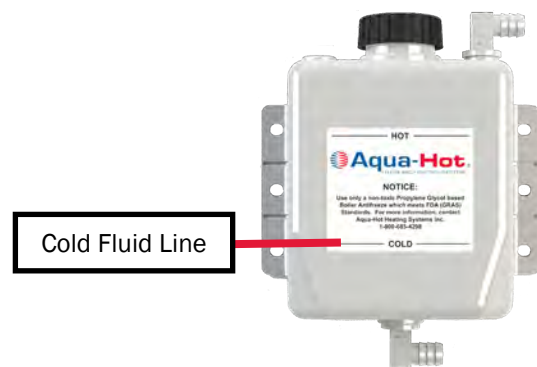

Figure 175

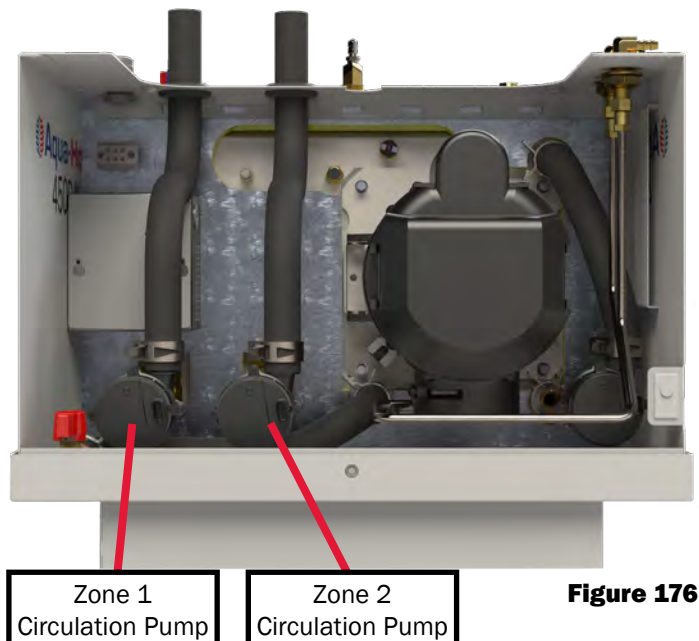
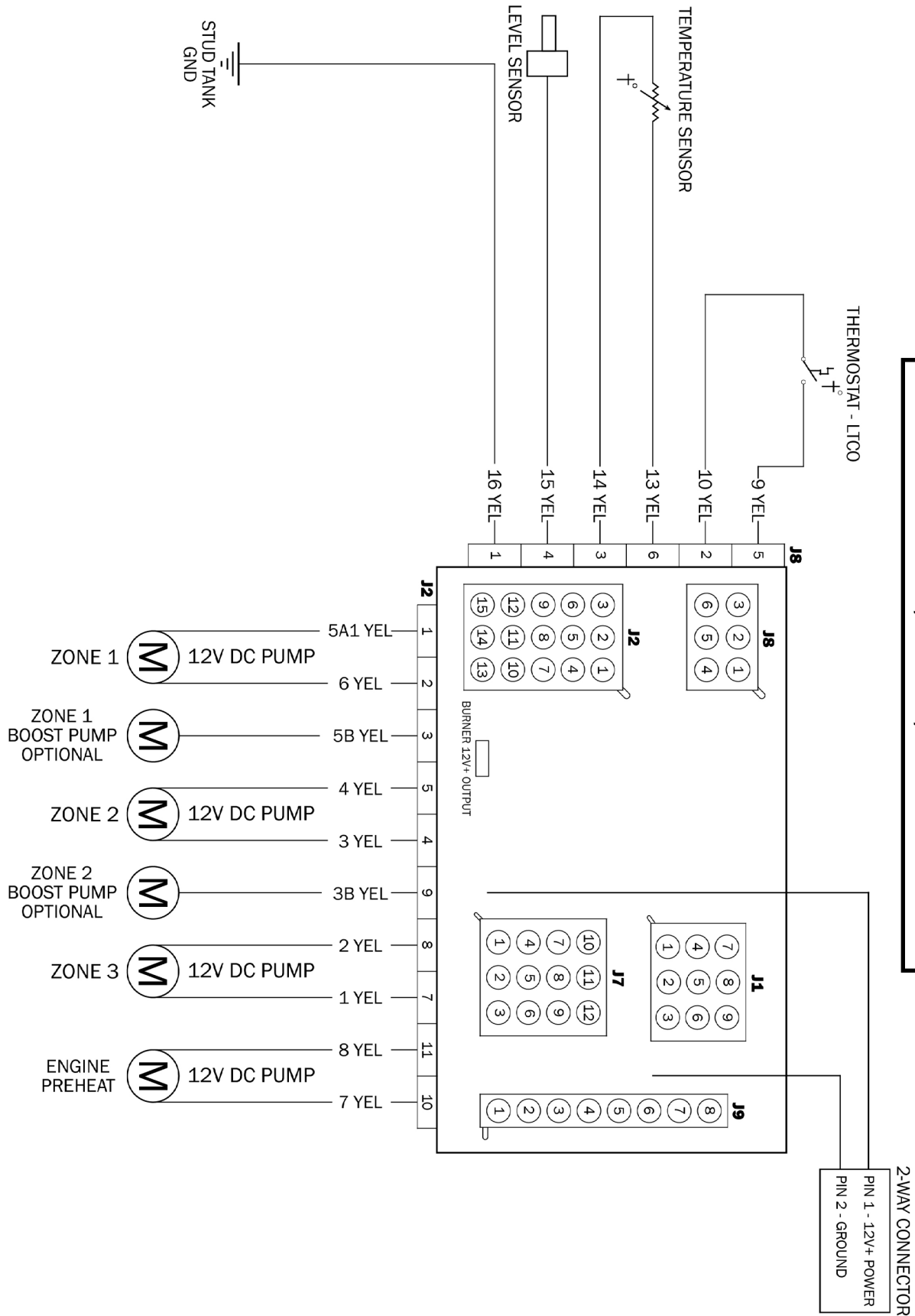
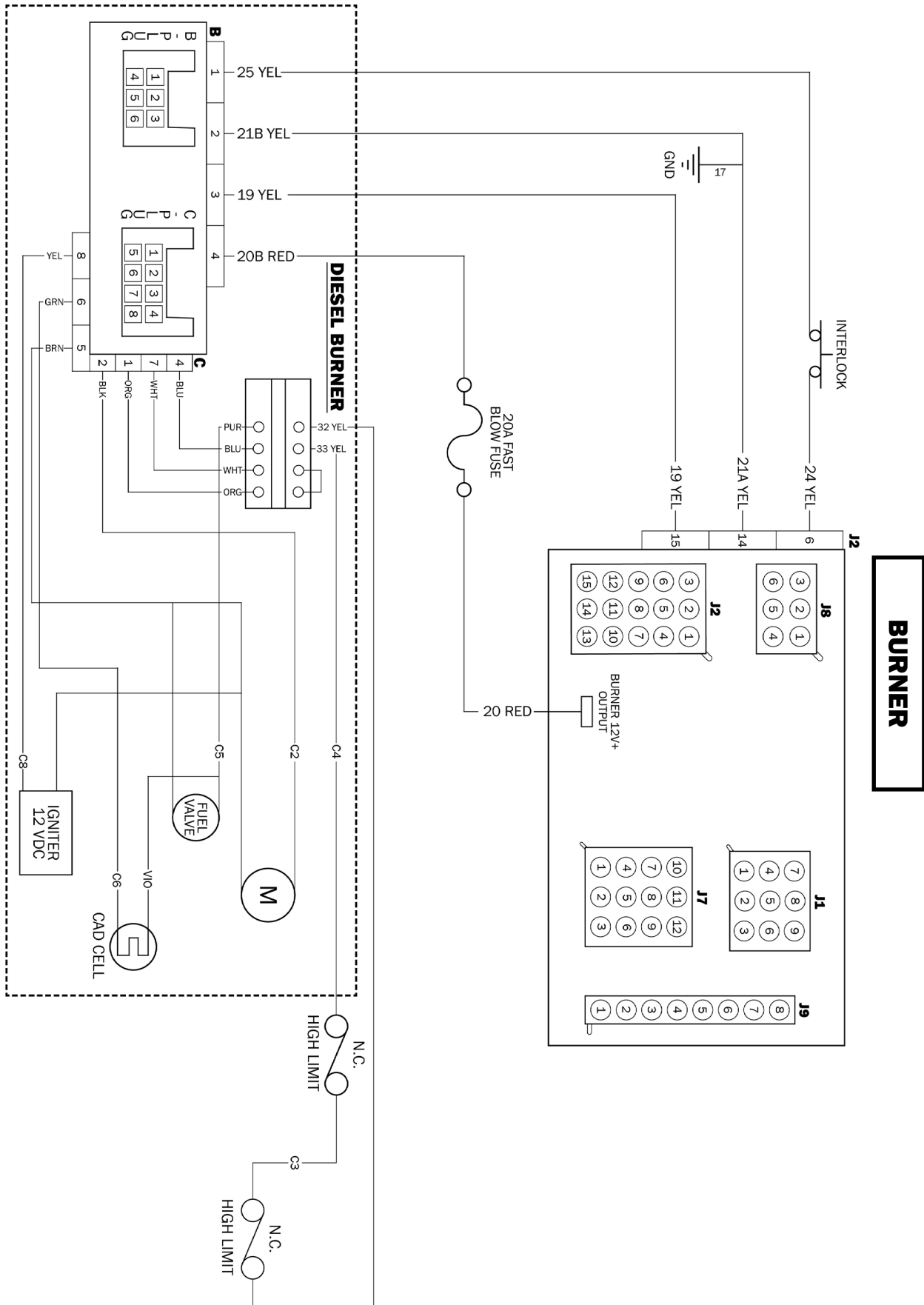

Figure 176

POWER INPUTS, PUMPS, AND SAFETIES





ELECTRIC ELEMENT AND HIGH-LIMIT THERMOSTATS

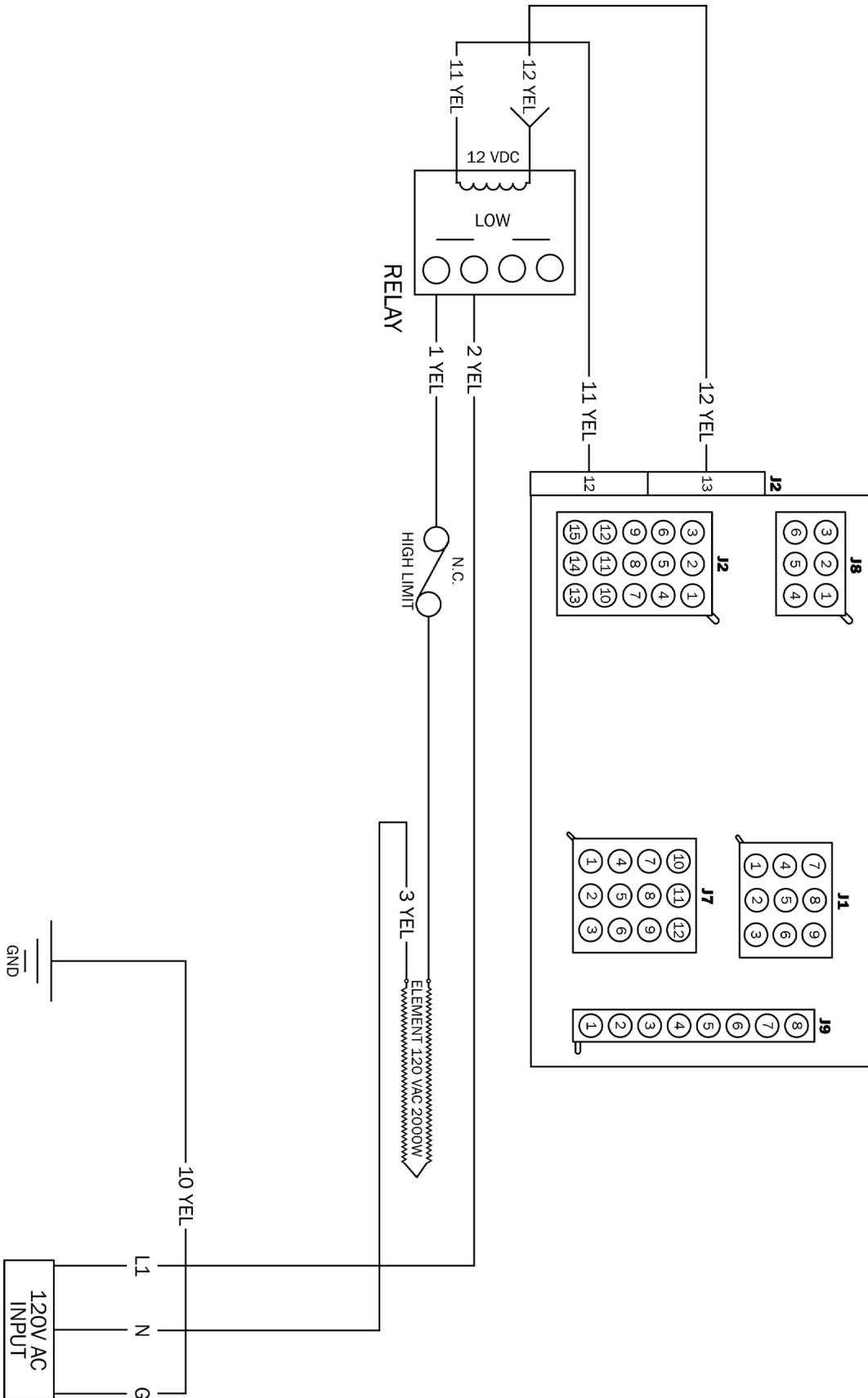

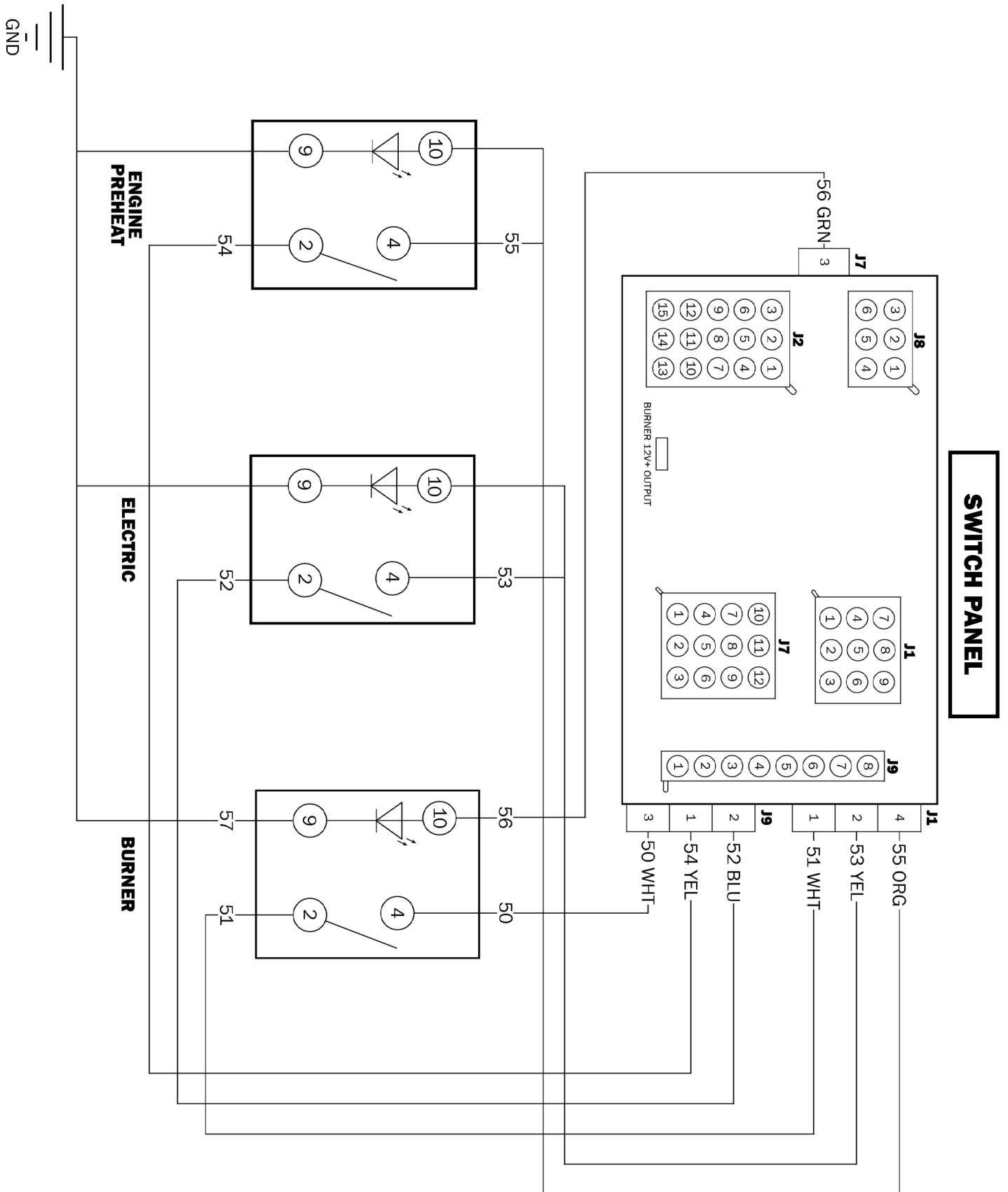

HEAT EXCHANGERS

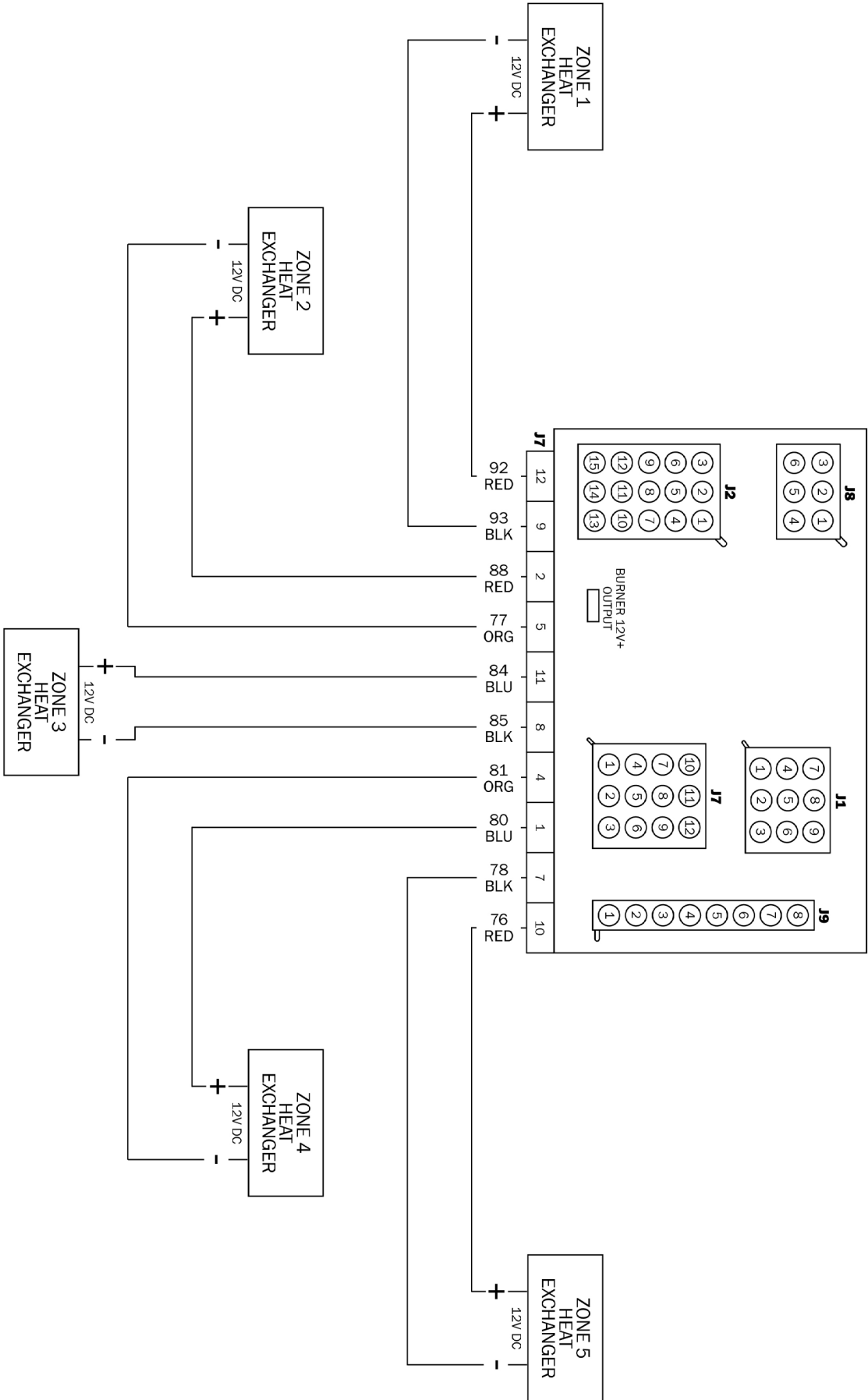

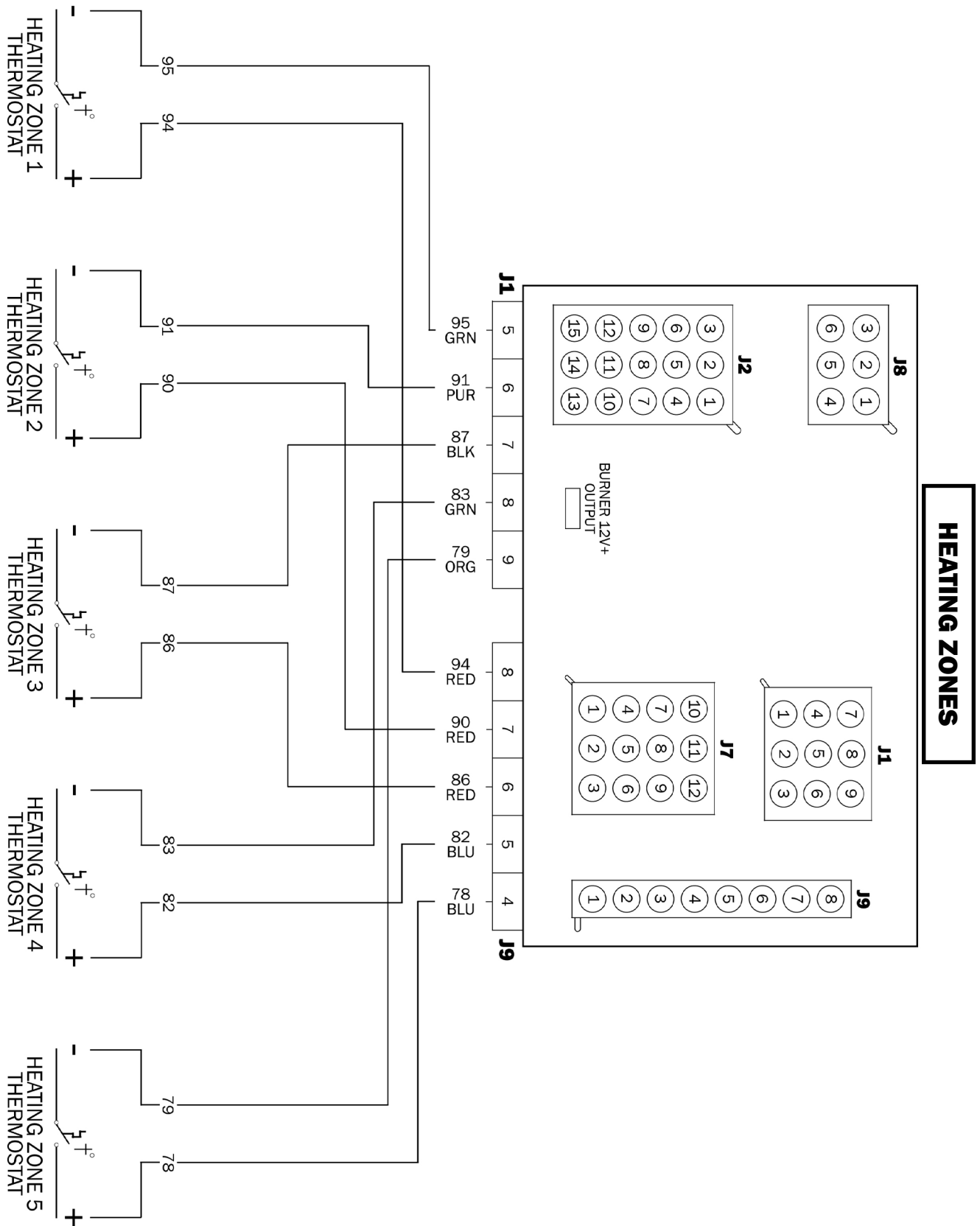



AQUA-HOT™ (2) YEAR LIMITED WARRANTY

Aqua-Hot Heating Systems Inc. warrants the AQUA-HOT heater to the original owner to be free from defects in material and workmanship under normal conditions of designed usage and service as outlined in the installation and operator manuals for a period of two (2) years covering both parts and labor beginning on the date of purchase of the vehicle by the original owner. Replacement parts are covered for the remainder of the heating systems warranty. All purchased replacement parts will carry a six months, (180) days warranty.

This warranty does not apply to scheduled maintenances items such as fuel filters and fuel nozzles, damage or failure of the AQUA-HOT heater or the vehicle into which it was installed due to improper installation, assembly, maintenance, abuse, neglect, accident, or the use of parts not supplied by Aqua-Hot Heating Systems, Inc. Aqua-Hot Heating Systems is not responsible for incidental or consequential damages.

The intent of this warranty is to protect the end user of the heating system from such defects, which might have occurred in the manufacture of the product. The warranty is not intended to protect the end user from problems, which are outside the ability of Aqua-Hot Heating Systems control.

To obtain a warranty repair authorization or information, please contact the Tech Support Department at 1-800-685-4298 (7:00am to 4:00pm Mountain Standard Time).

My Comfort Zones are On-Board

Vehicle:

Purchased From:

Dealer Information:

Name:

Location:

Phone Number:

Heating System:

Serial Number:



Scan the QR code on the right with your mobile device to take you to the website to register your Aqua-Hot product.

Service Manual

400_{SERIES}

 Aqua-Hot®

An AIRXCEL Brand



Aqua-Hot Heating Systems, LLC
7501 Miller Drive, Frederick, CO 80504

Visit us online at www.aquahot.com
Call us at (800) 685-4298

©2023 Aqua-Hot Heating Systems, LLC. Printed in the USA