



**By Vehicle Systems, Inc.**

*Motor Coach Heating Specialists*

## **OWNER'S MANUAL**

**Model Number**

**AHE-100-04S - 12 VDC.**

**AHE-130-04X - 12 VDC.**

# OWNER'S INFORMATION

Owner's Name: \_\_\_\_\_

Address: \_\_\_\_\_

City: \_\_\_\_\_ State: \_\_\_\_\_ Zip Code: \_\_\_\_\_

Telephone: \_\_\_\_\_

E-mail Address: \_\_\_\_\_

Motorhome Model: \_\_\_\_\_

Date of Purchase (Motorhome): \_\_\_\_\_

Aqua-Hot Model No. (reference Figure 1 "Marking Plate"): \_\_\_\_\_

Aqua-Hot Serial No. (reference Figure 1 "Marking Plate"): \_\_\_\_\_

**Please Mail To: Vehicle Systems' Warranty Department  
15549 East Highway 52  
Ft. Lupton, CO 80621**

CUT HERE AND MAIL IN

\_\_\_\_\_  
\_\_\_\_\_  
\_\_\_\_\_  
\_\_\_\_\_

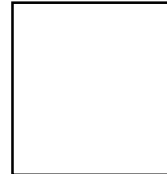

**Vehicle Systems, Inc.  
Warranty Department  
15549 East Highway 52  
Ft. Lupton, CO 80621**

# TABLE OF CONTENTS

<b>Section 1</b>	<b>Overview</b>	<b>Page</b>
	1.0 Aqua-Hot Overview .....	1
	1.1 Marking Plate .....	2
	1.2 Aqua-Hot Model Differentiation.....	3
<b>Section 2</b>	<b>Activating the Aqua-Hot Heating Systems' Heat Sources</b>	
	2.1 Diesel-Burner .....	3
	2.2 Electric Heating Element AHE-100-04S Model .....	4
	2.3 Electric Heating Element(s) AHE-130-04X Model.....	4
<b>Section 3</b>	<b>Operating Instructions</b>	
	3.1 Zone Thermostat(s) Operation.....	5
	3.2 Using the Domestic Hot Water System.....	6
	3.3 Using the Engine Preheat System.....	6
	3.4 Diesel-Burner Component Overview .....	7
	3.5 Diesel-Burner Operational Flow Chart .....	7
	3.6 Precautions .....	8
<b>Section 4</b>	<b>Maintenance</b>	
	4.1 Maintenance Schedule.....	9
<b>Section 5</b>	<b>Winterization</b>	
	5.1 Domestic Hot Water System.....	10
<b>Section 6</b>	<b>Troubleshooting</b>	
	6.1 General Information.....	11
	6.2 Electronic Controller Diagnostic.....	11
<b>Referenced Illustrations</b>		
	Figure 1: Aqua-Hot Hydronic Heating System and Inclusive Components.....	2
	Figure 2: Marking Plate .....	2
	Figure 3: Aqua-Hot Interior Switch Panel .....	6
	Figure 4: Diesel-Burner Components.....	7
	Figure 5: Diesel-Burner Components Requiring Annual Maintenance .....	9
	Figure 6: Electronic Controller .....	11

## SECTION 1: OVERVIEW

### Aqua-Hot Overview

#### 1.0 Aqua-Hot Overview

---

The Aqua-Hot Heating System is an on-board Hydronic Heating System (heating with hot water) that provides a continuous, on-demand supply of domestic hot water, as well as interior zone heating where and when it is needed. Both heating features are accomplished by a unique 12 Volt-DC Powered Diesel-Fired Burner and a minimum of one 120 Volt-AC Powered Electric Heating Element. (As the number of Electric Elements will vary between Aqua-Hot models, please reference page 5 to determine the particular model of Aqua-Hot employed.) These two heating sources maintain the temperature of the Aqua-Hot's solution of water and antifreeze. In addition, the Aqua-Hot has been designed to preheat the vehicle's engine prior to starting. This preheat feature provides an easy engine start-up whenever cool weather conditions are present. Be sure to review **Figure 1** for a complete component overview.

## SECTION 1: OVERVIEW

### Aqua-Hot Overview, continued

**NOTE:** This Aqua-Hot product utilizes an FDA approved GRAS Propylene Glycol (P.G.) based water and antifreeze solution. This P.G. based solution is a Boiler type anti-freeze, which is Generally Recognized as Safe ("GRAS") by the FDA. For additional information regarding this GRAS antifreeze product, please contact the Technical Support Department at 1-800-685-4298 or visit the website at [www.vehiclesys.com](http://www.vehiclesys.com).

# SECTION 1: OVERVIEW

## Aqua-Hot Overview, continued

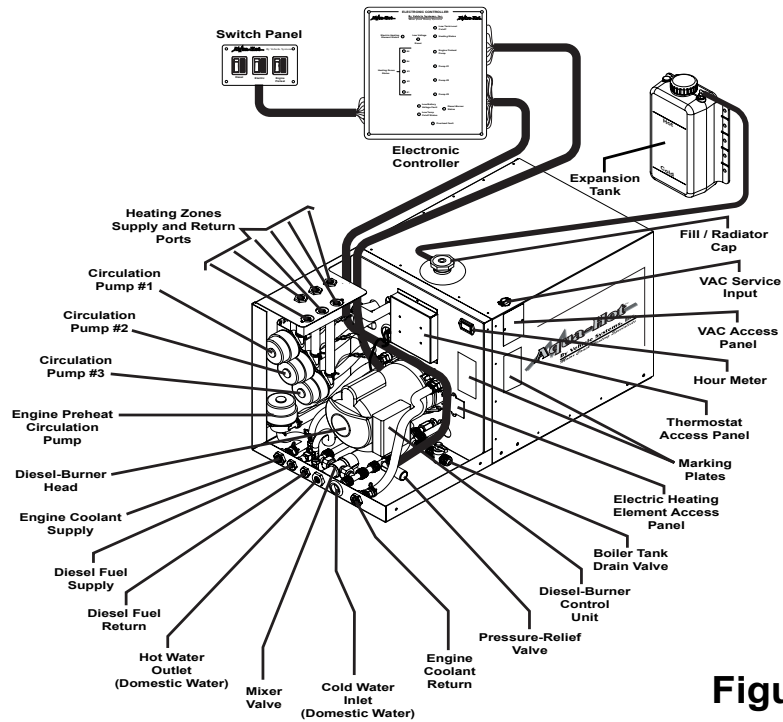

Figure 1

# SECTION 1: OVERVIEW

## Marking Plate

### 1.1 Marking Plate

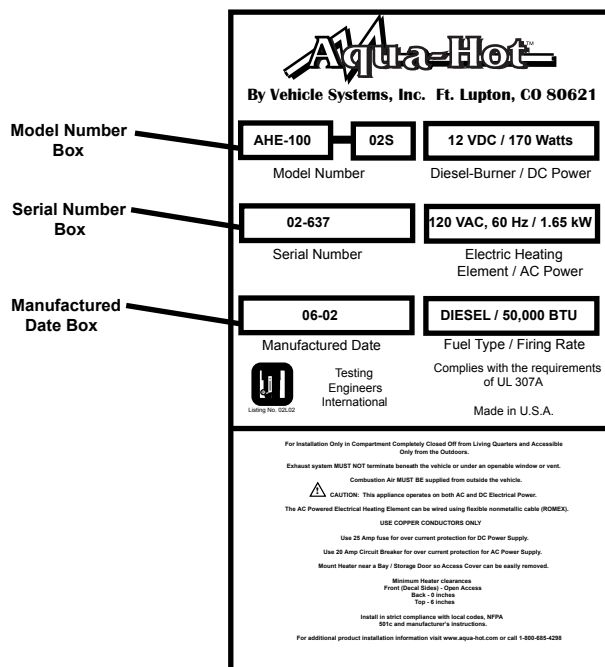

Figure 2

## SECTION 1: OVERVIEW

### Aqua-Hot Models

#### 1.2 Aqua-Hot Model Differentiation

---

Vehicle Systems, Inc. manufactures two individual models of the Aqua-Hot Hydronic Heating System. The varying factor between the two models is the number of Electric Heating Elements featured. In order to determine which of the following Aqua-Hot models has been employed, locate the Marking Plate on the Heating System (reference Figures 1 and 2 for Marking Plate information) and view the model number.

##### **AHE-100-04S:**

This model features a single 120 VAC/1650 Watt Electric Heating Element. Reference page 7 for operating instructions.

##### **AHE-130-04X:**

This model features two 120 VAC/2000 Watt Electric Heating Elements. Reference page 8 for operating instructions.

## SECTION 2: ACTIVATING THE AQUA-HOT'S HEAT SOURCES

### Diesel-Burner Operation

Please read the complete Owner's Manual prior to operating your Aqua-Hot Heating System. Also, be sure to fill out and mail in your Owner's Information Card located at the front of this manual.

#### 2.1 Activating the Diesel-Burner

---

##### **Diesel-Burner**

Turn the **Diesel** switch **ON**; reference **Figure 3**. This procedure will activate the Diesel-Burner and the indicator light located on the Diesel switch. Allow 10-20 minutes for the Aqua-Hot System to reach operating temperature. Please note that the Diesel-Burner is the **primary heat source** for heating both the interior and the domestic hot water (such as when cool ambient temperatures exist and/or when there is a high demand for domestic hot water).

**NOTE:** The "Diesel" switch can also be used to reset a 12 Volt-DC Low Voltage Fault. Please reference Section 6.

## SECTION 2: ACTIVATING THE AQUA-HOT'S HEAT SOURCES

### Electric Element Operation AHE-100-04S

#### 2.2 Activating the Electric Heating Element for the AHE-100-04S Model

##### Electric Heating Element

Turn the **Electric** switch **ON**; reference **Figure 3**. This procedure will activate the 120 VAC Electric Heating Element and the indicator light located on the Electric switch. Allow 1-2 hours for the Aqua-Hot System to reach operating temperature. Please note that the Electric Heating Element is a **secondary heat source** for heating both the interior and the domestic hot water during low heating demand situations (such as when moderate ambient temperatures exist and/or when there is a low demand for domestic hot water).

**NOTE:** Both the Diesel-Burner and the Electric Heating Element are thermostatically controlled. Either, or both, heating sources will automatically maintain the temperature of the Aqua-Hot's water and antifreeze solution between approximately 160-190 (+/- 5) degrees Fahrenheit. To heat your motorhome / domestic hot water, simply choose the desired heat source(s) and leave the switch(s) (i.e., Diesel and/or Electric) **ON**.

## SECTION 2: ACTIVATING THE AQUA-HOT'S HEAT SOURCES

### Electric Element Operation AHE-130-04X

#### 2.3 Activating the Electric Heating Element(s) for the AHE-130-04X Model

##### Electric Heating Element(s)

###### Low:

Turn the **Electric** switch **ON** in conjunction with the High / Low switch placed in the **LOW** position; reference **Figure 3**. This procedure will activate one of the two 120 VAC Electric Heating Elements and the indicator lights located on both the Electric and High / Low switches. Allow 1-2 hours for the Aqua-Hot System to reach operating temperature.

###### High:

Turn the **Electric** switch **ON** in conjunction with the High / Low switch placed in the **HIGH** position; reference **Figure 3**. This procedure will activate both of the 120 VAC Electric Heating Elements and the indicator lights located on both the Electric and High / Low switches. Allow 0.5-1 hour for the Aqua-Hot System to reach operating temperature.

**NOTE:** In order to operate both Electric Heating Elements, you will either need a 50-AMP Shore Power electrical source, or your Generator must be capable of producing the necessary VAC electrical power requirements. Please contact the manufacturer of your specific motorhome for information regarding the specifics of your motorhome's electrical system.

## SECTION 3: OPERATING INSTRUCTIONS

### Comfort Control

#### 3.1 Zone Thermostat(s) Operation

---

##### Interior Room Thermostats

Simply adjust each Interior Room Thermostat to the desired temperature. Then, whenever an Interior Room Thermostat “**calls-for-heat,**” the Aqua-Hot’s Circulation Pump(s) and Interior Heat Exchanger Fans will be activated. These devices together will supply warmth and comfort to each interior heating zone. Please contact your specific motorhome manufacturer for the exact location of the Interior Room Thermostat(s).

##### Fresh Water Tank Thermostat

Simply adjust the Thermostat (i.e., Bay Heating) to approximately 40 degrees Fahrenheit. This will prevent freezing of the domestic water storage system. Please contact your specific motorhome manufacturer for the exact location of the Fresh Water Tank Thermostat.

## SECTION 3: OPERATING INSTRUCTIONS

### Hot Water

#### 3.2 Using the Domestic Hot Water System

---

When the Aqua-Hot is at operating temperature, the domestic water is automatically heated as it is being used. Because the Aqua-Hot does not store any hot water, simply open any hot water faucet and a continuous supply of domestic hot water will be present within a few seconds. This hot water feature is **continuous** and is accomplished by the Aqua-Hot’s Domestic Hot Water Heating System. Please note that the **Diesel** switch must be **ON** to get an unlimited supply of hot water (i.e., during showers).

### Engine Preheat

#### 3.3 Using the Engine Preheat System

---

When the Aqua-Hot is at operating temperature and the **Diesel-Burner** and/or the **Electric Heating Element(s)** switch(s) is **ON**, follow these simple instructions:

- A.** Turn the Aqua-Hot’s **Engine Preheat** switch **ON**; reference **Figure 3**. This procedure will activate the Engine Preheat Circulation Pump and circulate the engine’s coolant through the Engine Preheat System. This feature will adequately warm the engine for easy start-ups on cool mornings.

**NOTE:** Allow approximately 1 to 2 hours of engine preheating run time. Preheat duration will be shortest when the **Diesel** switch is **ON**.



## SECTION 3: OPERATING INSTRUCTIONS

### Engine Preheat, continued

- B. Turn **OFF** the Aqua-Hot's **Engine Preheat** switch whenever engine preheating is not desired.

**NOTE:** The Aqua-Hot's Engine Preheating System acts as a **supplemental heating source** in addition to the Diesel-Burner and the Electric Heating Element(s). While traveling, the engine's heated coolant will automatically pass through the Engine Preheat / Motoraide System, transferring heat into the Aqua-Hot's Boiler Tank. This design feature reduces the total operating hours of the Diesel-Burner and the Electric Heating Element(s).

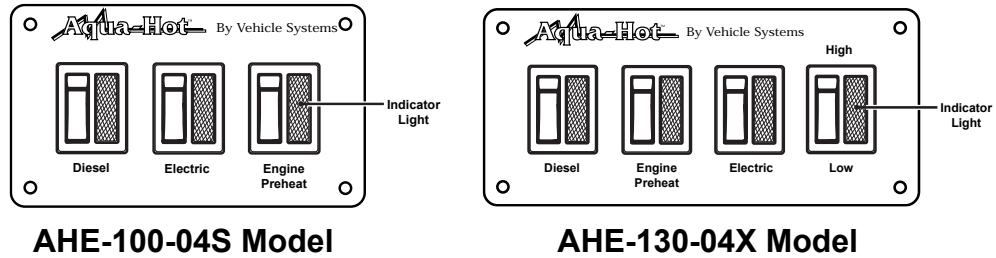

**Figure 3**

## SECTION 3: OPERATING INSTRUCTIONS

### Diesel-Burner Component Overview

#### 3.4 Diesel-Burner Component Overview

- |                          |                        |   |
|--------------------------|------------------------|---|
| 1. Control Unit          | 6. Fuel Solenoid       | 11. Combustion Chamber                                  |
| 2. Motor                 | 7. Electrode Holder    | 12. Exhaust Port  |
| 3. Ignition Coil         | 8. Ignition Electrodes | 13. Flame Sensor  |
| 4. Clutch                | 9. Fuel Nozzle         | 14. Fuel Pump   |
| 5. Combustion Air Blower | 10. Heat Exchanger     | 15. Fuel Ports (Supply / Return)                        |
|                          |                        | 16. Combustion Air Intake Port, with Adjustable Shutter |

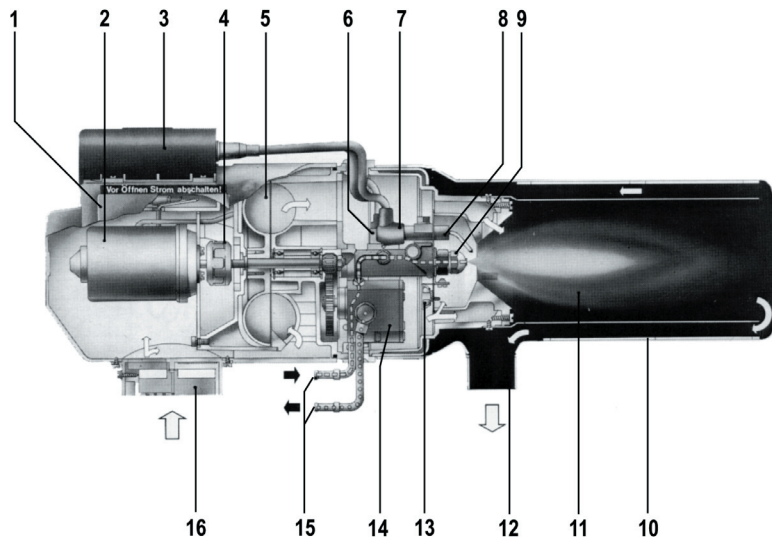

**Figure 4**

## SECTION 3: OPERATING INSTRUCTIONS

### Diesel-Burner Operational Flow-Chart

#### 3.5 Diesel-Burner Operational Flow-Chart

Reference Figure 3 for all numbers indicated inside parentheses. (e.g., #8).

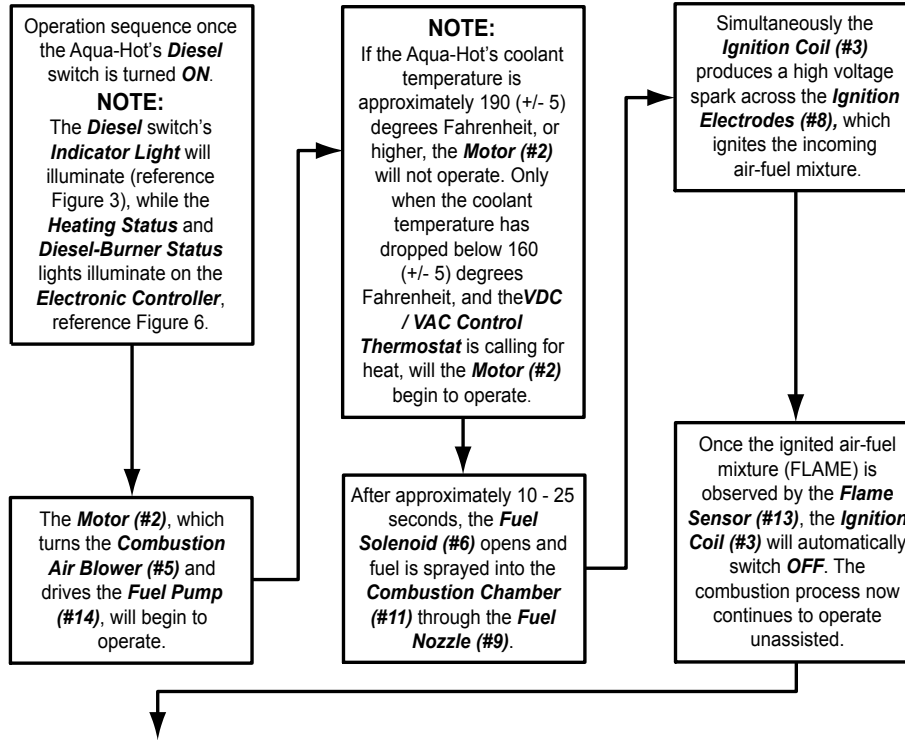

## SECTION 3: OPERATING INSTRUCTIONS

### Diesel-Burner Operational Flow-Chart, continued

#### 3.5 Diesel-Burner Operational Flow-Chart, continued

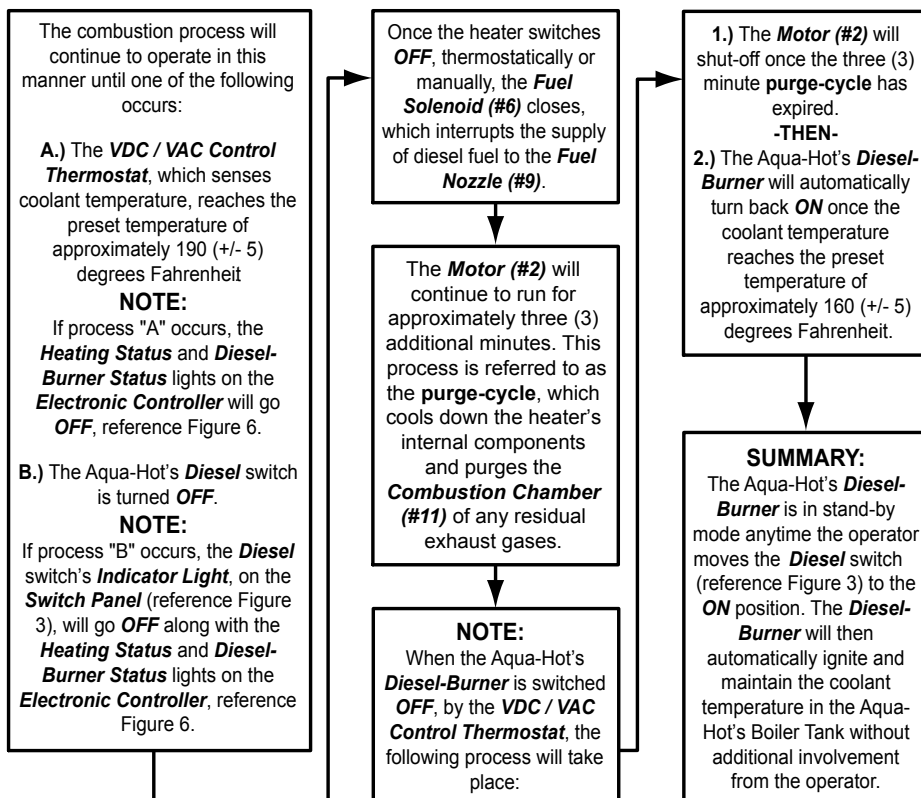

## SECTION 3: OPERATING INSTRUCTIONS

### Important Information



#### 3.6 Precautions

##### WARNINGS:

- **The Aqua-Hot's Exhaust is HOT!**
- **DO NOT** park in areas where dry conditions exist underneath the vehicle, as a fire may result (e.g., in a dry grassy field).
- **DO NOT** operate the Aqua-Hot's Diesel-Fired Burner inside an enclosed building.
- The Heater should be switched **OFF** when refueling.

**CAUTION:** **DO NOT** operate the Diesel-Burner and/or the Electric Heating Element(s) without the water and antifreeze solution in the Aqua-Hot's Boiler Tank. Failure to do so will cause **serious damage** to the Heater.

## SECTION 4: MAINTENANCE

### Upkeep

#### 4.1 Maintenance Schedule

##### Monthly

Check the Aqua-Hot's solution of water and antifreeze to ensure that it is at the proper level. Do this by visually checking the coolant level in the Aqua-Hot's Expansion Tank; reference **Figure 1**. Please note that the coolant level should be checked **only** when the Aqua-Hot is at maximum operating temperature (i.e., when the Diesel-Burner cycles **OFF**), "**HOT.**"



**WARNING:** When the Aqua-Hot is at maximum operating temperature (**HOT**), **DO NOT** loosen the Radiator Cap. If removed, scalding by hot vapor or coolant could result.

**NOTE:** This Aqua-Hot product utilizes a Propylene Glycol (P.G.) based water and antifreeze solution. This P.G. based solution is a Boiler type antifreeze, which is Generally Recognized as Safe ("GRAS") by the FDA. For additional information regarding this GRAS antifreeze product, please contact us at 1-800-685-4298 or visit our website at **[www.vehiclesys.com](http://www.vehiclesys.com)**.

If the coolant needs replenishing, fill the Aqua-Hot's Expansion Tank to the **FULL HOT** level mark. Be sure to use a 50/50 mixture of water and (P.G.) antifreeze.

## SECTION 4: MAINTENANCE

### ■ Upkeep, continued

Annually



**WARNING:** Before cleaning or servicing, disconnect all power supplies.

To keep your Aqua-Hot running smoothly, it is ideal to have the Diesel-Burner tuned-up annually. A tune-up should consist of a new Fuel Nozzle and Fuel Filter, along with a thorough cleaning of the Combustion Chamber, if necessary (reference Figure 5). To ensure maximum Diesel-Burner performance, always use the recommended Fuel Nozzle (i.e., 0.35 GPH) and Fuel Filter (i.e., 10 Micron) when replacing these parts. Reference the Aqua-Hot "Parts Manual" for spare parts information. If detailed replacement instructions are needed, please reference the Aqua-Hot "Shop Manual" or contact the Technical Support Department at 1-800-685-4298 for the nearest Aqua-Hot Service Center.

**CAUTION: DO NOT** operate the Diesel-Burner and/or the Electric Heating Element(s) without the water and antifreeze solution in the Aqua-Hot's Boiler Tank. Failure to do so will cause **serious damage** to the Heater.

**Figure 5**

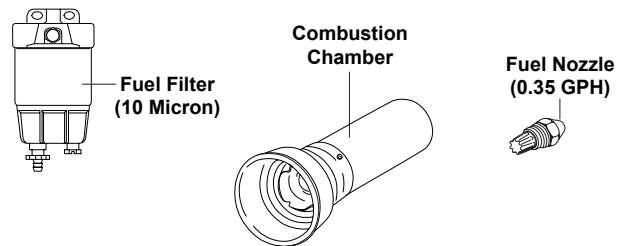

## SECTION 5: WINTERIZATION

### ■ Storage

#### 5.1 Domestic Hot Water System

The Aqua-Hot's Domestic Hot Water Heating System must be completely drained of domestic water any time the heater is stored where freezing temperatures may be experienced.

**CAUTION:** Not winterizing your Aqua-Hot when freezing temperatures are present **will result in serious damage** to the Aqua-Hot's Domestic Hot Water Heating System.

**NOTE:** The Aqua-Hot can still be used for interior zone heating even if the domestic hot water system has been drained and winterized.

Please follow the instructions listed below when winterizing the Aqua-Hot's Domestic Hot Water Heating System:

**A.** Completely drain the fresh water storage tank.

**NOTE:** If your motorhome is equipped with appliances that use fresh water (e.g., ice makers, water purifiers, etc.) follow the manufacturer's recommendation for winterization.

**B.** Disconnect the domestic water demand pump's suction line from the fresh water storage tank.

## SECTION 5: WINTERIZATION

### ■ Storage, continued

- C. Attach an adequate piece of hose onto the suction side of the domestic water demand pump.
- D. Place the opposite end of the hose into an adequate supply of FDA approved RV-Antifreeze.
- E. Open / close all interior and exterior water faucets, one at a time, until only pure RV-Antifreeze is present. Perform this procedure for both the hot and cold faucets.
- F. Remove the hose and reconnect the domestic water demand pump's suction line to the fresh water storage tank.
- G. Disconnect all electrical power supplies to the Aqua-Hot during storage.

**NOTE:** For de-winterization, completely fill the fresh water storage tank. Open / close all interior and exterior water faucets, one at a time, until only clear water is present / visible.

**CAUTION:** If you are disinfecting your potable water system after de-winterizing, be sure to follow RVIA's "**Instruction for Disinfection of Potable Water Systems on Recreation Vehicles.**" These instructions can be found in the ANSI A119.2 Handbook for Recreational Vehicle Standards. To receive a copy of this RVIA Standard, write to: **Recreation Vehicle Industry Association, 1896 Preston White Drive, P.O. Box 2999, Reston, VA 20195-0999** or visit the RVIA website at [www.rvia.com](http://www.rvia.com).

## SECTION 6: TROUBLESHOOTING

### ■ General Information

#### 6.1 General Information

If the Aqua-Hot's Diesel switch "**Indicator Light**" does not illuminate, and the Diesel-Burner is not functioning, locate the Electronic Controller (**Figure 6**) and check the following:

- A. Check the Aqua-Hot's Electronic Controller for any RED lights indicating a fault condition. Reference **Figure 6** and the Electronic Controller Troubleshooting section to identify these fault conditions.
- B. Check for loose wire connections on the Electronic Controller's Terminal Strips/Plugs. When checking for loose Terminal Strips/Plugs, remove the Electronic Controller Faceplate by unscrewing the four cover screws.
- C. Remove the Aqua-Hot's Access Cover and check for loose plug connectors on the Diesel-Burner's Control Unit (located on the under side); reference **Figure 1**.
- D. Check to ensure that the vehicle's fuel tank has a sufficient level of fuel.
- E. If your Aqua-Hot still fails to operate, please contact the **Technical Support Department** at **1-800-685-4298** for additional troubleshooting assistance or visit our website at [www.vehiclesys.com](http://www.vehiclesys.com)

## SECTION 6: TROUBLESHOOTING

### Electronic Controller

#### 6.2 Electronic Controller Diagnostic

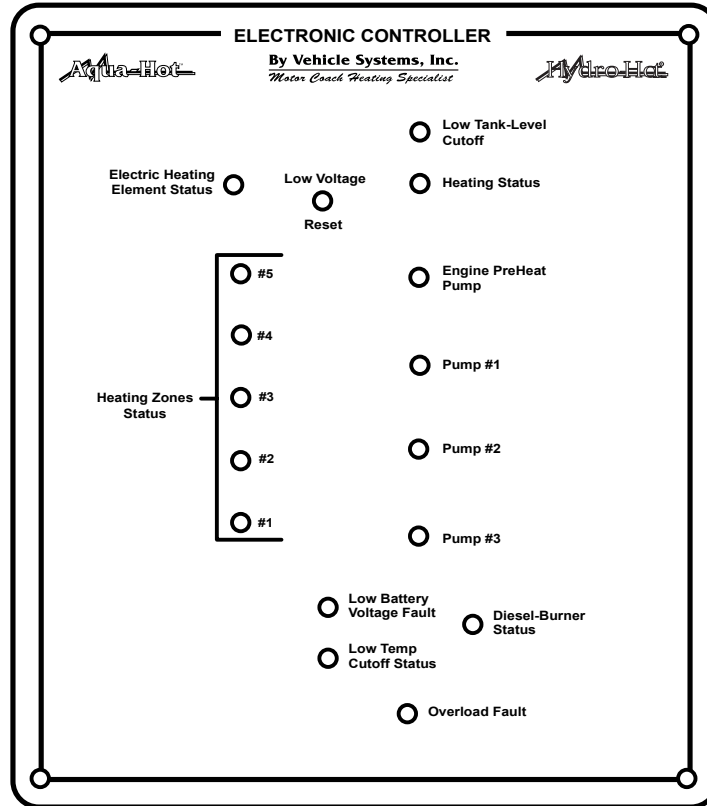

Figure 6

## SECTION 6: TROUBLESHOOTING

### Electronic Controller, continued

#### **Low Tank-Level Cutoff Indicator Light:**

This indicator light will illuminate RED when either the Electric Heating Element(s) and/or Diesel-Burner have automatically shut down due to a low water and antifreeze solution level inside the Aqua-Hot's Boiler Tank. This fault will automatically reset when the low level condition is corrected.

#### **Low Battery Voltage Fault Indicator Light:**

This indicator light will illuminate RED whenever the VDC voltage level is too low for the Aqua-Hot to operate properly. This fault must be manually reset after the voltage level has been restored to the VDC battery system, **reference Low Voltage Reset** below.

#### **Low Voltage Reset (Button):**

The Aqua-Hot's Electronic Controller must be manually reset whenever the Low Battery Voltage Fault indicator light has been activated. The Electronic Controller can be reset either by depressing the "**Low Voltage Reset**" button located on the Electronic Controller (use a thin, straight, nonmetallic object to access the reset button through the small hole in the faceplate) or by turning **OFF** the Diesel switch on the Heater's Interior Switch Panel for approximately 30 seconds, then turning the switch back ON.

#### **Overload Fault Indicator Light:**

This indicator light will illuminate RED whenever one of the following conditions have occurred:

1. The Aqua-Hot is off due to an electrical overload (i.e., short) in the main VDC power supply circuitry.

## SECTION 6: TROUBLESHOOTING

### Electronic Controller, continued

2. The Aqua-Hot is off due to a combination of high electrical VDC power loads and a high surface temperature of the Electronic Controller.

The Aqua-Hot will automatically restart once the electrical overload (i.e., short) and/or high heat condition is corrected.

#### **Heating Zones Status Indicator Lights:**

These five indicator lights (separately) will illuminate GREEN whenever a Zone Thermostat, for each particular zone, is calling for heat. The GREEN indicator lights also indicate that VDC power is being supplied to the particular interior heating zone's Heat Exchangers (i.e., fan motors). If any of the five indicator lights illuminate RED, it indicates that an electrical overload condition (i.e., short) has occurred in a particular heating zone's circuitry.

**NOTE:** A short in either a heating zone's Interior Room Thermostat or heating zone's Heat Exchanger circuit will cause the indicator light to illuminate RED.

#### **Pumps #1, #2, and #3 Indicator Lights:**

These indicator lights (separately) will illuminate GREEN whenever a Circulation Pump is operating. If any of the three indicator lights illuminate RED, it indicates that an electrical overload condition (i.e., short) has occurred in the particular component's circuitry.

**NOTE:** The Zone Circulation Pumps (separately) are activated whenever a Zone Thermostat calls for heat.

## SECTION 6: TROUBLESHOOTING

### Electronic Controller, continued

#### **Engine Preheat Pump Indicator Light:**

This indicator light will illuminate GREEN whenever the Engine Preheat Pump is operating. Please note that this light will only be active if the Engine Preheat switch is **ON** in conjunction with either the Diesel and/or the Electric switch. If this indicator light illuminates RED, it indicates an electrical overload condition (i.e., short) has occurred in this particular component's circuitry.

#### **Heating Status Indicator Light:**

This indicator light will illuminate GREEN whenever the Aqua-Hot's VDC / VAC Control Thermostat is calling for heat, allowing the water and antifreeze solution in the Aqua-Hot's Boiler Tank to be heated by either the Diesel-Burner and/or the Electric Heating Element(s). When this indicator light is off, no heat is being supplied to the Aqua-Hot's Boiler Tank.

**NOTE:** The Aqua-Hot's VDC / VAC Control Thermostat will automatically activate the Diesel-Burner and/or the Electric Heating Element(s), **only** if the Diesel and/or Electric switch is in the **ON** position. In order to heat your motorhome / domestic hot water, simply choose the desired heat source(s) and leave the switch(s) (i.e., Diesel and/or Electric) **ON**.

#### **Electric Heating Element Status Indicator Light:**

This indicator light will illuminate GREEN whenever the Aqua-Hot's Electric Heating Element(s) is operating and providing heat to the Aqua-Hot's Boiler Tank. Please note that this light will only be active if the Electric switch is in the **ON** position. If this indicator light illuminates RED, it indicates an electrical overload condition (i.e., short) has occurred in the Electric Heating Element's VDC powered circuitry.

# WARRANTY INFORMATION

---

## - FOR AQUA-HOT MODELS -

Vehicle Systems, Inc. warrants the AQUA-HOT Heater to be free from defects in material and workmanship under normal use and service for a period of two (2) years on both parts and labor commencing upon the original date of registration of the vehicle. The warranty period may not however, exceed 36 months from the original date of delivery by Vehicle Systems, Inc. Replacement parts are warranted for the remainder of the Heater's standard warranty period or for six months (180 days), whichever is greater.

**This warranty is conditional upon proper use of the Heater by the end-user. This warranty does not apply to damage or failure of the AQUA-HOT Heater, or the vehicle into which it was installed, due to improper installation, assembly, maintenance, abuse, neglect, accident, or the use of parts not supplied by Vehicle Systems, Inc. Vehicle Systems is not responsible for incidental or consequential damages.**

The intent of this warranty is to protect the end-user of the heating system from such defects, which would occur in the manufacture of the product. The warranty is not intended to protect the end-user from problems, which are outside the ability of Vehicle Systems' control.

To obtain warranty repair authorization or for additional product information, please contact the **Technical Support Department at 1-800-685-4298 (8 AM to 5 PM Mountain Standard Time).**





**-MEMO-**

---

**-MEMO-**

---

# Vehicle Systems

---

I N C O R P O R A T E D

*Motor Coach Heating Specialist · Manufacturer and Distributor*

15549 East Highway 52 · Fort Lupton, Colorado 80621 · 1-800-685-4298 · Fax: 303-857-9000

© Copyright 2003 Vehicle Systems, Inc. All rights reserved

**[www.vehiclesys.com](http://www.vehiclesys.com)**

LTE-LMA-304